

UMA Automatic Mass Comparator

Class-leading automatic mass comparator

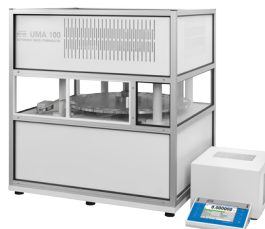

UMA-5



UMA-100

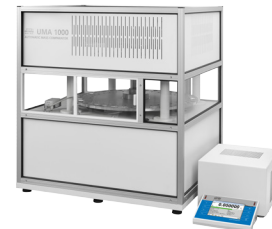

UMA-1000

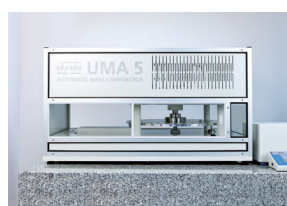

Compact dimensions make the device suitable for any workstation



Insert design enables comparison of weights of various shapes

Functions



Mass comparator



Ambient conditions measurement



Proximity sensors



Replaceable units



Multilingual menu

Features

Effective and Excellent Measurement

The UMA series stands for a class-leading automatic mass comparator. These comparators enable comparison of 1 mg - 1000 g weights of class E1 and lower.

Comparison of Mass Standard Sets

The UMA mass comparator is equipped with either 18-position or 36-position magazine. This universal solution enables comparison of whole weight sets during one process, however using it you can also compare weights of the same mass.

Excellent Measurement Repeatability

UMA automatic mass comparator, due to the elimination of the human factor, temperature changes and air drafts, guarantees excellent measurement repeatability.

Vibration Sensor

With vibration sensor placed inside the electronics, the UMA mass comparators analyse and identify vibration sources. The sensor helps to determine whether the recorded vibrations influence the measurement result or not.







Dedicated Software

Thanks to a user-friendly and functional software the user can prepare complete calibration schedule within just a few minutes.

Universal Insert Shape

Insert design allows measurement of weight of very small mass with high accuracy and prevents weight jamming. The device enables comparison of weight of various shapes using just one universal insert.

Technical Specifications

	UMA-5	UMA-100	UMA-1000
OIML calibration range E1	 1 mg ÷ 5 g	1 g ÷ 100 g	100 g ÷ 1000 g
OIML calibration range E2	 1 mg ÷ 5 g	1 g ÷ 100 g	10 g ÷ 1000 g
OIML calibration range F1	 1 mg ÷ 5 g	1 g ÷ 100 g	10 g ÷ 1000 g
OIML calibration range F2	 1 mg ÷ 5 g	1 g ÷ 100 g	10 g ÷ 1000 g
OIML calibration range M1	 1 mg ÷ 5 g	1 g ÷ 100 g	10 g ÷ 1000 g
OIML calibration range M2	 1 mg ÷ 5 g	1 g ÷ 100 g	10 g ÷ 1000 g
Maximum capacity [Max]	5.1 g	110 g	1060 g
Readability [d]	0.1 µg	0.001 mg	0.005 mg
Repeatability for small load*	0.2 µg (1 mg ÷ 1 g) 0.3 µg (1 g ÷ 2 g)	0.002 mg (1 g)	0.012 mg (10 g)
Repeatability for nominal load *	0.4 µg (2 g ÷ 5 g)	0.002 mg (100 g)	0.012 mg (1000 g)
Stabilization time	30 s	30 s	30 s
Adjustment	internal	internal	internal
Electric compensation range	0 ÷ 5.1 g	- 1 g ÷ 10 g	- 10 g ÷ +60 g
Internal supplementary weights	—	automatic	automatic
Eccentricity (for test weight)	0 µg	0 mg	0 mg
Magazine positions	36 positions	36 positions	18 positions
Display	5.7" colour resistive touch screen	5.7" colour resistive touch screen	5.7" colour resistive touch screen
Keypad	8 keys	8 keys	8 keys
Ingress protection - indicator	IP 43	IP 43	IP 43
Touch-free operation	2 programmable sensors	2 programmable sensors	2 programmable sensors
USB-A	2	2	2
Ethernet	10 / 100 Mbit	10 / 100 Mbit	10 / 100 Mbit
RS 232	2	2	2
Wireless Connection	802.11 b/g/n	802.11 b/g/n	802.11 b/g/n
IN/OUT	4 × IN, 4 × OUT	4 × IN, 4 × OUT	4 × IN, 4 × OUT
Power supply	110 ÷ 230 V AC / 50 ÷ 60 Hz	110 ÷ 230 V AC / 50 ÷ 60 Hz	110 ÷ 230 V AC / 50 ÷ 60 Hz
Operating temperature	+15 ÷ +30 °C	+15 ÷ +30 °C	+15 ÷ +30 °C
Operating temperature change rate	±0.5 °C / 12 h (± 0.3 °C / 4 h)	±0.5 °C / 12 h (± 0.3 °C / 4 h)	±0.5 °C / 12 h (± 0.3 °C / 4 h)
Relative humidity variations	±2% / 4 h	±2% / 4 h	±2% / 4 h
Relative humidity***	40 ÷ 60%	40 ÷ 60%	40 ÷ 60%
Transport and storage temperature	-20 ÷ +50 °C	-20 ÷ +50 °C	-20 ÷ +50 °C
Weighing pan dimensions	ø 20 mm	ø 21 mm	ø 48 mm
Mass comparator dimensions**	900 × 535 × 585 mm	700 × 775 × 585 mm	700 × 775 × 585 mm
Indicator dimensions****	465 × 187 × 261 mm	465 × 187 × 261 mm	465 × 187 × 261 mm
Control unit net weight	8 kg	8 kg	8 kg
Control unit gross weight	18.5 kg	18.5 kg	18.5 kg
Mass comparator net weight	102 kg	113.5 kg	115 kg
Mass comparator gross weight	198.5 kg	219.5 kg	221 kg
Control unit dimensions****	421 × 371 × 421 mm	421 × 371 × 421 mm	421 × 371 × 421 mm
Mass comparator packaging dimensions**	1200 × 800 × 860 mm	1200 × 1000 × 1150 mm	1200 × 1000 × 1150 mm

* repeatability is expressed as a standard deviation determined for 6 ABBA cycles

** dimensions: length x width x height

*** non-condensing conditions

**** control unit (indicator + electronics) is shipped in a separate box

Dimensions

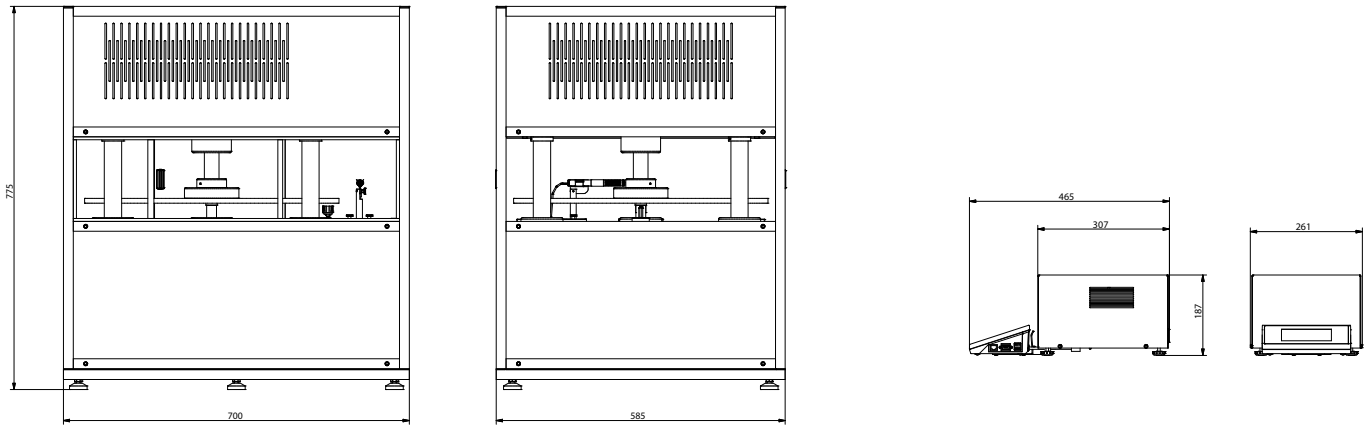

UMA-100, UMA-1000

UMA-control unit

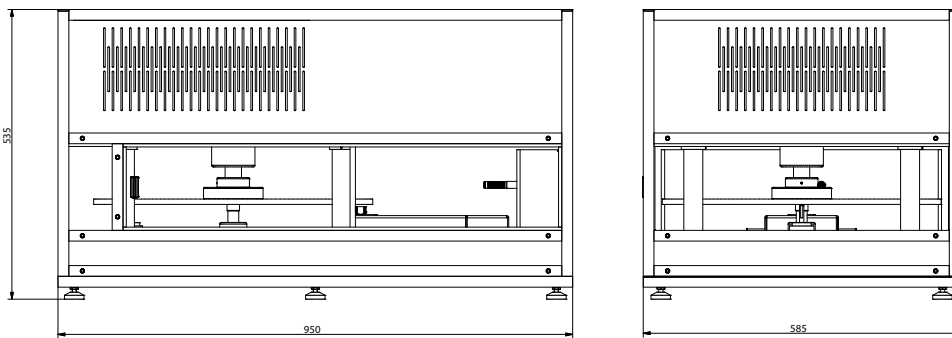

UMA-5

Accessories

Weighing Tables

- granite anti-vibration table

Ambient Conditions

- THB-S or THB-P sensor

Peripheral Devices

- Epson dot matrix printer
- barcode scanner
- WD-5/3Y LCD display (backlit)

Cables, Converters

- RS-232 – P0108 computer cable
- RS-232 – P0167 computer cable
- RS-232 – P0151 Epson printer cable

Electrical Accessories

- power supply with ZR-02 battery

Dedicated Software

RMCS System

- performance of calibration procedures in a laboratory from the moment the order is placed, to the moment of issuing a calibration certificate
- compatible with THB sensors enabling recording ambient conditions
- export of report results to various files
- archiving calibration protocols, orders, certificates and ambient conditions

RADWAG Remote Desktop

- remote control of the mass comparator using computer, telephone or tablet
- sending text messages
- version for Windows 10 and Android systems

R-LAB

- collecting measurements
- carrying out statistical analysis of measurements
- customized graphs and reports

Parameters Editor

- remote change of parameters
- remote on-line preview of the display
- displaying current mass indication
- software update
- file loading, editing and saving parameters to a file
- import and export of parameters
- interfaces: RS232, Ethernet and Wireless Connection
- quick and easy edition of balance parameters using computer