

User Manual

Manual number:
ITKU-10-04-03-15-A

WPW/T scales for fast loads control

WPW Multifunctional scales

WPW/D dosing scales



**MANUFACTURER OF ELECTRONIC
WEIGHING INSTRUMENTS**

RADWAG 26 – 600 Bracka 28 Street - POLAND
Radom, phone +48 48 384 88 00, phone/fax +48 48 385 00 10,
Sales Department +4848 366 80 06
www.radwag.com

MARCH 2015

Table OF CONTENTS

1. INTENDED USE	7
2. PRECAUTIONARY MEASURES	8
2.1. Precautions	8
2.2. Accumulator / battery pack	8
2.3. Operation in a strong electrostatic field	9
2.4. Washing scales intended for meat processing industry	9
3. WARRANTY CONDITIONS	11
4. MAIN DIMENSIONS	12
5. DESCRIPTON OF CONNECTORS	12
6. UNPACKING AND MOUNTING	13
7. GETTING STARTED	13
8. KEYBOARD	14
9. PICTOGRAMS	14
9.1. Battery charge indication	15
10. FUCTIONS OF KEYS	15
11. MENU - PARAMETERS	16
11.1. Overview of parameters	16
11.2. Navigating within the menu level	20
11.2.1. Keyboard	20
11.2.2. Quick access	21
11.3. Return to weighing	21
12. WEIGHING	22
12.1. Operating conditions	22
12.2. Tarring	23
12.3. Inscribing tare value	23
12.4. Zeroing	24
12.5. Weighings in two ranges	25
12.6. Toggling between weight units	25
12.6.1. Selection of basic unit	25
12.6.2. Toggling between weight units	26
12.7. Switching between platforms	26
13. MAIN PARAMETERS	27
13.1. Filtering level	27
13.2. Median filter	28
13.3. Dosing filter setting	28
13.4. Minimal mass parameter	30
13.5. Tare function	31
13.6. Autozero	32
14. PORTS PARAMETERS	33
14.1. RS 232, RS 485 setting	33
14.1.1. Baud rate of RS 232	33
14.1.2. Baud rate of RS 485	34
14.1.3. RS 232 parameters	35
14.1.4. Setting of RS 485 parameters	36
14.2. ETHERNET setting	37
15. EXTERNAL DEVICES	38
15.1. Cooperation with a computer	38
15.1.1. Select the communication port scale-computer	38
15.1.2. Type of printout scale – computer	39
15.1.3. Address setting	40
15.1.4. Order operating of communication protocol	40
15.1.5. Cooperation with „E2R System“	41
15.1.5.1. Enabling „E2R System“	41
15.1.5.2. Buffer for weighings	42
15.1.5.3. The lock of product change	43
15.2. Cooperation with printers	43
15.2.1. Communication port scale - printer	43
15.3. Cooperation with a barcode scanner	44

15.3.1. Select a communication port for the scanner.....	44
15.3.2. Setting the START parameter.....	45
15.3.3. Setting the LENGTH parameter.....	46
15.4. Cooperation with a transponder card reader.....	46
15.4.1. Selecting of communication port.....	47
15.4.2. Procedure of ascribing card numbers to operators.....	47
15.5. Cooperation with an additional display.....	48
15.5.1. Selecting a communication port.....	48
15.5.2. Selecting an additional display type.....	49
16. DATE / TIME SETTING.....	50
16.1. Time view.....	50
16.2. Time setting.....	50
16.3. Date format.....	51
17. PRINTOUTS.....	52
17.1. Printout type.....	52
17.2. Printout of stable / unstable data.....	53
17.3. Checkweighing mode.....	54
17.4. Non-standard printouts.....	55
17.5. Designing non-standard printouts.....	55
17.6. Texts in non-standard printouts.....	56
17.6.1. Code format.....	56
17.6.2. Variables appearing in all modes.....	57
17.6.3. Variables for printing out weighings from the database.....	58
17.6.4. Variables for printouts of reports from weighings.....	59
17.6.5. Special characters that can be used in non-standard printouts.....	60
18. DATABASES.....	60
18.1. Logging in.....	60
18.2. Access level.....	62
18.2.1. Access level to edition of databases.....	62
18.2.2. Access level for disabled logging.....	62
18.3. Password type.....	63
18.4. Type of codes.....	64
18.5. Access to edition of databases.....	65
18.6. Quick searching in databases.....	65
18.6.1. Quick code search.....	66
18.6.2. Quick name search.....	66
18.6.3. Quick number search.....	67
18.7. User database.....	68
18.8. Assortment database.....	70
18.9. Weighings database.....	72
18.10. Database of tare values.....	73
18.11. General purpose variables.....	74
18.11.1. Editing general purpose variables.....	74
18.11.2. General purpose variables in printouts.....	75
19. REPORTS FROM WEIGHINGS.....	76
19.1. Editing reports.....	76
19.2. Printouts of reports.....	77
20. CONFIGURATION OF EXTERNAL INPUTS / OUTPUTS.....	78
20.1. Configuration of external buttons.....	78
20.2. Configuration of outputs.....	79
21. STATISTICS.....	80
21.1. Updating statistics.....	80
21.2. Printouts of statistics.....	81
21.3. Zeroing statistics.....	82
22. OTHER PARAMETERS.....	83
22.1. Language setting.....	83
22.2. LED power setting.....	84
22.3. Work modes for LEDs.....	84
22.4. Automatic power down.....	86
22.5. Backlight.....	87
22.5.1. Backlight – power supply from mains.....	87

22.5.2. Backlight - power supply from the accumulator	88
22.6. "Beep" sound – key-press reaction	88
22.7. Keypad modes	89
22.8. Software version view	90
23. SCALE CALIBRATION	90
23.1. Calibration procedure	91
23.2. Start mass adjustment	92
24. WORK MODES	93
24.1. Accessibility of work modes	93
24.2. Programmable keys	94
24.3. +/- control according to an inscribed standard mass	96
24.4. Maximal force latch	98
24.5. Counting pieces	98
24.5.1. Enabling work modes	99
24.5.2. Setting standard mass by inscribing the mass of a single piece	99
24.5.3. Setting the standard mass by declaring the quantity of a sample	100
24.6. Deviation in percents in relation to a standard mass	101
24.6.1. Starting weighing in per cents	101
24.6.2. Weighing a standard mass	101
24.6.3. Inscribing a standard mass	102
24.7. Weighing animals	103
24.7.1. Weighing time setting	103
24.7.2. Starting the work mode	104
24.7.3. Procedure of weighing animals	104
24.8. Dosing	105
24.8.1. Dosing mode setting	105
24.8.2. Time interval between changing dosage thresholds	106
24.8.3. Time interval completing process	106
24.8.4. Mode for OUTPUTS	107
24.8.5. Tarring mode setting	108
24.8.6. Corrections	108
24.8.6.1. Correction mode	109
24.8.6.2. Initial correction value	109
24.8.6.3. Maximum correctional value	110
24.8.6.4. Averaging from subsequent dosing cycles	111
24.8.7. Starting work modes	112
25. DIAGRAMS OF CONNECTION CABLES	113
26. CONNECTORS	115
26.1. 3IN/3OUT connector	115
26.2. RS232, RS485 connector	116
27. SPECIFICATION OF ADDITIONAL MODULES	117
27.1. Ethernet module - ET	118
27.1.1. Mounting way in PUE C41H	119
27.1.2. Drawings of sockets and cables for Ethernet	121
27.2. Module of Analogue Outputs	121
27.2.1. Technical specification	122
27.2.2. The way of installing inside PUE C41H	122
27.2.3. Configuration of work modes of analogue modules	123
27.2.4. Connections to AN module	124
27.3. Relay module - PK1	125
27.3.1. Technical specification	125
27.3.2. Installing in PUE C41H indicators	125
27.3.3. Drawing of cables and outputs	127
27.4. WE 4 - 4 inputs / 4 outputs module	127
27.4.1. Technical specification	127
27.4.2. Colours of cables for I/O	128
27.4.3. Installing method in PUE C41H indicators	128
27.5. WE 8 - 8 inputs / 8 outputs module	129
27.5.1. Technical specification	130
27.5.2. Installing method in PUE C41H indicators	130
27.5.3. I/O diagram	131

27.5.4. Description of input output wires	132
27.6. DP1 – module for an additional platform	132
27.6.1. Technical specification	133
27.6.2. Colours of wires	133
27.6.3. Connecting additional platforms	134
27.6.4. Installing in PUE C41H housing	136
27.7. RS485 led out via RS 1D gland	138
27.7.1. Installing inside the PUE C41H housing	138
27.7.2. RS 485 - PT0012 cable drawing	139
28. COMMUNICATION PROTOCOL	140
28.1. General information	140
28.2. A set of commands for RS interfaces	140
28.3. Respond message format	141
28.4. Command's description	141
28.4.1. Zeroing	141
28.4.2. Tarring	142
28.4.3. Get tare value	142
28.4.4. Set tare value	143
28.4.5. Send the stable result in basic unit	143
28.4.6. Send the result immediately in basic unit	144
28.4.7. Get immediate results from both platforms in basic units	144
28.4.8. Send the stable result in current unit	145
28.4.9. Send the result immediately in current unit	146
28.4.10. Switch on continuous transmission in basic unit	146
28.4.11. Switch off continuous transmission in basic unit	147
28.4.12. Switch on continuous transmission in current unit	147
28.4.13. Switch off continuous transmission in current unit	147
28.4.14. Lock the scale keyboard	148
28.4.15. Unlock the scale keyboard	148
28.4.16. Initiating of dosing/filling	148
28.4.17. Stop of dosing/filling	148
28.4.18. Set lower threshold	148
28.4.19. Set upper threshold	149
28.4.20. Read lower threshold	149
28.4.21. Read upper threshold	149
28.4.22. Send all implemented commands	150
28.5. Manual printouts / automatic printouts	150
28.6. Continuous transmission	151
28.7. Configuring printouts	151
29. ERROR MESSAGES	152
30. TROUBLE SHOOTING	152
31. TECHNICAL PARAMETERS	153
31.1. Scales for +/- control	153
31.2. Multifunctional scales of WPW series	154
31.3. Multifunctional scales of WPW/H series	155
31.4. Dosing scales of WPW/D series	156
31.5. Dosing scales of WPW/D/H series	157
32. APPENDIX	159
32.1. Communication with barcode scanners	159
32.2. Cooperation with „EDYTOR WPW“ – PC software tool	160
32.2.1. Main window	160
32.2.2. Setting RS232 parameters	161
32.2.3. Setting Ethernet parameters	162
32.3. Example of dosing application	163
32.4. Example of designing non-standard printouts	165
32.5. Example of creating a complex report	165
32.6. Examples of surge protections	168

1. INTENDED USE

Scales with PUE C41H terminal are industrial scales with a possibility of working in high humidity and a wide temperature range $-10 \div 40^{\circ}\text{C}$. The terminal is equipped with fields of LEDs (light emitting diodes). Tarring within the whole range of measurement allows to determine the net mass of loads.

Functions:

- Tarring within the whole measuring range,
- Inscribing tare value,
- Automatic tare,
- Automatic print,
- Continuous transmission,
- Printout configuration (stable/immediate),
- Designing printouts,
- Minima mass,
- Force measurements in Newtons,
- Cooperation with computers,
- Cooperation with printers,
- Cooperation with external industrial buttons ZERO, TARA, PRINT,
- Cooperation with a barcode scanner,
- Cooperation with a transponder card reader,
- Totalizing,
- +/- control (checkweighing),
- Deviation in percents,
- Top mass latch,
- Dosing,
- Counting pieces,
- Weighings animals.

User functions may have attribute of accessibility. For this reason it is possible to adjust scale to individual needs to provide access to only these functions which are currently needed. Attribute determination accessible / inaccessible is possible in user menu and described in further part of manual.

2. PRECAUTIONARY MEASURES

2.1. Precautions

- A. Please, read carefully this user manual before and use the device according to its intended use,
- B. Devices that are to be withdrawn from usage should be sent back to the producer or in case of own utilization do it according to the law.

2.2. Accumulator / battery pack

WPW scales include gel cell accumulators **SLA** (*Sealed Lead Acid type*) **6V 3 to 4Ah** of capacity. The device connected to mains intelligently monitors the battery state and charges it if possible. After sudden lack of power supply from the mains the device automatically switches to accumulator without breaking operation.



In case of an prolonged storage period in low temperatures, it is not allowed the full discharge of the accompanied batteries.



The worn out accumulator can be exchanged to a new one by the authorized service of the manufacturer.



The equipment including accumulators does not belong to your regular household waste. The European legislation requires that electrical and electronic equipment be collected and disposed separately from other communal waste with the aim of being recycled.

Notice:

Some symbols on accumulators identify harmful elements:

Pb = lead,

Cd = cadmium,

Hg = mercury.

2.3. Operation in a strong electrostatic field

If the device is about to operate in a strong electrostatic field (e.g. printing houses etc.) it should be connected to the earthing. Connect it to the clamp terminal signed \perp .

2.4. Washing scales intended for meat processing industry

Weighing platforms are made of stainless steel (according to standards PN-0H18N9, EN-1.4301, AISI-304) and silicon elements.

There is an exception, zinc coated overhead scales and painted livestock scales made of mild constructional steel with aluminium cover plate on the platform, polyester overlays and stainless steel or polyamide glands.

Caution:

Washing and disinfection agents should be matched to the scale.

Platforms of ramp and livestock scales as well as load-bearing structures and weighing tracks of overhead scales can be washed with jet of water (temp. up to +80°C) with an appropriate washing agent. Washing measuring indicators/weighing terminals with the jet of hot water is not allowed.

Caution:

It is advisable to cover measuring indicators/weighing terminals while washing their surrounding with the jet of water.

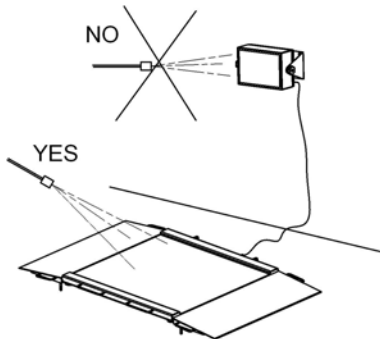

To wash waterproof platform scales and indicators/terminals neither jet of water nor hot water shall be used, in order not to damage the silicon gaiter that covers the load cell inside the platform and the overlay or glands in the indicator/terminal. To wash pans of platform scales they should be taken off first. Then they can be washed either with the jet of water or by immersion.

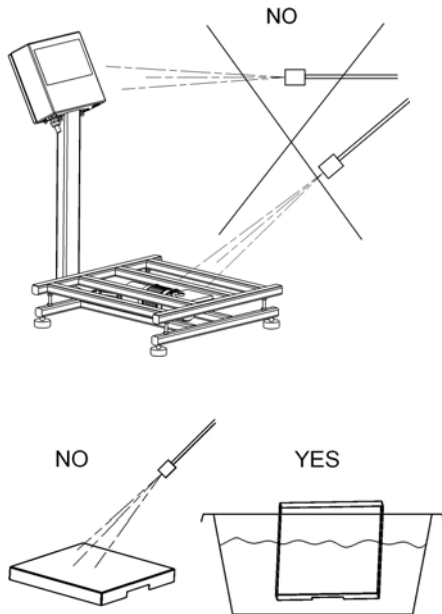

Type:		Water with detergent	Jet of water	Hot water – max 80°C
Ramp scales	Platforms with tracks	yes	yes	yes
	Indicator/terminal	yes	no	no
Livestock scales	Platform with railing	yes	yes	yes
	Indicator/terminal	yes	no	no
Overhead scales	Load bearing structure with the load cell	yes	yes	yes
	Indicator/terminal	yes	no	no
Platform waterproof scales	Platform	yes	no	no
	Indicator/terminal	yes	no	no
	Taken off pan	yes	yes	yes

3. WARRANTY CONDITIONS

- A. RADWAG is obliged to repair or change those elements that appears to be faulty because of production and construction reason,
- B. Defining defects of unclear origin and outlining methods of elimination can be settled only in participation of a user and the manufacturer representatives,
- C. RADWAG does not take any responsibility connected with destructions or losses derives from non-authorized or inappropriate (not adequate to manuals) production or service procedures,
- D. Warranty does not cover:
 - Mechanical failures caused by inappropriate maintenance of the device or failures of thermal or chemical origin or caused by atmospheric discharge, overvoltage in mains or other random event,
 - Inappropriate cleaning.
- E. Loss of warranty appears after:
 - Access by an unauthorized service,
 - Intrusion into mechanical or electronic construction of unauthorized people,
 - Removing or destroying protection stickers.
- F. The detailed warranty conditions one can find in warranty certificate.
- G. Contact with the central authorized service:
+48 48 384 88 00 ext. 106 or 107.

4. MAIN DIMENSIONS

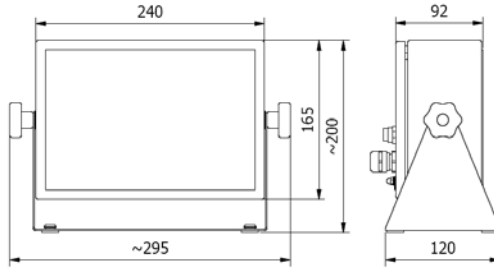

Main dimensions of PUE C41H

5. DESCRIPTION OF CONNECTORS

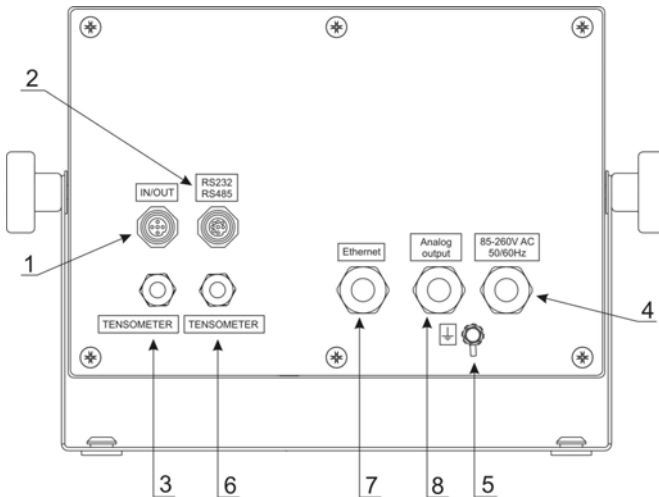

Terminal connectors

- 1 – I/O connectors
- 2 – RS232, RS485 connector
- 3 – Tensometer gland
- 4 – Power supply gland
- 5 – Earthing terminal
- 6 – Additional platform gland (option)
- 7 – Ethernet gland (option)
- 8 – analogue output gland - voltage or current loop (option)

Notice:

In accordance to the number of mounted modules the number and the placement of glands and connectors can vary. Connectors and glands mentioned in the standard solution appears in every option in the same place regardless of the option.

6. UNPACKING AND MOUNTING

- A. Take the device out of the package,
- B. Put the scale on an even stiff ground,
- C. Level the platform using an external or internal level condition indicator. Use levelling feet to do it.

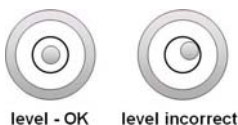

7. GETTING STARTED

- Switch off the scale using  – keep pressing it for about 0.5 sec,
- Wait for the test completion,
- Then you will see zero indication and following pictograms displayed:

 - zero

 - equilibrium

kg - weight unit

If the indication is not zero – press zero button.

8. KEYBOARD

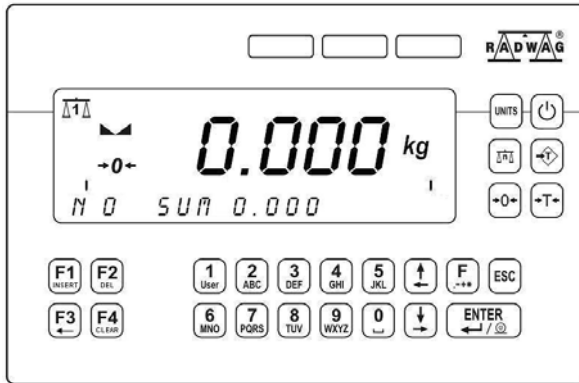







9. PICTOGRAMS











No	Pictogram	Description
1.		Zero indication (Autozero zone)
2.		Equilibrium
3.	kg (g)	Weighing mode
4.		Battery/accumulator
5.	Net	Tare has been introduced
6.	Min	Lower threshold
7.	OK	Proper mass
8.	Max	Upper threshold or TOP mode
9.		Counting pieces
10.	%	Weighings in percents
11.		Animals weighings
12.		Dosing
13.		Bargraph
14.		First platform
15.		Second platform
16.		Second range of weightings'
17.		Communication with a computer













9.1. Battery charge indication

 pictogram is situated in the upper right corner informed about the discharge level or charging process:

-  pictogram blinks: accumulator damaged or no accumulator,
-  pictogram displayed continuously: it is charge between 70% and 100%,
-  pictogram displayed continuously: it is charge between 30% and 70%,
-  pictogram displayed continuously: it is discharge (less than 30%), connect to the mains to charge,
- Internal elements of  pictograms are displayed in sequence: charging,
- No  pictogram: power supply from mains, battery charges.

10. FUNCTIONS OF KEYS

Keys	Description
	Turning on/off the scale
	Toggling between weight units
	Changing active platform
	Inscribing tare value
	Zeroing
	Tarring
	Function key (entering the menu)
	Leaving a function without saving or reaching a higher level of the menu
	Printing out the result or confirming some entered data
	Selection / viewing of articles from the assortment database

	Selection purpose variables
 ... 	N/A
	Work mode selection
	N/A
	Log out
	Inscribing MIN, MAX thresholds
	View of statistics
 ... 	N/A
 ... 	Programmable keys

Caution:

After pressing , functions of keys change while in the menu. The way of using them is described farther.

11. MENU - PARAMETERS

11.1. Overview of parameters

The menu has been divided into **10** basic groups. Each group has its individual name starting with the capital letter **P**. Names of groups and their contents are shown below.

PARAMETERS

P 1 SCALE PARAMETERS

P 1.1 PLATFORM 1 PAR.	
P 1.1.1 FITER	AVERAGE
P 1.1.2 MED. FILTER	YES
P 1.1.3 LO THRESH.	20 d
P 1.1.4 TARE MODE	STDRD
P 1.1.5 START UNIT	kg
P 1.1.6 AUTOZERO	YES
P 1.1.7 DOS. FILTER	1
P 1.2 PLATFORM 2 PAR.	

P 1.2.1	FILTER		AVERAGE
P 1.2.2	MED. FILTER		YES
P 1.2.3	LO THRESH.		20 d
P 1.2.4	TARE MODE		STDRD
P 1.2.5	BASIC UNIT		kg
P 1.2.6	AUTOZERO		YES
P 1.2.7	DOS. FILTER		1
P 1.3	FACTORY NO		0

P 2 COM PORTS PARAMETERS

P 2.1	RS 485		
P 2.1.1	BAUD RATE		9600
P 2.1.2	DATA BITS		8
P 2.1.3	PARITY BIT		NO
P 2.1.4	STOP BITS		1
P 2.2	RS 232 (1)		
P 2.2.1	BAUD RATE		9600
P 2.2.2	DATA BITS		8
P 2.2.3	PARITY BIT		NO
P 2.2.4	STOP BITS		1
P 2.3	RS 232 (2)		
P 2.3.1	BAUD RATE		9600
P 2.3.2	PARITY BIT		NO
P 2.4	ETHERNET		
P 2.4.1	COMM MODE		SERVER
P 2.4.2	IP ADDRESS		192.168.0.2
P 2.4.3	SUBNET MSK.		255.255.255.0
P 2.4.4	GATEWAY		192.168.0.1
P 2.4.5	LOCALPORT		4001
P 2.4.6	HOST IP		192.168.0.3
P 2.4.7	HOST PORT		2000
P 2.4.8	TIMEOUT		60

P 3 DEVICES

P 3.1	COMPUTER		
P 3.1.1	COMP.PORT		NO
P 3.1.2	ADDRESS		1
P 3.1.3	COMP. PRINT		NONE
P 3.1.4	BASIC TRS.		YES
P 3.1.5	SYSTEM E2R		NO
P 3.1.5	E2R SYSTEM		
P 3.1.5.1	ACTIVE SYS.		NO
P 3.1.5.1	WEIGH. BUFFER		0
P 3.1.5.1	LOCK ASSOR.		NO
P 3.2.1	PRINT PORT		NO
P 3.3	BARCODE SCANNER		
P 3.3.1	BARCOD. COM		NO
P 3.3.2	START		0
P 3.3.3	LENGTH		0
P 3.4	TRANSP. CARD READER		
P 3.4.1	READER COM		NO

P 3.5	ADDITIONAL DISPLAY	
P 3.5.1	DISPL. PORT	NO
P 3.5.2	DISPL. TYPE	LCD
P 4	DATE / TIME	
P 4.1	DISPL. TIME	* FUNCTION *
P 4.2	SET TIME	* FUNCTION *
P 4.3	DAT. FORMAT	YY-MM-DD
P 5	PRINTOUTS	
P 5.1	AUTO. PRINT	WHEN STAB
P 5.2	STAB. PRINT	YES
P 5.3	CHECKWEIGHING	NO
P 5.4	PRINTOUT	STANDARD
P 5.5	PRINTOUT 1	* FUNCTION *
P 5.6	PRINTOUT 2	* FUNCTION *
P 5.7	PRINTOUT 3	* FUNCTION *
P 5.8	PRINTOUT 4	* FUNCTION *
P 6	DATABASES	
P 6.1	LOGGING	NO
P 6.2	EDITION	ADMIN
P 6.3	ANON. ACC.	ADMIN
P 6.4	PASS. TYPE	NUM
P 6.5	CODE TYPE	NUM
P 6.6	STATISTICS	GENERAL
P 7	WORK MODES	
P 7.1	MODE ACCES.	
P 7.1.1	WEIGHING	YES
P 7.1.2	TOP	YES
P 7.1.3	COUN. PCS	YES
P 7.1.4	CHECKWEIGH.	YES
P 7.1.5	ANIM. WEIGH.	YES
P 7.1.6	DOSAGE	YES
P 7.1.7	INTER. TERM.	YES
P 7.2	BUTTONS FUNCTIONS	
P 7.2.1	B6	NONE
P 7.2.2	B7	NONE
P 7.2.3	B8	NONE
P 7.2.4	B9	NONE
P 7.2.5	B0	NONE
P 7.3	ANIM. WEIGH.	
P 7.3.1	WEIGH. TIME	15
P 7.4	DOSAGE	
P 7.4.1	DOSING NAM.	1
P 7.4.2	DELAY	5
P 7.4.3	CHUTE TIME	5
P 7.4.4	OUTPUT MOD.	1_2
P 7.4.5	TARRING	NO
P 7.4.6	DOSING CORRECTIONS	
P 7.4.6.1	MODE	NONE

P 7.4.6.2	START CORRECTIONS		0.000
P 7.4.6.3	MAX CORRECTIONS		0.000
P 7.4.6.4	AVERAGING VALUE		3

P 8 I/O CONFIG

P 8.1 EXTERNAL BUTTONS

P 8.1.1	TARE BUTT.		NO
P 8.1.2	PRINT BUTT.		NO
P 8.1.3	ZERO BUTT.		NO
P 8.1.4	START BUTT.		NO
P 8.1.5	STOP BUTT.		NO
P 8.1.6	EXT. START		NO
P 8.1.7	TERM. BUTT.		NO
P 8.1.8	CHUTE PERM.		NO

P 8.2 OUTPUT CONF.

P 8.2.1	MIN		NO
P 8.2.2	OK		NO
P 8.2.3	MAX		NO
P 8.2.4	STABLE		NO
P 8.2.5	THRESH 1		NO
P 8.2.6	THRESH 2		NO
P 8.2.7	CHUTE		NO

P 9 OTHER

P 9.1	LANGUAGE		ENGLISH
P 9.2	DIODES		
P 9.2.1	LED POWER		100%
P 9.2.2	RED DIODES		NON-STAB.
P 9.2.3	GREEN DIOD.		STABLE
P 9.3	POWER SAVE		NO
P 9.4	BACKLIGHT		
P 9.4.1	BL MAINS		YES
P 9.4.2	BL BATTER.		100%
P 9.5	BEEP		YES
P 9.6	KEYPAD TYPE		ABC2
P 9.7	SOFT. VER.		WTLS 1.7.5

P 10 USER CALIB.

P 10.1	PLATF. 1 CALIB		
P 10.1.1	STRT M. ADJ.		* FUNCTION *
P 10.1.2	CALIBRATION		* FUNCTION *
P 10.2	PLATF. 2 CALIB		
P 10.2.1	STRT M. ADJ		* FUNCTION *
P 10.2.2	CALIBRATION		* FUNCTION *

11.2. Navigating within the menu level

Use keyboard to browse the menu.

11.2.1. Keyboard



Entering the main menu, special characters in the editing field
Entering the search procedure of records in databases



Moving up (left)



Moving down (right)



Adding records in a database
Adding characters in an editing field



Clearing the editing field
Erasing a record in a database
Selecting and editing general purpose variables



START of dosing procedure
START of weighings animals
Deleting characters in editing field



Clearing editing field
Deleting database
Zeroing statistics





Entering submenus
Entering parameters
Confirming changes



Skipping changes
Leaving the menu level

11.2.2. Quick access

It is possible to move quickly within the parameters' menu using

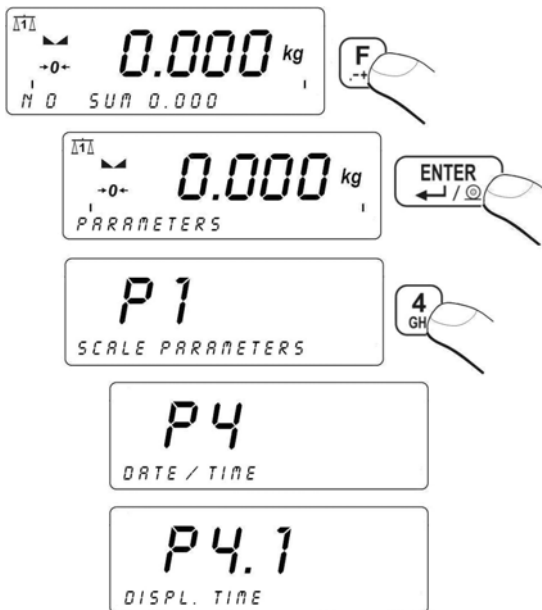

 to .

Procedure:



11.3. Return to weighing



Press , until you see **SAVE CHANGES ?**. Then you press:
 – confirms changes or  – skips changes. Then the scale returns to weighing.

12. WEIGHING

Put a load you want to weigh on the weighing pan. When the  pictogram appears it means that the result is stable and ready to read.

12.1. Operating conditions

In order to assure long-term operation and appropriate measurements of weighted loads following precautions should be taken into consideration:

- Loads should be placed on the pan delicately and carefully in order to avoid mechanical shocks:

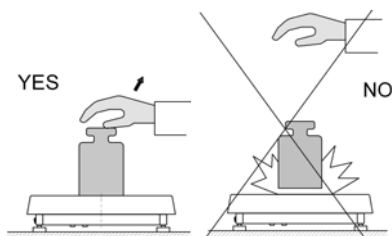

- Loads should be placed centrally on the pan (errors caused by eccentric weighing are outlined by standard PN-EN 45501 ch. 3.5 and 3.6.2):

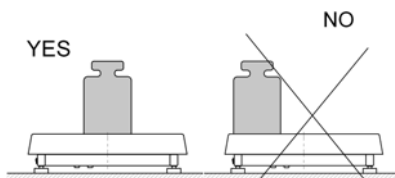

- Do not load the pan with concentrated force:

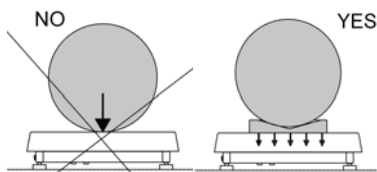

- Avoid side loads, particularly side shocks should be avoided:

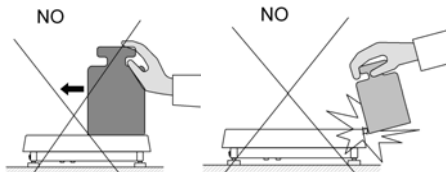

12.2. Tarring

In order to determine the net mass put the packaging on the pan.

After stabilising press -  (**Net** pictogram will be displayed in the left upper corner and zero will be indicated).

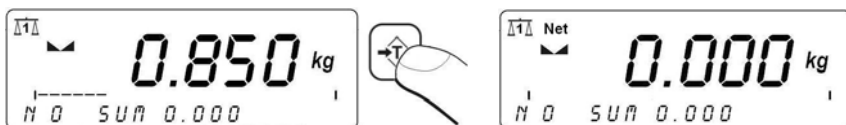

After placing a load on the weight pan net mass will be shown. Tarring is possible within the whole range of the scale. After unloading the pan the display shows the tarred value with minus sign.



Caution:

*Tarring cannot be performed when a negative or zero value is being displayed. In such case **Err3** appears on the display and a short beep sound will be emitted.*

12.3. Inscribing tare value

You can also inscribe a tare value:

Procedure:

While in weighings mode:

- Press ,
- In the lower line you will see an editing field:



- Inscribe the tare value:





- Press ,
- The scale return to weighings mode The inscribed tare value can be seen on the display with „-“ sign.

Tare can be inscribed anytime in weighings mode.

12.4. Zeroing

To **ZERO** the scale press: .

The scale will display zero and following pictograms:  and . Zeroing is only possible within the scope of $\pm 2\%$ of full scale. While zeroing outside the scope of $\pm 2\%$ you will see **Err2**.

Zeroing is possible only in stable state.

Caution:

*Zeroing is possible only within $\pm 2\%$ of full range around zero. If the zeroed value is beyond the interval of $\pm 2\%$, **Err2** is displayed and a short beep sound will be emitted.*

12.5. Weighings in two ranges

Switching between the **I range** and the **II range** happens automatically (exceeding Max of the **I range**).

Weighings in the second range is signalled by a pictogram in the top left corner of the display.

Then weighings is done with the accuracy of the **II range** to the moment of returning to zero (autozero range **+0-**) where the scale switches back to the **I range**.



12.6. Toggling between weight units

12.6.1. Selection of basic unit

This function sets the unit that will be set after powering on.

Procedure:

- While In weighings mode press **F** and then:

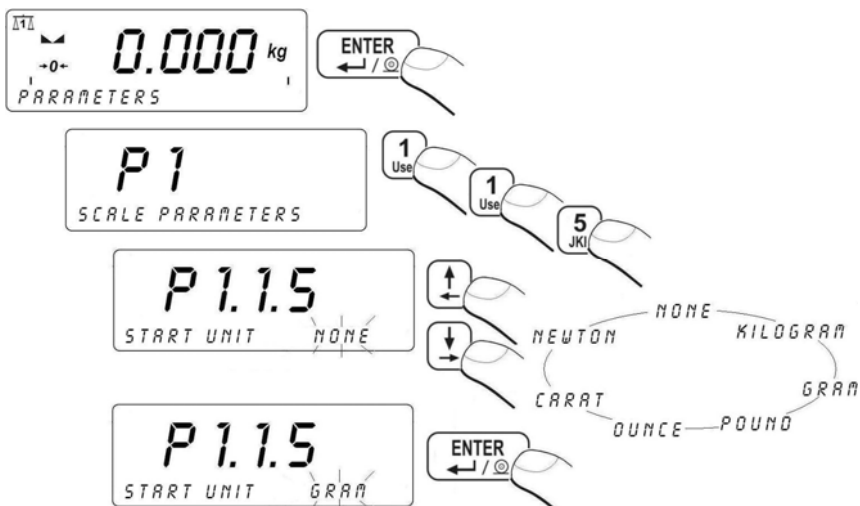

Selection:

- When the main unit is [kg], users can select among: [kg, lb, oz, ct, N, g] , for verified scales [lb, oz, N] are not accessible;
- When the main unit is [g], users can select among: [g, kg, lb, oz, ct, N] , for verified scales [lb, oz, N] are not accessible.

12.6.2. Toggling between weight units

Press the **Units** key to toggle between weight units.



Accessible units:

- When [kg] is the basic unit, users can toggle between: [kg, lb, oz, ct, N, g]. For verified scales [lb, oz, N] are not accessible;
- When [g], is the basic unit, users can toggle between: [g, kg, lb, oz, ct, N] For verified scales [lb, oz, N] are not accessible.

Notice:

The terminal always starts working with the main (calibration) unit.

12.7. Switching between platforms

If a scale is equipped with two platforms press  to change the platform. The active platform is signalled by pictograms in the top left corner of the display.



13. MAIN PARAMETERS

Users can adjust the scale to external ambient conditions (filtering level) or particular needs (autozero operation, tare memory). This parameters are present in **<P1 SCALE PARAMETERS>**.

13.1. Filtering level

Procedure:

- Enter **<P1 SCALE PARAMETERS>** and then:

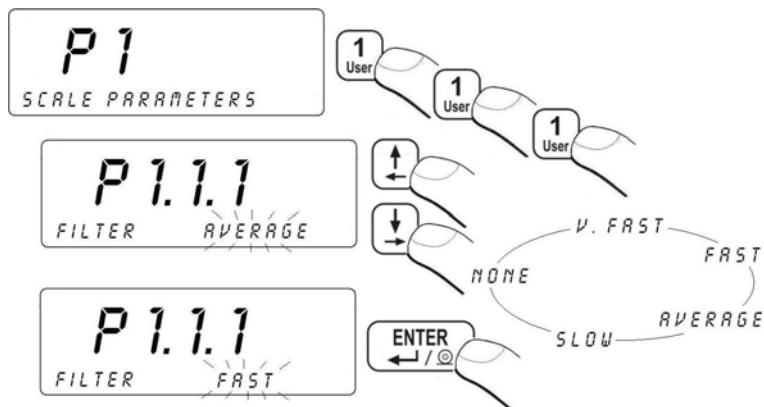

Return to weighing:

See 11.3.

Notice:

The higher filtering level the longer stabilization time.

13.2. Median filter

This filter eliminates short mechanical shocks.

Procedure:

- Enter **<P1 SCALE PARAMETERS>** and then:

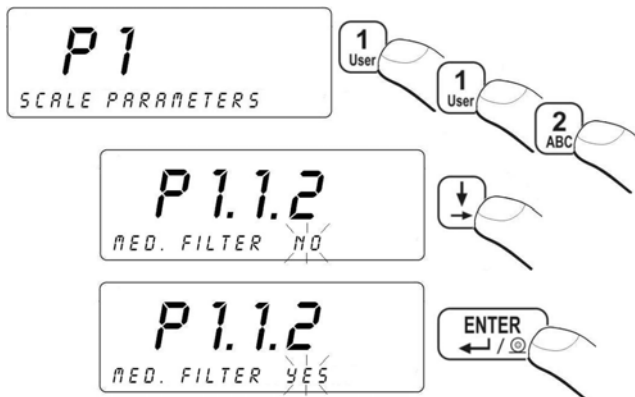

NO - filter disabled
YES - filter enabled

Return to weighing:

See 11.3.

13.3. Dosing filter setting

In PUE 41 terminals a special averaging filter for dosing process has been implemented. The result of this filtration, instead of traditional filters for static weighing, is compared with dosing setpoints. The filter parameter is the number of samples from the A/D converter (1 to 10). When the filter is set to 1 every reading from the A/D converter is compared with the dosing setpoints, which does not introduce any delay. If the filter parameter is set to $n > 1$, the filtering result will be calculated as an arithmetic average from the last n measurements.

$$M = \sum_{i=1}^n X_i$$

, where M is a filtering result from samples X_1 to X_n .

As dosing is a kind of dynamic state, which results in continuous changes in measurements, the averaged number of samples in the filter have an effect on the result. An example situation is illustrated below:

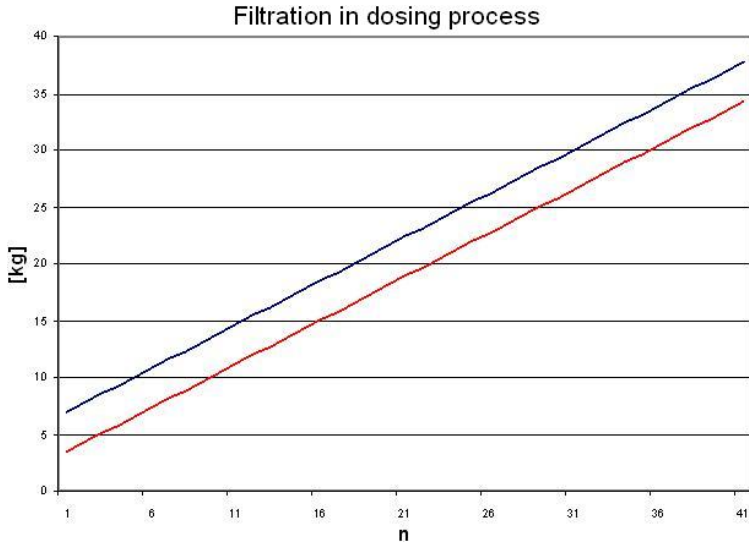

The upper blue line represents results for $n=1$ samples in the filter buffer (averaging is off). The lower red line represents the same process when the filter is set to $n=10$. The difference depends on the dynamics (dosing rate) of changes either. The theory shows that the best filter parameter is $n=1$ because the setpoints can be compared with the current dosed mass. But in practice, there is a noise from different vibration sources registered and sometimes external forces connected with kinetic and potential energy of the poured material. It causes that the filter setting should be matched experimentally.

Caution:

1. The subsequent readouts of the measured value from the A/D converter is performed every 100 ms.
2. This filter operates only in dosing procedures.

Procedure:

- Enter **<P1 SCALE PARAMETERS >** according to 11.2. of the manual:

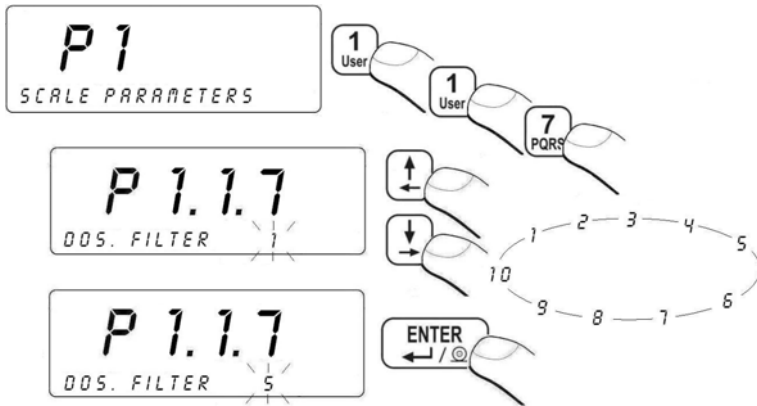

Return to weighing:
See 11.3.

13.4. Minimal mass parameter

Parameter **PROG LO** is related to following functions:

- automatic tare,
- automatic operation,
- weighing animals.

The next automatic tarring can be performed after the indication reaches the gross value below **LO THRESH**.

For automatic weighing the next weighings can be performed after the indication reaches the net value below **LO THRESH**.

The procedure of weighing animals will start after the gross animal mass is greater than **LO THRESH**.

Procedure:

- Enter **<P1 SCALE PARAMETERS>** according to 11.2. and then:

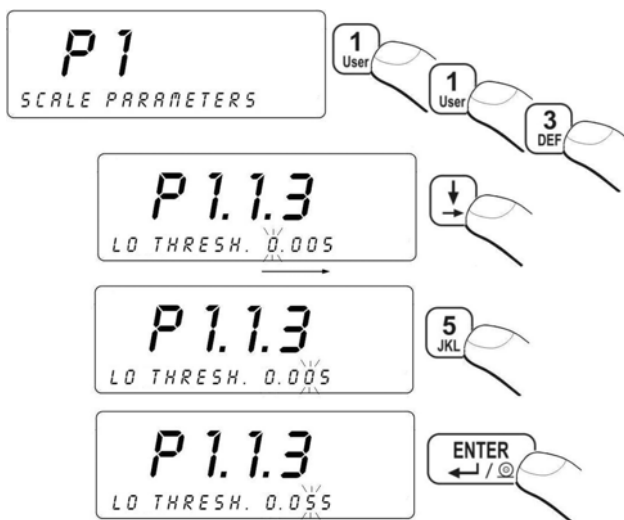

Return to weighing:
See 11.3.

13.5. Tare function

This parameter allows to set appropriate parameters for tarring.

Procedure:

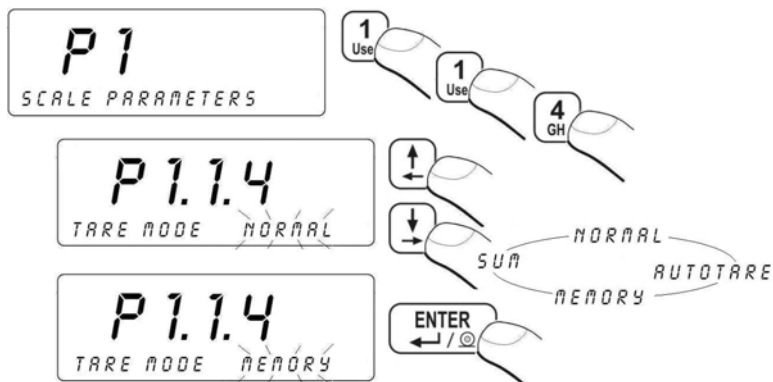

- Enter <P1 SCALE PARAMETERS> according to 11.2. and then:



- AUTO** - disable automatic tare (the mode is remembered after restart);
- NORMAL** - tarring by pressing ;
- MEMORY** - tare memory mode - the last tare value is being kept in a non-volatile memory, **Net** pictogram is displayed.
- SUM** - sum of tares – summing up a product tare value with a tare from the database of tare values or with an inscribed one.

Return to weighing:
See 11.3.

13.6. Autozero

The autozero function has been implemented in order to assure precise indications. This function controls and corrects „0” indication. While the function is active it compares the results continuously with constant frequency. If two sequential results differ less than the declared value of autozero range, so the scale will be automatically zeroed and the pictograms  and  **0**  will be displayed.

When AUTOZERO is disabled zero is not corrected automatically. However, in particular cases, this function can disrupt the measurement process e.g. slow pouring of liquid or powder on the weighing pan. In this case, it is advisable to disable the autozero function.

Procedure:

- Enter **<P1 SCALE PARAMETERS>** according to 11.2. and then:

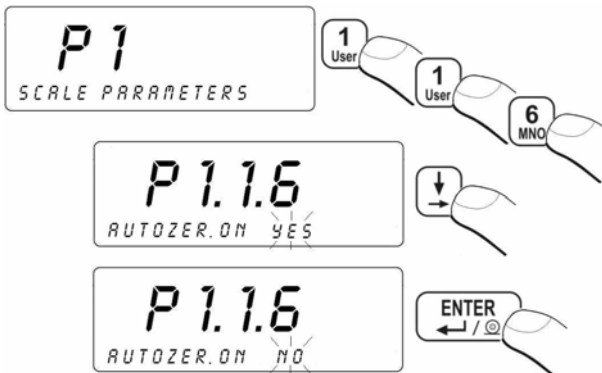

NO - Autozero disabled

YES - Autozero enabled

Return to weighing:

See 11.3.

14. PORTS PARAMETERS

It is possible to connect external devices (printer, computer) to the ports:

- RS 232 (1)
- RS 232 (2)
- RS 485
- Ethernet

Configuration can be done in: **<P2 COM PORTS PARAMETERS>**.

14.1. RS 232, RS 485 setting

For setting: RS 232, RS 485 use following parameters:

- Baud rate - 2400 - 115200 bit / s
- Data bits - 7, 8
- Stop bit - 1, 1.5, 2
- Parity - NONE, ODD, EVEN

Caution:

*There is impossible to set data bits and stop bits for RS 232(2).
They are internally set to 8 bits and 1 stop bit.*

14.1.1. Baud rate of RS 232

Procedure:

- Enter **<P2 COM PORTS PARAMETERS>** according to 11.2. and then:

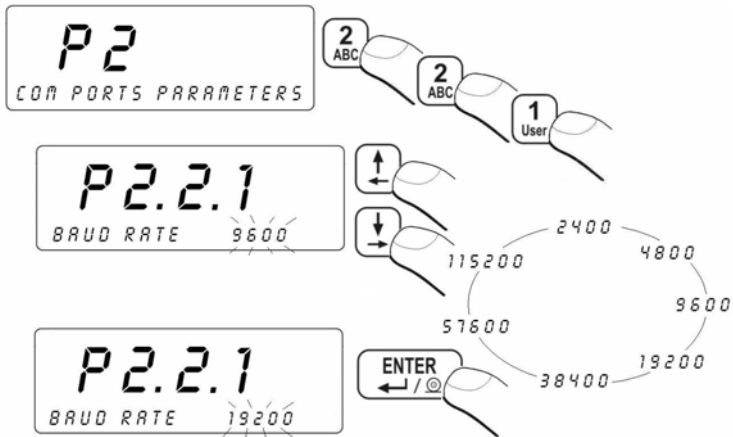

Return to weighing:
See 11.3.

14.1.2. Baud rate of RS 485

Procedure:

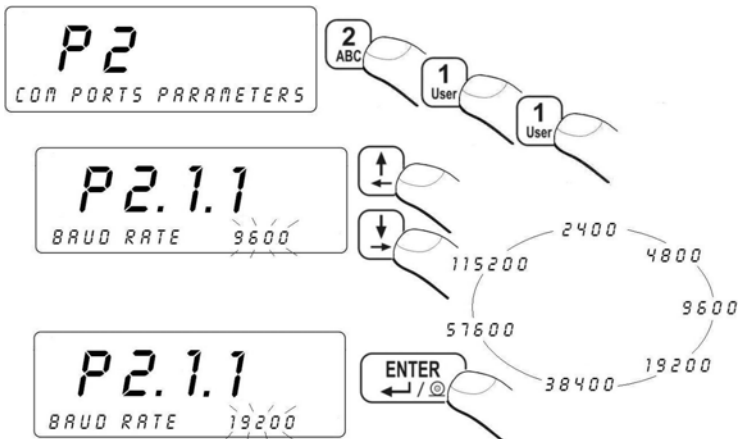

- Enter < **P2 COM PORTS PARAMETERS** > according to 11.2. and then:





Return to weighing:
See 11.3.

14.1.3. RS 232 parameters



Procedure:

- Enter <P2.2 RS232 (1)> and press ,
- Using  scroll to <P2.2.2 DATA BITS> and press :



- The selected value confirm with ,
- Using  go to <P2.2.3 PARITY BIT> and press :



- The selected value confirm with ,
- Using  go to <P2.2.4 STOP BITS> and press :

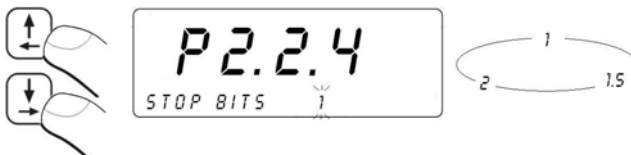

- The selected value confirm with 

Return to weighing:



See 11.3.

Caution:



Search chapter 32.2.2 of this manual to find details on connecting the scale with **EDYTOR WPW** via RS232.

14.1.4. Setting of RS 485 parameters



Procedure:

- Enter **<P2.1 RS485>** and press ,
- Using  go to **<P2.1.2 DATA BITS>** and press :



- The selected value confirm with ,
- Using  go to **<P2.1.3 PARITY BITS>** and press :



- The selected value confirm with ,
- Using  go to **<P2.1.4 STOP BITS>** and press :



- The selected value confirm with ,

Return to weighing:

See 11.3.

14.2. ETHERNET setting

ETHERNET can be configured in **<P2.4 ETHERNET>**.

Inventory of default parameters:

No	NAME	VALUE	DESCRIPTION
P2.4.1	WORK MODE	SERVER, CLIENT	Ethernet connection as Server or Client. SERVER – scale waits for connection CLIENT – scale initiates the connection to a HOST.
P2.4.2	IP ADDRESS	192.168.0.2	Setting an IP address.
P2.4.3	SUBNET MASK	255.255.255.0	Setting a subnet mask for Ethernet connection.
P2.4.4	GATEWAY	192.168.0.1	Setting a gateway for Ethernet connection.
P2.4.5	LOCAL PORT	4001	Setting a local port for Ethernet connection. Only for devices that work as SERVER. Servers waits for connection on the specified port.
P2.4.6	HOST IP	192.168.0.3	Setting a host IP address (IP of a device to connect with). Applicable only for devices configured as CLIENTs.
P2.4.7	HOST PORT	2000	Setting a Host port (a port for connection with a computer). Applicable only for devices configured as CLIENTs.
P2.4.8	TIMEOUT	60	Time (in seconds) after which none-active Ethernet connection is being broken. Set to 0 to stop breaking the connection.

Caution:

1. For appropriate setting of: **<P2.4.2 IP ADDRESS>**, **<P2.4.3 SUBNET MSK>**, **<P2.4.4 GATEWAY>** contact the supervisor of the net to connect with;
2. The way of connection via ETHERNET to the program **EDYTOR WPW** is described in chapter 32.2.3.
3. The scale does not allow the automatic fetch of net configuration from DHCP servers.

Return to weighing:
See 11.3.

15. EXTERNAL DEVICES

15.1. Cooperation with a computer

WPW scales can cooperate with computers of IBM PC class.
In submenu **<P3.1 COMPUTER>** you can configure interfaces.

WPW scales can cooperate with the **EDYTOR WPW** program. The indicator window reflects the view of a typical indicator display with all necessary pictograms. The program allows to configure a scale easily, design printout patterns, supervise databases, set parameters, collect and save printouts etc.

Caution:

1. Installation version of **EDYTOR WPW** is accessible on the Internet: **www.radwag.com**. Look up: Products / Measuring indicators / PUE C41H.
2. Check chapter 32.2 for details on cooperation with EDYTOR WPW.

15.1.1. Select the communication port scale-computer

The computer can be connected to:

- RS 232 (1)
- RS 232 (2)
- RS 485
- Ethernet

Procedure:

- Enter **<P3 DEVICES>** according to 11.2. and then:

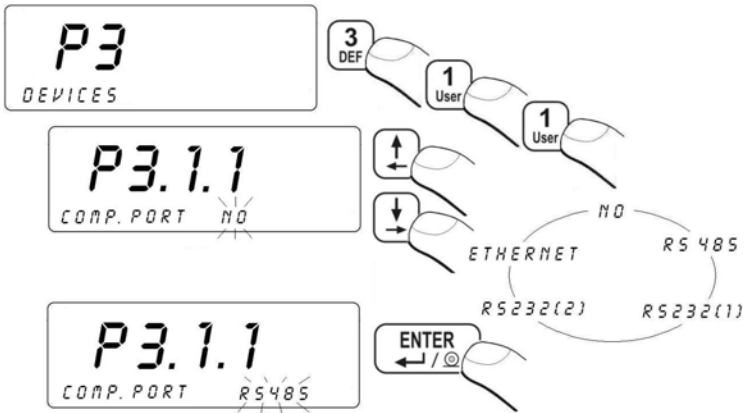

Caution:
 Standard scales can communicate with computers only via RS232(1) or RS485.

Return to weighing:
 See 11.3.

15.1.2. Type of printout scale – computer

Procedure:

- Enter <P3 DEVICES> according to 11.2. and then:

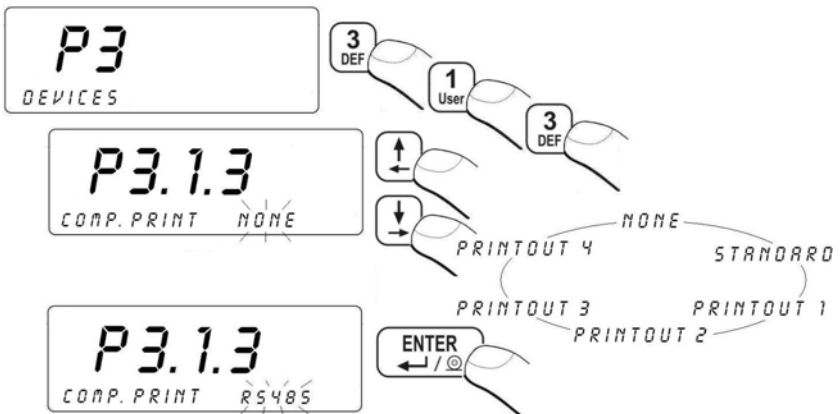

Caution:

The procedure of designing non-standard printouts is described in chapter 17.6 of this manual.

Return to weighing:

See 11.3.

15.1.3. Address setting

Procedure:

- Enter < **P3.1 COMPUTER** > according to 11.2. and then:

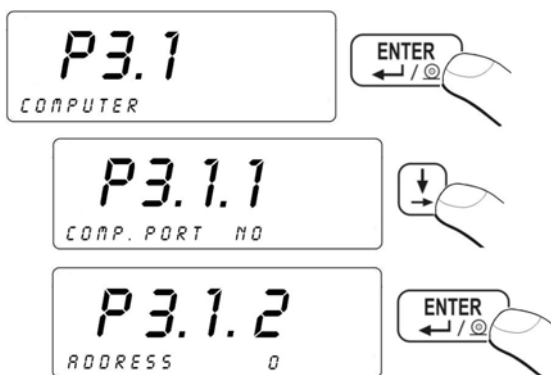

- Inscribe a value (0 to 254) and press .

Return to weighing:

See 11.3.

15.1.4. Order operating of communication protocol

User in parameter < **P3.1.4 BASIC TRS.** > has possibility to set communication protocol designed to communicate between RADWAG scale and external device.

Procedure:

- Enter < **P3.1 COMPUTER** > according to 11.2. and then:

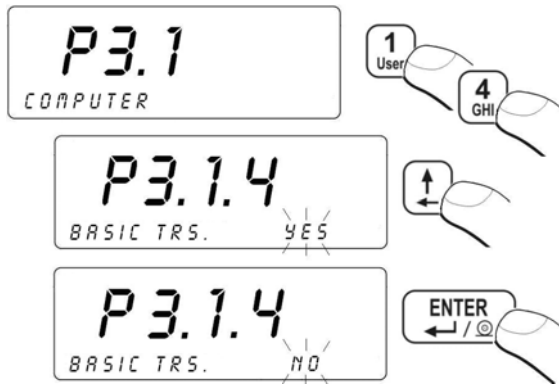

Return to weighing:

See 11.3.

15.1.5. Cooperation with „E2R System”

Scales can cooperate with computer software „**E2R System**” that is a modular system for complex production supervising by monitoring of weighings processes.

Caution:

*Enabling cooperation of the device with program „**E2R System**” can be done only by the manufacturer or authorized Service.*

15.1.5.1. Enabling „E2R System”

In order to allow the cooperation with „**E2R System**” enable parameter <**P3.1.5.1 ACTIVE SYS.**>.

Procedure:

- Enter < **P3.1 COMPUTER** > according to 11.2. and then:

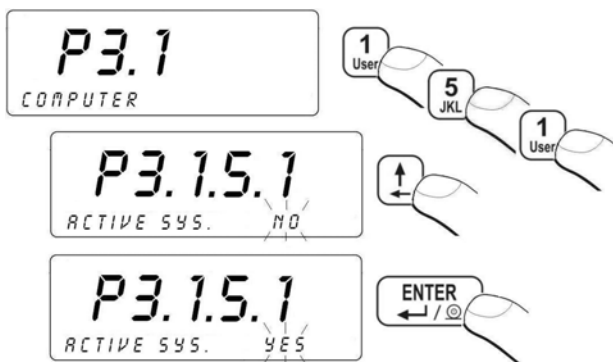

Return to weighing:
See 11.3.

15.1.5.2. Buffer for weighings

Users can declare the quantity of performed measurements to be saved in the internal buffer in the scale in case of operating **OFF-LINE** (no transmission to „E2R SYSTEM”). After reconnecting with „E2R SYSTEM” all measurements from the internal buffer will be sent to the database of the computer program.

Procedure:

- Enter < **P3.1 COMPUTER** > according to 11.2. and then:



- Type on the scale keyboard the required buffer length and confirm by pressing button .

Caution:

*The buffer equal to 0 results in saving all weighings in the database in case of operating **OFF-LINE**.*

Return to weighing:
See 11.3.

15.1.5.3. The lock of product change

Users can lock changing products by scale operators cooperating with „E2R SYSTEM”.

Procedure:

- Enter < **P3.1 COMPUTER** > according to 11.2. and then:

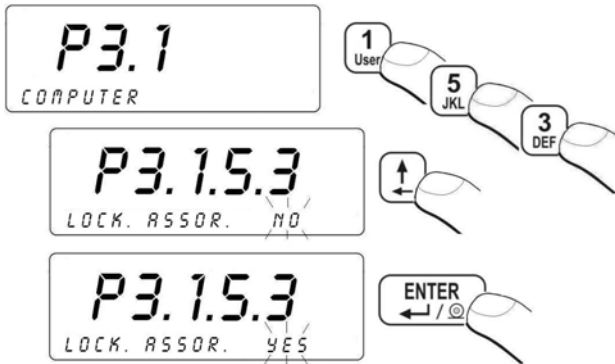

Return to weighing:
See 11.3.

15.2. Cooperation with printers

Press  to send the current measurement together with the weighing unit to a printer.

15.2.1. Communication port scale - printer

Following ports can be used:

- RS 232 (1),
- RS 232 (2),
- RS 485,
- Ethernet.

Procedure:

- Enter **<P3.2 PRINTER>** and then:

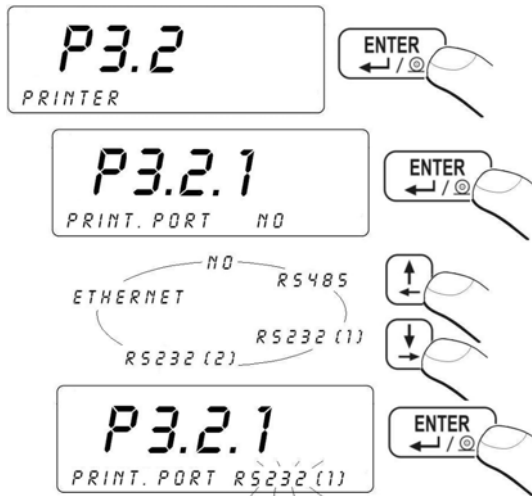

Return to weighing:

See 11.3.

15.3. Cooperation with a barcode scanner

The scale gives possibility to cooperate with barcode scanners. It is used for quick search of database of assortment.

Caution:

*In **<P2 COM PORTS PARAMETERS>** set the baud rate for the same as your barcode scanner requires (default 9600b/s). See details for cooperation with barcode scanners in chapter 32.1 of this manual.*

15.3.1. Select a communication port for the scanner

Procedure:

- Enter **<P3.3 BARCODE SCANNER>** and then select a communication port with the barcode scanner:

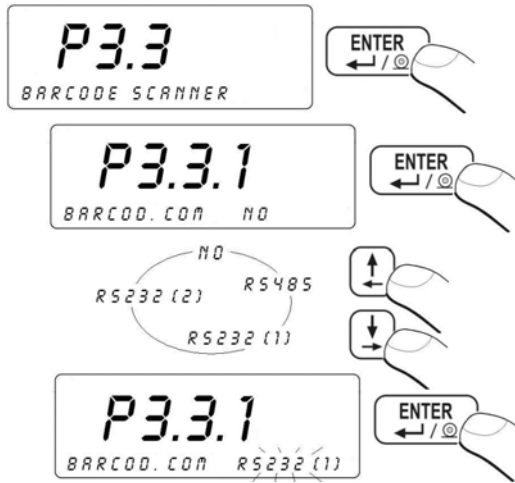

Return to weighing:
See 11.3.

15.3.2. Setting the START parameter

Procedure:

- Enter **<P3.3 BARCODE SCANNER>** and then set the **START** parameter – a character number in barcodes that is to be analysed during the assortment database search:

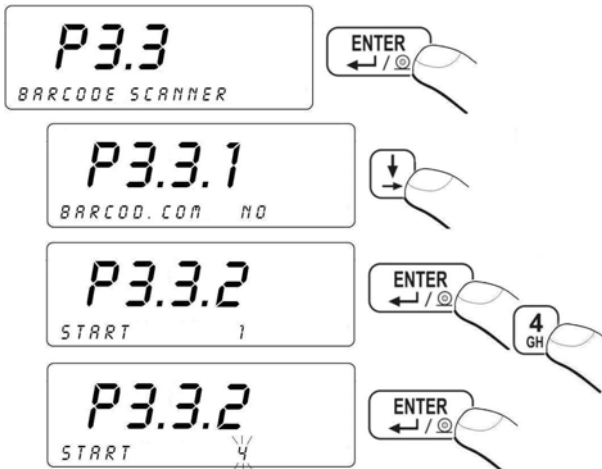

Return to weighing:
See 11.3.

15.3.3. Setting the LENGTH parameter

Procedure:

- Enter **<P3.3 BARCODE SCANNER>** and then set the **LENGTH** parameter – the number of character in barcodes (counting from **START**) that is to be analysed during the assortment database search:

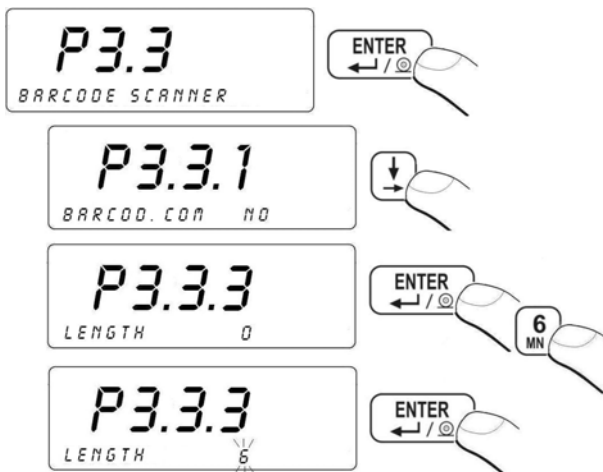

Return to weighing:
See 11.3.

15.4. Cooperation with a transponder card reader

Operators can be logged in after powering up the device or previous logging out by:

- Inscribing a password using the scale keyboard,
- Using transponder cards to log in.

Caution:

In parameters <P2 COM PORTS PARAMETERS> set the baud rate for the one that requires the barcode scanner (default 9600b/s).

15.4.1. Selecting of communication port

In parameters <P3.4 TRANSP. CARD READER.> and then select a communication port with the transponder card reader:

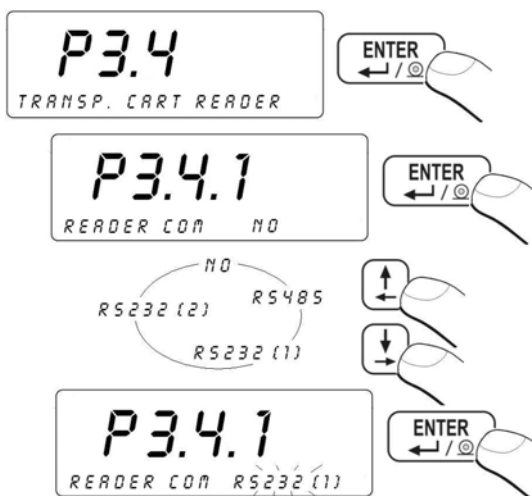

Return to weighing

See 11.3.

15.4.2. Procedure of ascribing card numbers to operators

In order to log in using a transponder card you need to have it previously ascribed to a specific operator.

Procedure:

- Connect a transponder card reader to RS232/RS485 on the back wall of the terminal,
- Select a communication port (see 15.4.1),

- In parameters **<P2 COM PORTS PARAMETERS>** set the baud rate (default 9600b/s).
- Enter the database of operators and then find and edit the required operator. Find **<CARD CODE>** field:

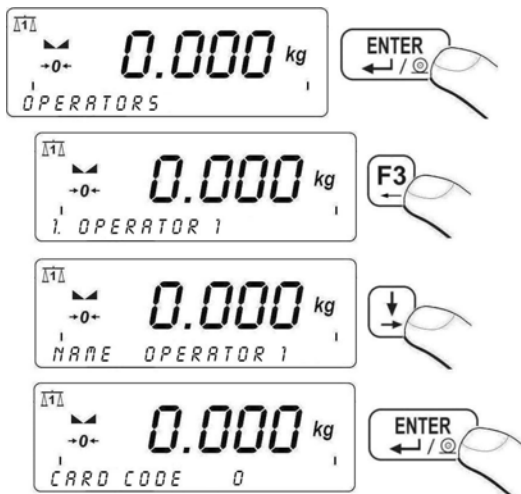

- Approaching a card to the reader results in displaying the card number in the **<CARD CODE>** field,
- Press  to confirm,
- Return to weighing – chapter 11.3.

15.5. Cooperation with an additional display

15.5.1. Selecting a communication port

Additional displays can be connected to:

- RS 232 (1)
- RS 232 (2)
- RS 485

Procedure:

- Enter **< P3.5 ADDITIONAL DISPLAY >** according to 11.2. and then:

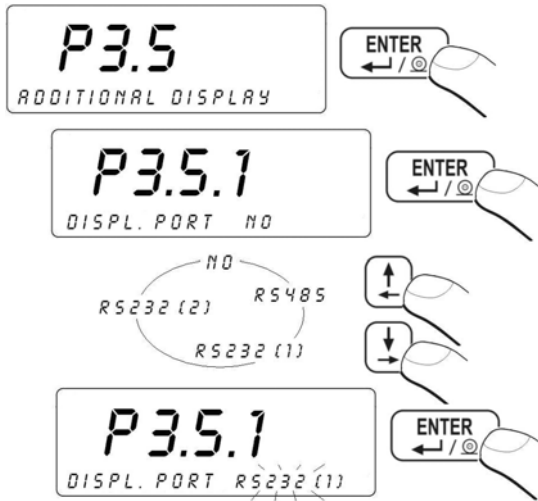

Return to weighing:
See 11.3.

15.5.2. Selecting an additional display type

Procedure:

- Enter < P3.5 ADDITIONAL DISPLAY > according to 11.2. and then:

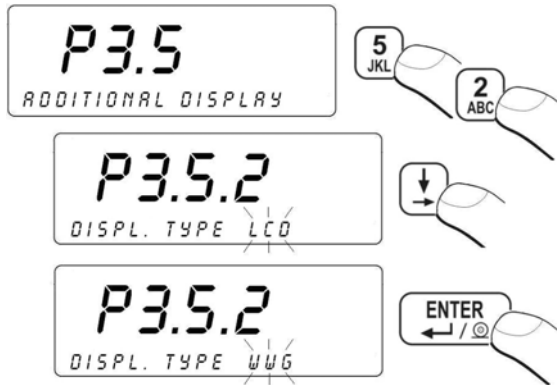

Return to weighing:
See 11.3.

16. DATE / TIME SETTING

Enter <P4 DATE / TIME> to set these parameters.

16.1. Time view

Procedure:

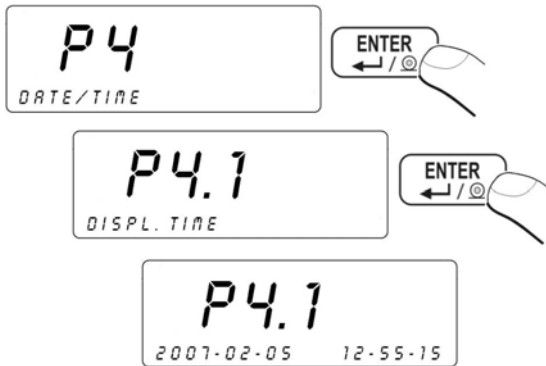

Return to weighing:

See 11.3.

16.2. Time setting

Procedure

- Enter the **DATE / TIME**> and then:

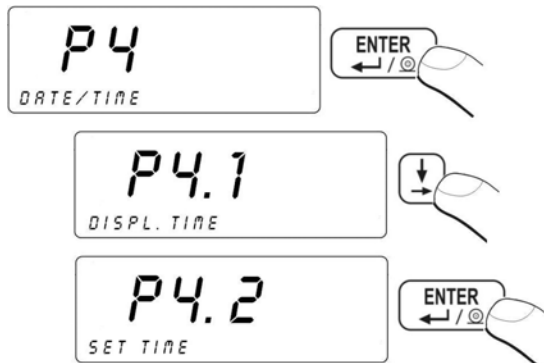

- After pressing  you will see:



- Enter an appropriate value and confirm it with .
- You will have to enter the following variables in sequence:

- MONTH
- DAY
- HOUR
- MINUTE

- After confirming the last value with  you will see the current date and time:

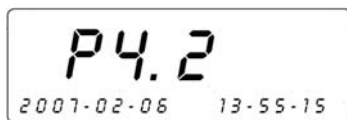

Return to weighing:

See 11.3.

16.3. Date format

Date can be displayed in different format.

Procedure:

- Enter **<P4 DATA / TIME>** and proceed as follows:

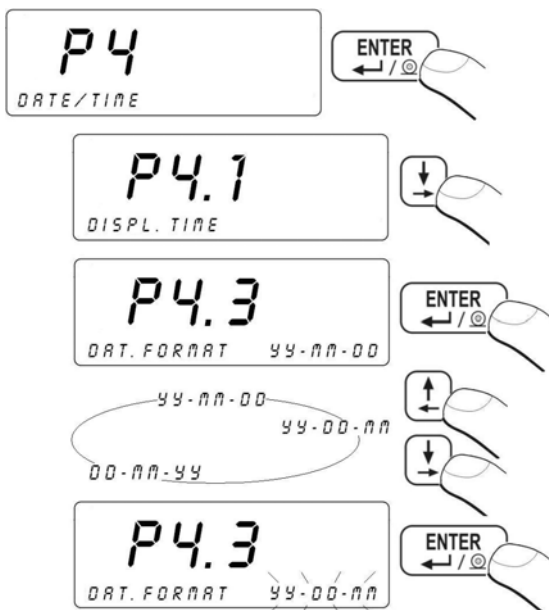

- YY - MM - DD** - year - month - day
- YY - DD - MM** - year - day - month
- DD - MM - YY** - day - month - year

Return to weighing:
See 11.3.

17. PRINTOUTS

17.1. Printout type

Setting the **<P5.1 AUTO. PRINT>** parameter can set a type of printout:

Procedure:

- Enter **<P5 PRINTOUTS>** according to 11.2. and then:

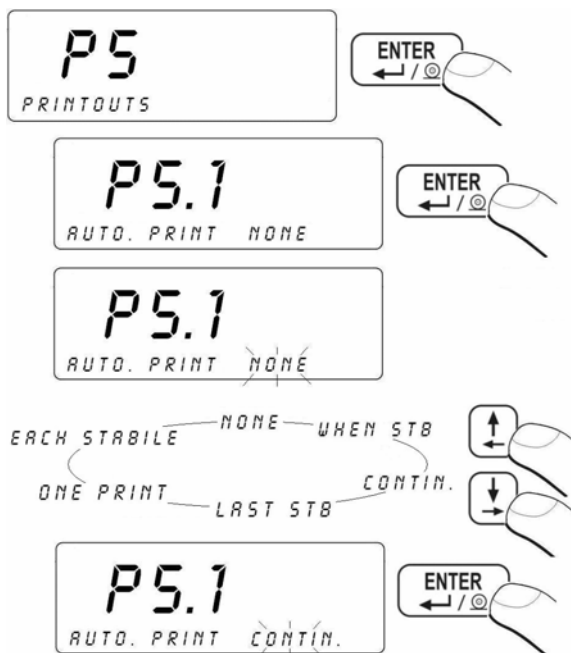

- | | |
|--------------------|--|
| NO | - manual printout |
| WHEN STB | - automatic printout after stabilising |
| CONTIN. | - continuous printouts |
| LAST STB | - printing the last stable result after taking of a load, before reaching the LO- value |
| ONE PRINT | - Single print over -LO- |
| EACH STABLE | - Automatic printout of each stable measurement over the -LO- |

Return to weighing:
See 11.3.

17.2. Printout of stable / unstable data

Enter **<P5.2 STAB. PRINT>**, to set the printout as:

- Stable data,
- Immediate data.

Procedure:

- Enter **<P5 PRINTOUTS>** according to 11.2. and then:

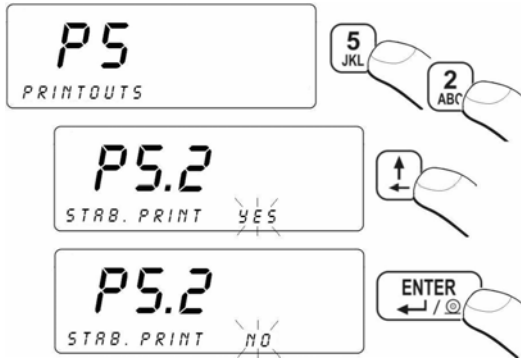

Return to weighing:

See 11.3.

Notice:

*In case of verified scales **<P5.2 STAB. PRINT>** is not accessible for users.*

17.3. Checkweighing mode

In this mode printout is possible only when the result is between **Min, Max** thresholds.

Procedure:

- Enter **<P5 PRINTOUTS>** according to 11.2. and then:

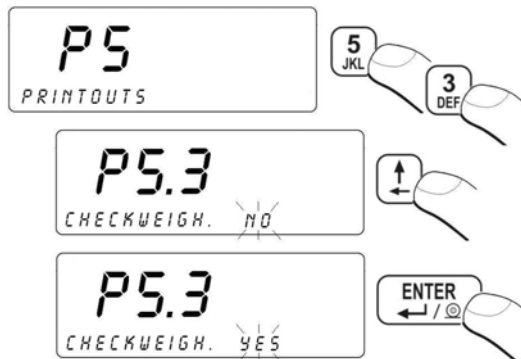

Return to weighing:
See 11.3.

17.4. Non-standard printouts

Users have possibility to design non-standard printouts in **<P5.4 PRINTOUT>**.

Procedure:

- Enter **<P5 PRINTOUTS>** according to 11.2. and then:

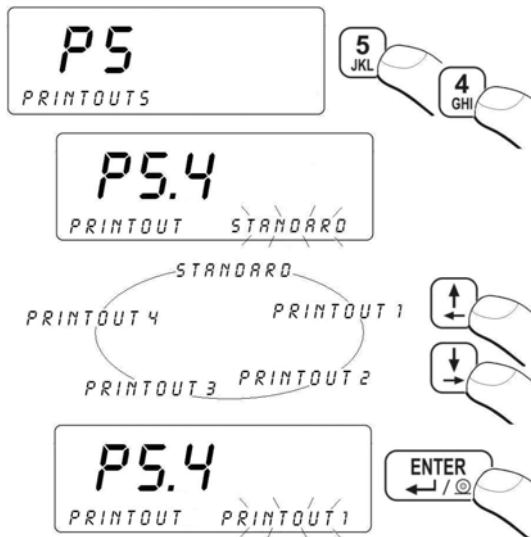



Return to weighing:
See 11.3.

17.5. Designing non-standard printouts

To create a non-standard printout:

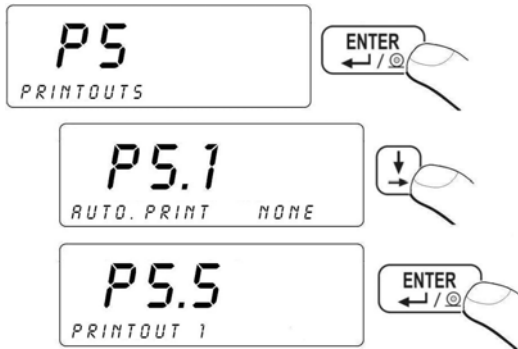
- Enter **<P5 PRINTOUTS>** according to 11.2. and then:



- After pressing , you will see a cursor. Software is ready to accept your data.

Non-standard printout can comprise:

- Constant texts,
- Variables from different work modes (mass, date, thresholds etc.),
- Non-standard printout design can include max. 320 characters,
- Non-standard printout sent to a printer can include max. 640 characters,
- Up to 4 non-standard printouts can be designed.

Caution:

1. During designing non-standard printouts all special characters like CRLF, tabulators etc. have to be added.
2. Examples of designing non-standard printouts can be found in chapter 32.4.

17.6. Texts in non-standard printouts

17.6.1. Code format

- % **XXX** - sending to a printer a variable **XXX** value
- * **XXX YY** - sending to a printer **YY** (declared) characters of **XXX** variable value justified to the left.

Caution:

Every non-standard printout should be terminated with **␣** character

17.6.2. Variables appearing in all modes

CODE	DESCRIPTION
%000	Mass in a basic unit of the active platform
%001	Mass in a current unit of the active platform
%002	Date
%003	Time
%004	Date and time
%005	Calibration unit
%006	Current unit
%007	Min threshold (for checkweighing)
%008	Max threshold (for checkweighing)
%009	Min threshold (for checkweighing) 7 digits
%010	Max threshold (for checkweighing) 7 digits
%011	Net mass in the calibration unit
%012	Gross mass in the calibration unit
%013	Display result in a present unit
%014	Tare in calibration unit
%015	Statistics – ordinal number
%016	Statistics – sum in the calibration unit
%017	Statistics – average value in the calibration unit
%018	Statistics – minimal value in the calibration unit
%019	Statistics – maximal value in the calibration unit
%020	Statistics – unit
%021	Single pcs mass
%022	Standard (nominal) mass in Checkweighing
%023	Platform number
%024	Operator name
%025	Operator code
%038	Article name (assortment)
%039	Article code (assortment)
%040	Article EAN code (assortment)
%042	Minimal mass of article (assortment)
%043	Maximal mass of article (assortment)
%044	Article tare value (assortment)
%056	Net mass (lb)
%058	Number of digits after the point (calibration unit)
%059	Number of digits after the point (current unit)
%060	Net mass in EAN 13 (6-character code)
%061	Net mass in EAN 13 (7-character code)
%064	Net mass in EAN 128

%067	Net mass (lb) in EAN 128
%068	Gross mass EAN 128
%070	Date in EAN 128
%126	Reference quantity for counting pieces
%127	Difference of tare values (a product tare value subtracted from present tare value)
%128	Batch number (6 characters)
%131	Dosing net mass in calibration unit
%132	Present number of records in the weighing database
%134	Batch number (10 characters)
%136	Present correction for dosing in calibration unit
%137	Present corrected MAX threshold for dosing
%138	Loss in weight in per cents
%139	Net mass in calibration unit decreased by loss in weight
%140	Net mass in present unit decreased by loss in weight

17.6.3. Variables for printing out weighings from the database

%073	Weighing net mass
%075	Weight unit
%076	Weighing date
%077	Weighing time
%078	Operator code
%079	Assortment code
%080	Contractor code
%083	Number of series
%084	Platform number
%135	Batch number

This program includes a standard pattern of printouts from the database (pattern name: ***WG01***), with following variables:

- Net mass of weighing,
- Date,
- Time.

Caution:

*Remember that the name of a new printout design should have the following pattern: ***WGXX***, where: **XX** – subsequent number of printout.*

17.6.4. Variables for printouts of reports from weighings

%086	Weighing status (threshold for weighing - MIN, OK or MAX)
%087	Sum of weighings
%088	Weight unit
%089	Number of weighings
%090	Start date
%091	End date
%092	Operator code
%093	Assortment code
%096	Batch number printout
%097	Series number
%098	Type of weighings (% , pcs, kg etc.)
%099	Platform number
%129*	Present record name for generating a complex report
%130*	Marking of the space for weighings in a complex report (the variable needs to be situated at the beginning and in the end of the requested printing space)

*) – Variables for complex report pattern (i.e. with heading and footer).
An example of complex report is described in ch.32.5 of this manual.

The program includes 4 patterns of reports from weighings. ***RP02*** is the English equivalent of ***RP01*** and ***RP04*** is an English equivalent of ***RP03***:

Name	Comprised variables
RP01	Sum of weighings Number of weighings Start date End date
RP03	Operator code Assortment code Contractor code Sum of weighings Number of weighings Start date End date

Caution:

1. Remember that the name of a new printout design should have the following pattern: ***RPXX***, where: **XX** – subsequent number of printout.

2. Standard software do not include a database of contractors. That is why the printout ***RP03*** substitutes „Contractor code” with dashes <----->.

17.6.5. Special characters that can be used in non-standard printouts

\\	Single character - „\”
\c	CRLF
\r	CR
\n	LF
\t	Tabulator
\0	End of printout

Every text in a non-standard printout may include up to 320 characters (letters, digits, special characters, spaces).

Example:

```
„RADWAG”
  Date:
  Time:
  Mass:
  Signature:.....
```

The inscribed data for:

```
“RADWAG”\C\TDATE:%002\C\TTIME:%003\C\T
MASS:%000\C\C\T\TSIGNATURE:.....\C\0
```

18. DATABASES

18.1. Logging in

In case of activating of logging procedure (submenu <**P6.1 LOG IN**>), an operator after switching on has to perform a jogging procedure which consists in inscribing a password.

Operators can also use a transponder cards for this procedure provided the terminal is equipped in a transponder card reader (see 15.4).

Procedure:

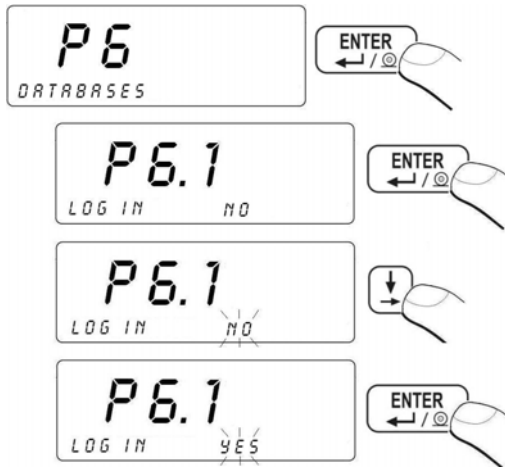

- Enter **<P6 DATABASES>** according to 11.2. and then:



Return to weighing:

See 11.3.

Users can log in even if this procedure is disabled at the start:

- Turn on the device ,
- Press  during a display test,
- Program will show the following window:

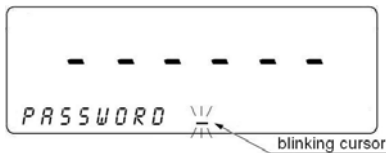

Notice:

In case there are no data in the operators' database press  to skip the logging procedure and add at least one operator with the highest level access. If no ADMINISTRATORS are defined there will be no access to some functions designated only for administrators.

18.2. Access level

18.2.1. Access level to edition of databases

Any administrator is able to set one of three levels of edition of databases: administrator, advanced operator or operator.

Procedure:

- Enter <P6 DATABASES> according to 11.2. and then:

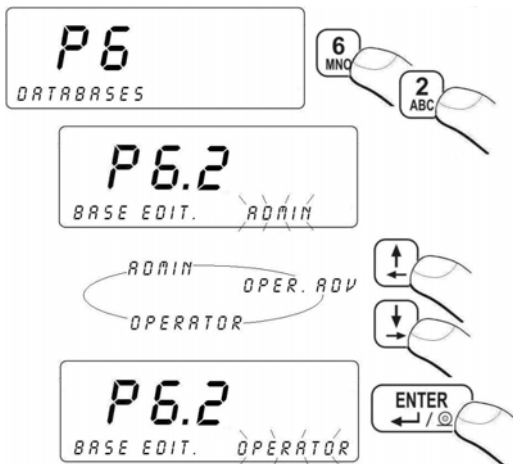

Return to weighing:

See 11.3.

Notice:

This setting is valid although the standard logging is disabled.

18.2.2. Access level for disabled logging

The scale program gives possibility to set an access level in case of disabling logging procedure.

Procedure:

- Enter <P6 DATABASES> according to 11.2. and then:

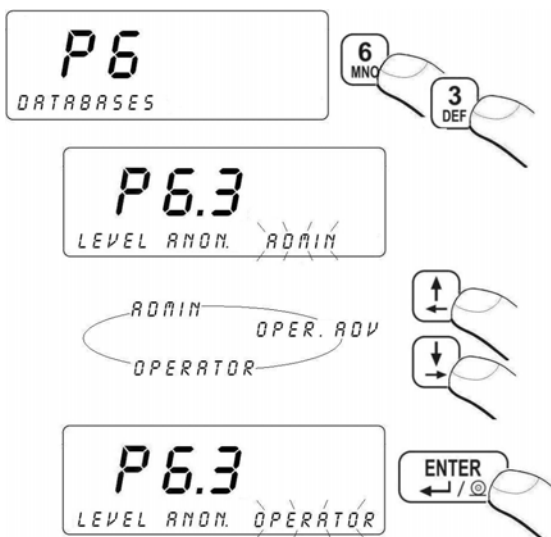

- OPERATOR**
- Can perform weighings, edit P1, P4, P9 parameters; cannot edit databases and erase statistics; cannot change weighing thresholds Min, Max, cannot adjust the standard mass in modes “counting pieces” and “deviations”.
- ADVANCED OP.**
- Can perform weighings and edit parameters except P8, P10 and P6.1, P6.2, P6.3; can edit databases except operators;
- ADMIN**
- Have a full access to parameters and databases, can perform user calibration (in non-verified scales).

Return to weighing:
See 11.3.

18.3. Password type

It is possible to set the password type to inscribe.

Procedure:

- Enter **<P6 DATABASE>** according to 11.2. and then:

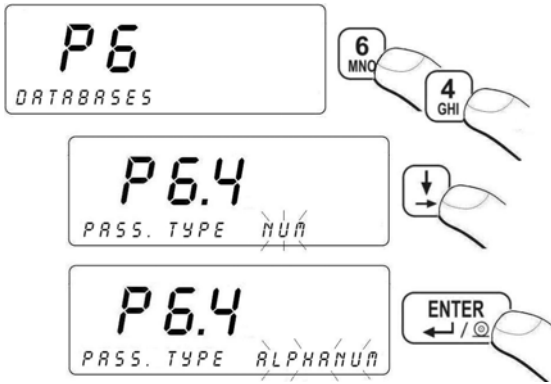

- NUM** - only digits **0** to **9**
- ALPHANUM** - alphanumeric password

Return to weighing:
See 11.3.

18.4. Type of codes

There is possible to select a type of codes. You can set this in database settings.

Procedure:

- Enter **<P6 DATABASES>** according to 11.2. and then:

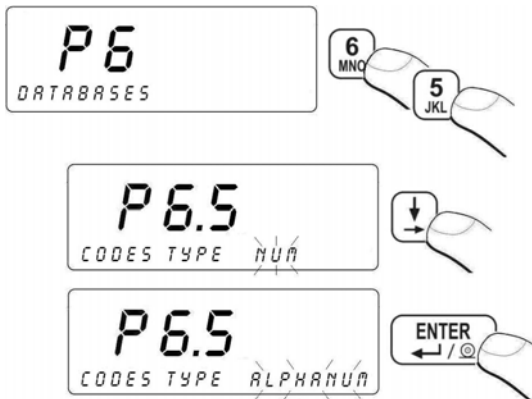

- NUM** - only digits **0** to **9**
- ALPHANUM** - alphanumeric password

Return to weighing:
See 11.3.

18.5. Access to edition of databases

Procedure:

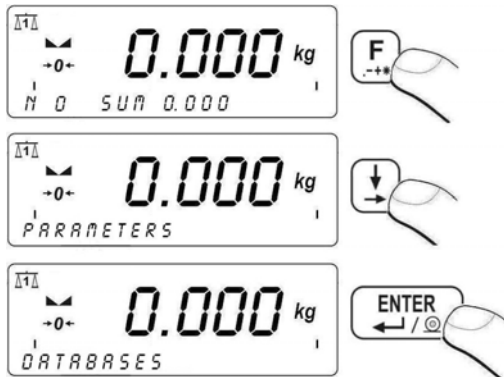

Return to weighing:
See 11.3.

Caution:

Users can access different things in the menu according to their Access levels. It also concerns an access to databases.

18.6. Quick searching in databases

Users can search databases using different criteria:

- Code,
- Name,
- Record number.

This procedure is applicable for operators and assortment.

18.6.1. Quick code search

Procedure:

- While in any work mode press **F1** (select / view products in the assortment database) and then:

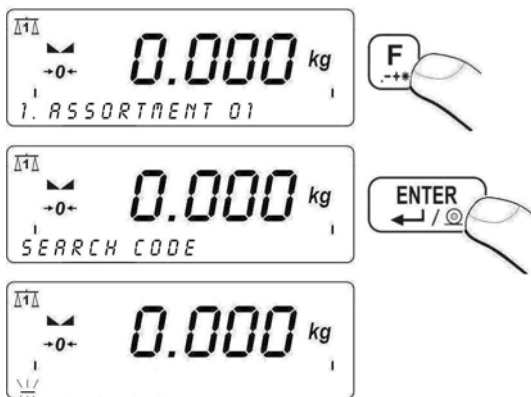

- Inscribe the product code you search and then press **ENTER**.
- The program displays the product you search in the bottom line.

Caution:

If the search result is not successful the **<NO RECORD>** message in the bottom line is displayed for 1 second and then software returns to displaying the current record.

Return to weighing:

See 11.3.

18.6.2. Quick name search

Procedure:

- While in any work mode press **F1** (select / view products in the assortment database) and then:

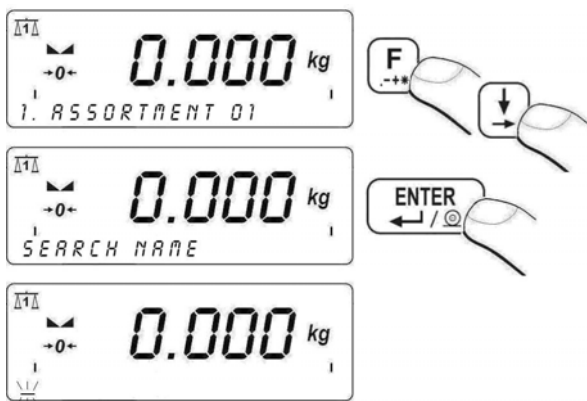

- Inscribe the product name you search and then press .
- The program displays the record you search in the bottom line.

Caution:



You can inscribe a part of the product name to start searching. The program will display the first string it encounters with the same beginning as the inscribed one. If the search result is not successful the <NO RECORD> message in the bottom line is displayed for 1 second and then software returns to displaying the current record.

18.6.3. Quick number search

Procedure:

- While in any work mode press  (select / view products in the assortment database),
- Scale program displays the record number one in the bottom line:



- Using numeric keys  to  enter a required record number,
- Scale program displays the record in the bottom line:

Return to weighing:

See 11.3.

18.7. User database

The database of operators can hold up to 100 records in standard setting of databases.

Procedure:

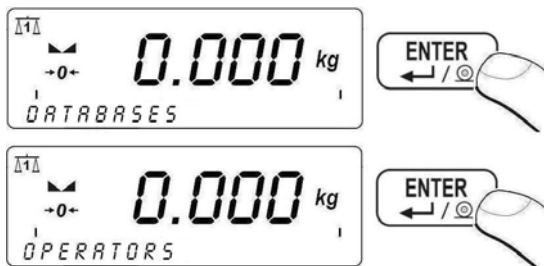

- Enter databases according to 18.5. and then:



- When the database is empty you will see:



- Press **F1** to add an operator,
- In the bottom line you will see the first line for inscribing data.
- You can enter the edition end confirm any data by pressing **ENTER**.

You can select fields using  .

Fields in an operator record:

NAME	Operator name (max. 40 characters)
CODE	Operator code (max. 6 characters)
PASSWORD	Password for logging (max. 8 characters)
CARD CODE	Transponder card code (max. 15 digits)
AUTHORIS.	Access level

- After defining all fields in a record of operator press **ESC**,
- Then you will see:



- Press **ENTER** if you want to save,
- You will see an operator name and a position in the database:



- To delete an operator press **F2** (DEL),
- To edit a defined operator press **F3** (←),
- To delete all records press **F4** (CLEAR).

Return to weighing:

See 11.3.

18.8. Assortment database

The assortment database can comprise up to 3000 records.

Procedure:

- Enter databases according to 18.5 of this manual:

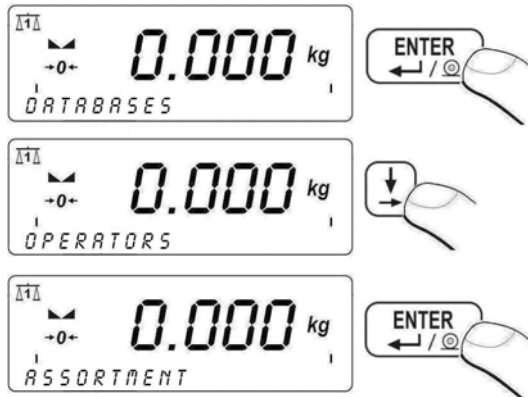

- In case the database is empty you will see:



- Press **F1** RESET to add a record,
- You will see the first empty record in editing mode.
- Entering edition and confirming changes can be made by pressing **ENTER** ←/⊙. Select fields to be changed using **↓** **↑** keys.

Fields in the assortment database:



NAME	Product name (max. 40 characters)
CODE	Product code (max. 7 characters)
EAN	Constant code that can be used as a barcode (max. 15 digits)
MIN	Minimal mass for checkweighing
MAX	Maximal mass for checkweighing
TARE	Tare value (it is preset automatically after selecting a product)
STR CORRECTION	The mass value that is added to or subtracted from the nominal mass in dosing
DOSE. OUTPUT NO.	Declaration of output number for precise dosing of a product
FAST DOSE. OUTPUT NO.	Declaration of output number for fast dosing of a product

- After defining all fields press ,
- You will see the following inscription:



- Press  to save changes,
- You will see the products name you have edited:



- To erase the selected record press ,
- To edit the selected record press ,
- To clear the database press .

Return to weighing:

See 11.3.

18.9. Weighings database

Every result sent from the scale to a printer is also saved in the database of weighings. There is possible to save up to 30 000 records in database in standard setting.

Procedure:

- Enter the database according to 18.5 and then:

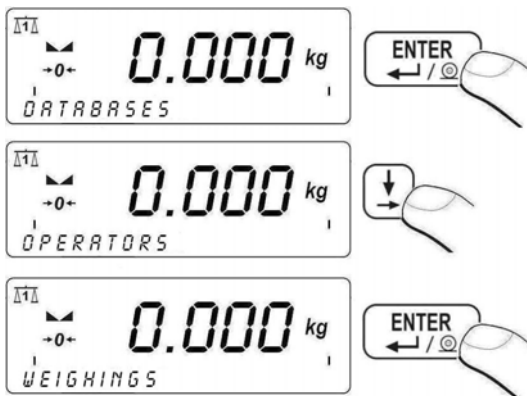

- When the database is empty you will see:



- In case when the database is not empty, you will see the first record (date, mass, unit):

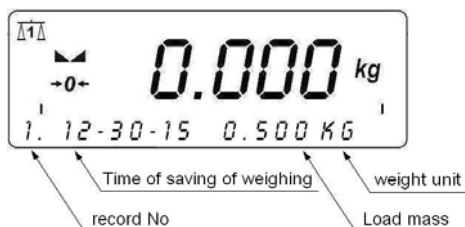

- To delete the selected record press **F2 DEL**,

- To delete all records press **F4** (CLEAR).
- To print the selected record press **ENTER** (↵/Ⓞ).

Notice:

1. Single record can be deleted only when first in the database (the oldest record).
2. The printout pattern and variables for designing non-standard printouts are described in ch. 17.6 of his manual.

Return to weighing:

See 11.3.

18.10.Database of tare values





It is possible to hold up to 100 tare values (for every platform).

Procedure:

- Press **↵** twice in any work mode,
- In case when there is no record you will see the following window:



- To enter a tare value **F3** (←),
- Using numerical keys **0** (0) to **9** (WXYZ) inscribe a value and confirm with **ENTER** (↵/Ⓞ),
- Press **ENTER** (↵/Ⓞ) one more time to return to the weighing mode. You will see the entered value with „-“.
- To delete a selected tare press **F2** (DEL),
- To edit a selected tare press **F3** (←),
- To delete all tare press **F4** (CLEAR),

- You can browse the database using   or by inscribing a position number using  to .

Caution:

If users confirm a tare value greater than the maximal value (full scale) you will see the following inscription: **<TOO HIGH VALUE>**.

Return to weighing:

See 11.3.

18.11. General purpose variables







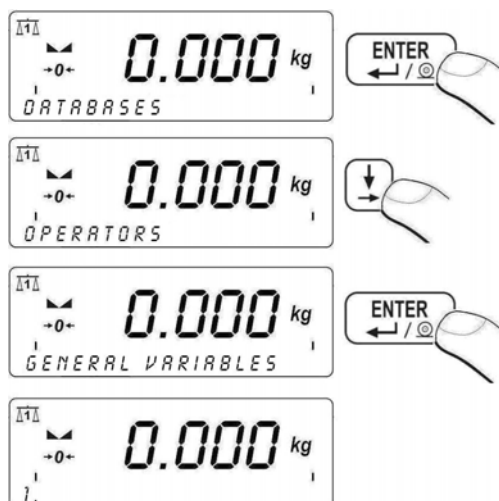

You can inscribe any text to be memorized for printouts. You can view or edit them from the level of databases in the menu or using a quick access method by pressing  from any work mode (apart from dosing).

18.11.1. Editing general purpose variables

Procedure:

- Enter databases according to 18.5 and then:



- To add or modify a record (inscribing characters like in mobile phones) press ,
- To add or modify a record (inscribing only digits **0** to **9**) press ,
- To clear a field press  when you are in,
- Using appropriate keys inscribe a variable and confirm it by pressing ,
- You can browse the variables using   or by inscribing a variable position number  to  to get a quick access.

Return to weighing:

See 11.3.

18.11.2. General purpose variables in printouts

The database of general purpose variables can comprise up to 100 records. Each record can hold up to 40 characters. Each variable has prescribed a code number formatted as **% XXX** or *** XXX YY**:

% XXX - inserting to the printer buffer a dedicated variable, where:

XXX – is between 801 to 900, which is equivalent to subsequent records in the database (e.g. code 802 is equivalent to the 2nd position in the database).

*** XXX YY** - inserting to the printer buffer a dedicated variable, where **YY** is a declared quantity of characters from a variable **XXX**.

Example:

„RADWAG”

Date:

Time:

Mass:

signature:.....

Where: < „RADWAG”> is a universal variable No 3. After entering non-standard printouts (see 17.5) we design a printout:

```
% 8 0 3 \ C \ T D A T E : % 0 0 2 \ C \ T T I M E : % 0 0 3 \ C \ T M  
A S S : % 0 0 0 \ C \ C \ T \ T S I G N A T U R E : . . . . . \ C \ 0
```

19. REPORTS FROM WEIGHINGS

Users can print reports from weighings.

Reports can be filtered according to:

- start date,
- end date,
- operator code,
- assortment code,
- type of weighing,
- weighing platform number,
- number of series,
- batch number.

19.1. Editing reports

While in any work mode press  and then:

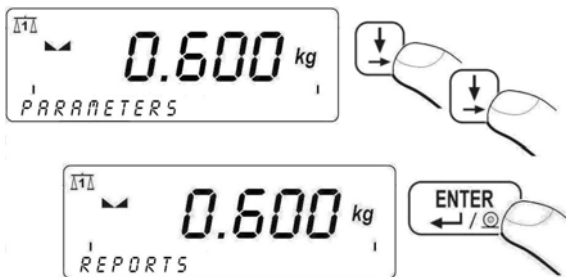



Return to weighing:
See 11.3.

19.2. Printouts of reports

After entering (see ch. 19.1) you will see the following display:





- To edit variables press ,
- Confirm changes by pressing ,
- To filter according to the selected variable press , and you will see the following window:





- Press  to go to the next variable,

Caution:



Code filter of assortment or operator can have following values:

- ALL (key ) – complex report comprising weighings for each product or operator separately,
- NON-ZERO (key ) - complex report comprising weighings for each product or operator separately.

An example of complex report pattern is described in ch. 32.5 of this manual.

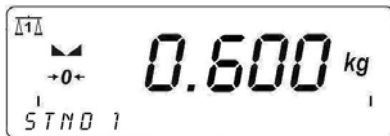
- After editing all variables go to the next item **<PRINT REPORT>** by pressing .
- Press , you will see the window:



- Using   select one of four patterns (details in ch.17.6),
- Press  to print out the report.

Return to weighing:

See 11.3.

Caution:

If a user disables filtering according all the variables, the program will print out a report from all the weighings.



20. CONFIGURATION OF EXTERNAL INPUTS / OUTPUTS

20.1. Configuration of external buttons



Following external buttons can be connected:

TARE BUTT	Tare button
PRINT BUTT	Print button
ZERO BUTT	Zero button
START BUTT	Start button, Start weighing animals button
STOP BUTT	Button for breaking dosing process, Button for breaking weighing animals
EXT. START	Input signal allowing to START dosing
TERM. BUTT.	Terminating of dosing process
CHUTE PERM.	Perdition input signal for chute

Procedure:

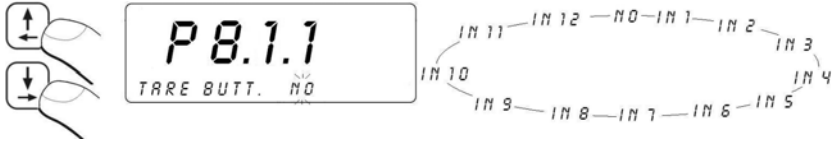
- To declare a number of input ascribed to the button enter **<P8.1 EXTERNAL BUTTONS>** and then,
- Press , you will see **<P8.1.1 TARE B.>**,
- Press :



- Confirm your selection with ,
- Using  go to the next parameter.

Caution:

You can ascribe all your buttons accordingly. Remember that the standard solution has only 3 inputs.

Return to weighing:

See 11.3.



20.2. Configuration of outputs

Users can configure outputs according to their needs.



You can declare outputs:

MIN	Mass below the Min threshold
OK	Mass between Min and Max threshold
MAX	Mass over the Max threshold
STABLE	Stable result over the LO threshold
THRESH 1	Threshold of passing from dosing to precise dosing in dosing mode
THRESH 2	Completing dosing process
CHUTE	Chute control

Procedure:

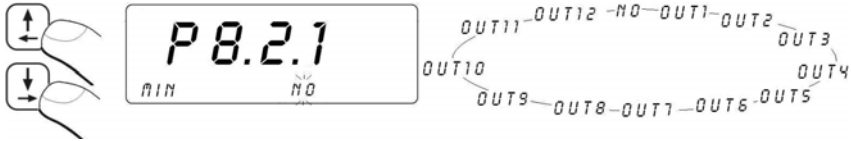
- To declare an output number connected with the function, enter **<P8.2 OUTPUT CONF.>** and then:
- Press , you will see **<P8.2.1 MIN>**,
- Press :



- Confirm the selected value with ,
- Using  go to the next function.

Notice:

You can ascribe all functions to outputs accordingly. Remember that the standard solution has only 3 reed relay outputs.

Return to weighing:

See 11.3.

21. STATISTICS

21.1. Updating statistics

All statistics are updated in real time after every subsequent measurement after putting a load on the pan, reaching equilibrium, and pressing . Number of weighings and sum are shown in the lower line of the display.



Statistics can be calculated globally (does not depend on the selected product) or separately for every product from the assortment database. It can be set in parameters **<P6.6 STATISTICS>**.

Procedure:

- Enter < **P6 DATABASES** > according to 11.2. and then:

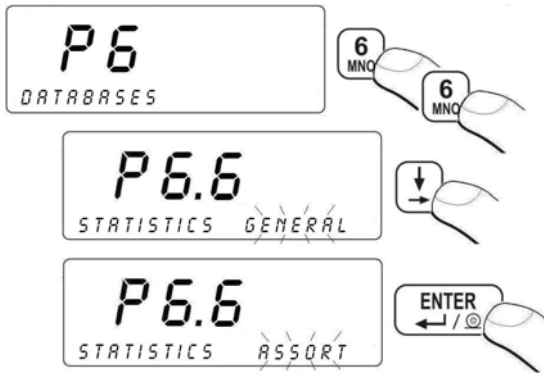

- GENERAL** - global statistics,
- ASSORT** - statistics for every product.



Return to weighing:
See 11.3.

21.2. Printouts of statistics

Users can print out statistics in any work mode.

Procedure:



Using   users can view the current statistics: **SUM** – total mass of all details, **AVG** – every mass of all details, **MIN** – minimal mass, **MAX** - maximal mass.

Printout example:

- | | |
|-----------------------|-----------------------------|
| N = 7 | - number of weighing |
| SUM = 3.800 kg | - total mass |
| AVG = 0.543 kg | - average mass of all loads |
| MIN = 0.200 kg | - minimal mass |
| MAX = 1.000 kg | - maximal mass |

21.3. Zeroing statistics

Users can delete statistics to start a new series of measurements.

Procedure:

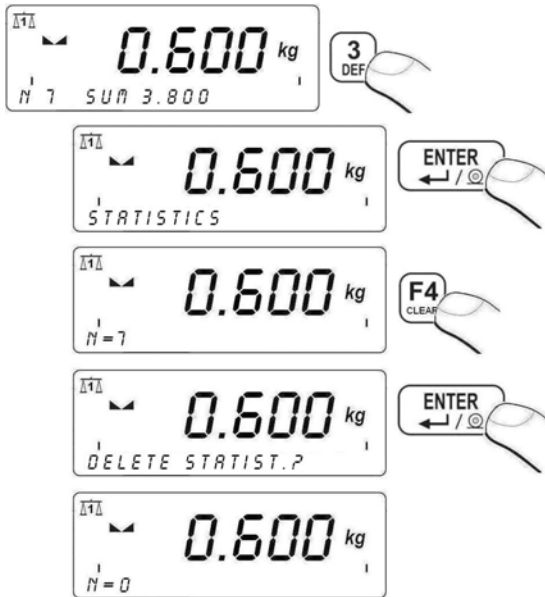

Return to weighing:
See 11.3.

Caution:

1. When a user changes a work mode all statistics are automatically deleted.
2. Statistic data are common from all platforms connected (no separate calculations).

22. OTHER PARAMETERS

Users can set parameters that influence the weighings procedure. There are included in <P9 OTHER> e.g. language, backlight, BEEP sound.

22.1. Language setting

Procedure:

- Enter <P9 OTHER> according to 11.2. and then:

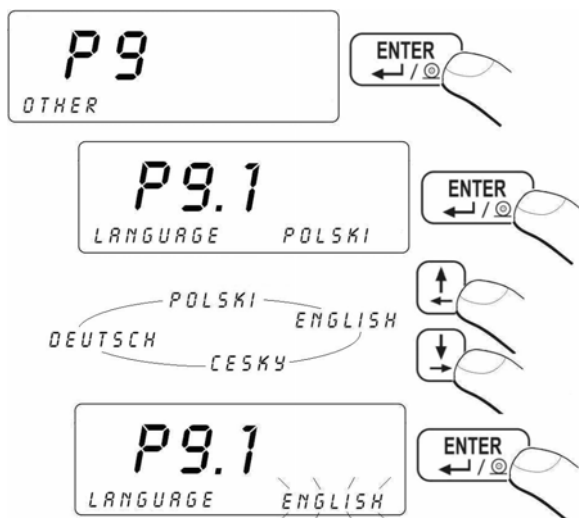

Return to weighing:

See 11.3.

22.2. LED power setting

According to the requirements (e.g. intensity of external light) it is possible to change the light flux from LEDs in the scale of 0% to 100%.

Procedure:

- Enter <P9.2 DIODES> according to 11.2. and then:

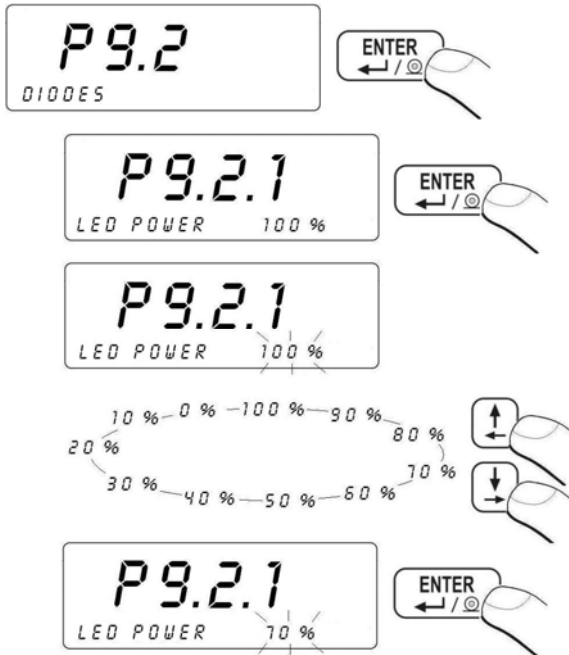

Return to weighing:

See 11.3.

22.3. Work modes for LEDs

In <P9.2 DIODES> users can chose a work mode for LEDs.

Procedure:

- Enter <P9.2 DIODES> according to 11.2. and then:

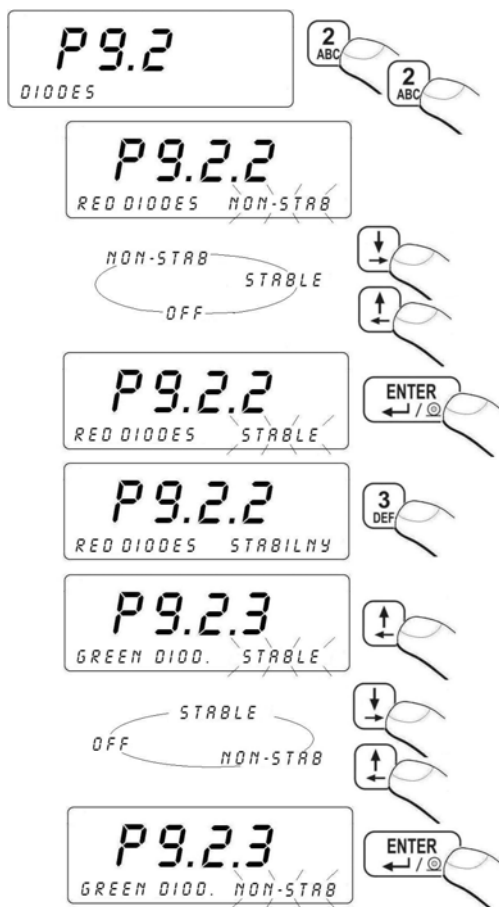

RED LEDS NONSTAB.

diodes start to lit after exceeding the LO threshold (see 13.3),

RED LEDS STABLE

diodes start to lit after exceeding the LO and reaching equilibrium,

RED LEDS OFF

diodes not work,

GREEN LEDS NONSTAB.

diodes start to lit after exceeding the LO,

GREEN LEDS STABLE

diodes start to lit after exceeding the LO and reaching equilibrium,

GREEN LEDS OFF

diodes not work.

Return to weighing:

See 11.3

22.4. Automatic power down

Changes can be made in **<P9.3 POWER SAVE>**. When the **POWER SAVE** function is enabled the device switches off after 5 min. Provided no changes on the pan appeared (no changes on the display).

Function setting	Operation	
	Mains	Accumulator
POWER SAVE = NO	Disabled	Disabled
POWER SAVE = YES	Enabled	Enabled
POWER SAVE = AUTO *	Disabled	Enabled

* power save mode for the internal power supply.

Procedure:

- Enter **<P9 OTHER>** according to 11.2. and then:

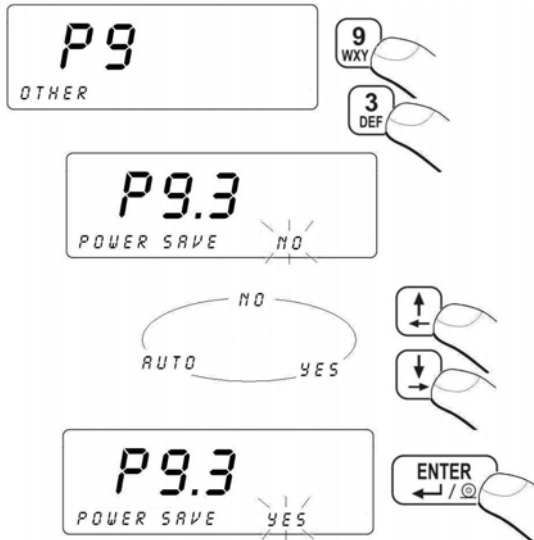

Return to weighing:
See 11.3.

22.5. Backlight

According to the requirements (e.g. intensity of external light) it is possible to:

- Switch on/off or set the backlight operation to AUTO – when supplied from mains,
- Change the backlight intensity in the scale of 0% to 100% - when supplied from an accumulator (lower backlight intensity increases the operation time when supplied from the accumulator).

22.5.1. Backlight – power supply from mains

Procedure:

- Enter **<P9 OTHER>** according to 11.2. and then:

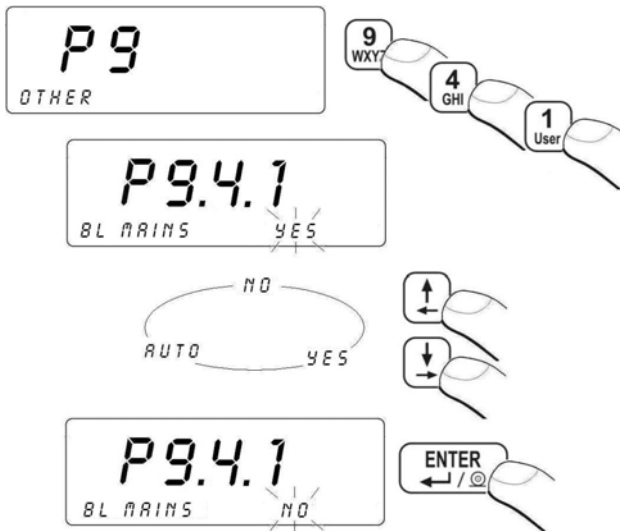

- NO** - backlight switched off
- YES** - backlight switched on
- AUTO** - backlight switched off automatically

Return to weighing:

See 11.3.

22.5.2. Backlight - power supply from the accumulator

Procedure:

- Enter **<P9 OTHER>** according to 11.2. and then:

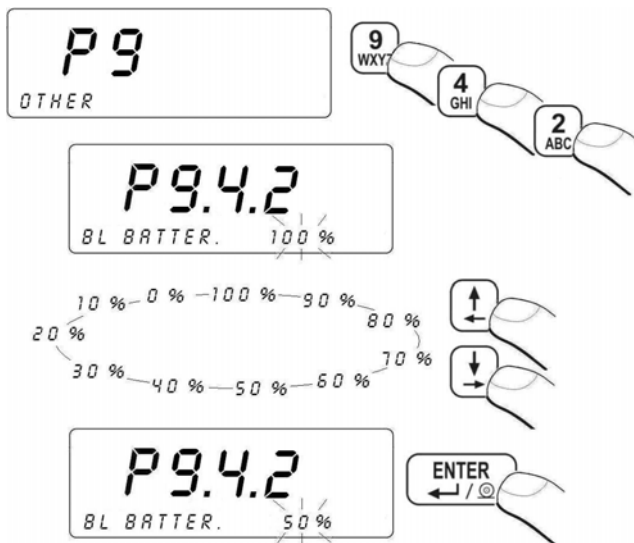

Return to weighing:

See 11.3.

Notice:

Backlight operation shortens time between subsequent recharges of the accumulator.

22.6. “Beep” sound – key-press reaction

Procedure:

- Enter the **<P9 OTHER>** according to 11.2. and then:

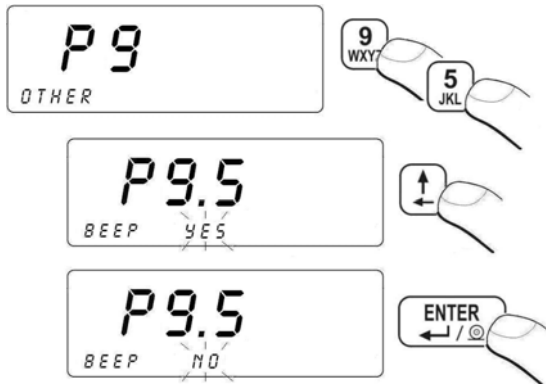

- NO** - no “beep” after pressing keys
YES - “beep” after pressing keys

Return to weighing:
 See 11.3.

22.7. Keypad modes

The program allows to chose between alphanumeric keypad modes for inscribing texts.

Procedure:

- Enter <P9 OTHERS> according to 11.2. and then:

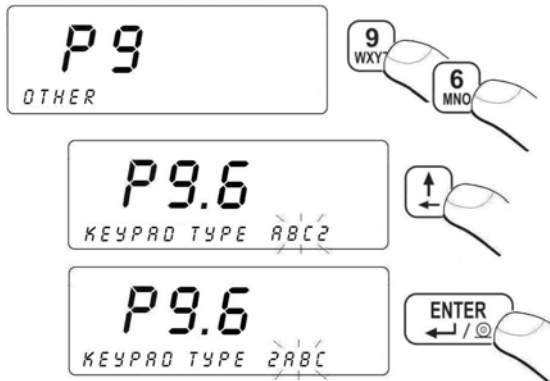

- 2ABC** - Digits come first after pressing a key
- ABC2** - Letters come first after pressing a key

Return to weighing:
See 11.3.

22.8. Software version view

Users <P9.7 SOFT. VER.> can view a software version number.

Procedure:

- Enter <P9 OTHER> according to 11.2. and then:



Return to weighing:
See 11.3.

23. SCALE CALIBRATION

An option only for non-verified scale

Scales require to recalculate internal divisions to more suitable ones (e.g. g, kg etc.). In order to do this they require a calibration factor. It is adjusted during the calibration procedure using a mass standard. Calibration should be made when weighing a standard mass shows a different mass value.

23.1. Calibration procedure

- Enter <P10 USER CALIB.> according to 11.2. and then:

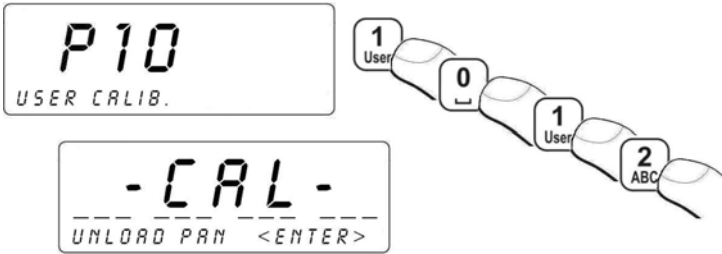

- Unload the pan,
- Press . During adjusting a start mass you will see: **ADJ. START MASS**, in the bottom line,
- After completing this procedure you will see the following window:



- Place the required mass on the platform 1 then press ,
- During the calibration process you will see: **ADJ. CALIB. FACTOR**, in the bottom line.,
- After the procedure is completed you will see in: **UNLOAD THE PAN** in the bottom line,
- After taking off the calibration weight :



- Return to weighing, saving parameters.

Return to weighing:

See 11.3.

23.2. Start mass adjustment

It is possible to adjust only a start mass, it helps to correct the start zero when the span does not change.

Procedure:

- Enter <P10 USER CALIB.> according to 11.2. and then:

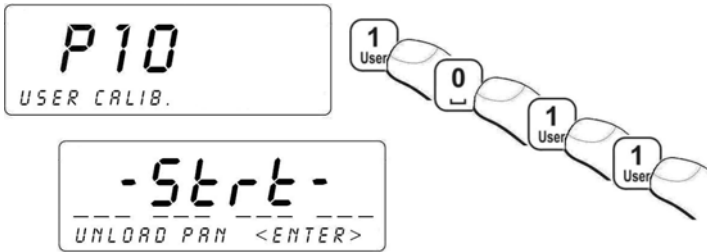

- Unload the scale,
- Press . During adjusting a start mass you will see: **ADJ. START MASS**, in the bottom line,
- After completing this procedure the scale will return to the following window:



- Return to weighing, saving parameters.

Return to weighing:

See 11.3.

24. WORK MODES

24.1. Accessibility of work modes

In **<P7.1 ACCESSIBILITY>** users can declare work modes that are accessible after pressing .

Procedure:

- Enter **<P7 WORK MODES>** according to 11.2. and then:

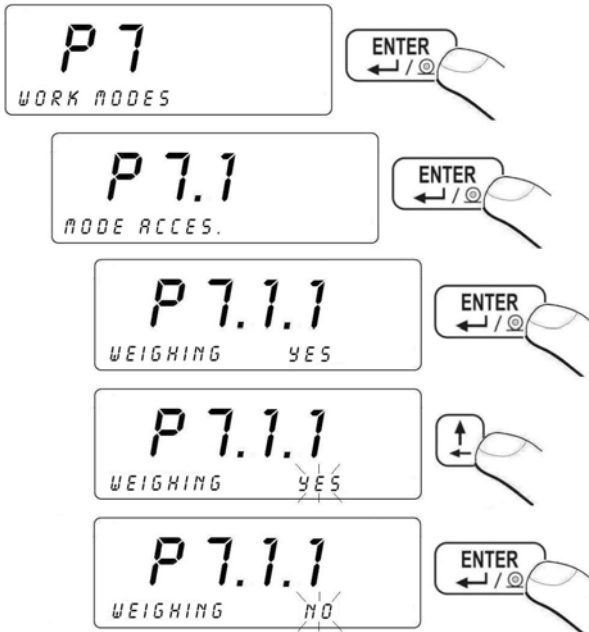

NO - mode denied
YES - mode accessible

Return to weighing:
See 11.3.

Caution:
This way you can disable/enable all accessible work modes.

24.2. Programmable keys

In parameter group **<P7.2 KEY FUNCTIONS>** users can ascribe different functions to keys: **6** (MNO), **7** (PQRS), **8** (TUV), **9** (WXYZ) or **0** () to get an easiest access to different functionalities.

Procedure:

- Enter **<P7 WORK MODES>** and then:



- Using **↓** and **↑** select a key to ascribe (**6** (MNO), **7** (PQRS), **8** (TUV), **9** (WXYZ) or **0** ()).
- Enter the parameter pressing **ENTER** (← / ⏎).
- Using **↓** and **↑** select the required function and press **ENTER** (← / ⏎).

Return to weighing:

See 11.3.

The inventory of functions accessible for ascribing to keys:

Name	Description
DIGIT. SERIES NO	Inscribing 6-digit batch number
ALPHA. SERIES NO	Inscribing 6-character batch number
PRINTOUT 1	Printing non-standard printout No 1
PRINTOUT 2	Printing non-standard printout No 2
PRINTOUT 3	Printing non-standard printout No 3
PRINTOUT 4	Printing non-standard printout No 4
EDIT. PRINTOUT 1	Edit non-standard printout No 1
EDIT. PRINTOUT 2	Edit non-standard printout No 2

EDIT. PRINTOUT 3	Edit non-standard printout No 3
EDIT. PRINTOUT 4	Edit non-standard printout No 4
ASSORTMENT CODE	Quick search of the assortment database using a product code
EAN ASSORT. CODE	Quick search of the assortment database using a product EAN code
STAT. PRINTOUT	Printing statistics
STAT. PRN. DELETE	Printing statistics with deleting counters
STAT. DELETE	Deleting statistics from the last measurement series
TIME VIEW	Time and date view
WEIGH. REPORT	Edit a report from weighings
WEIGH. DATABASE	Direct access to the database of weighings
VAR. 1 ALPHA	Inscribing universal variable No 1 (40 characters)
VAR. 2 ALPHA	Inscribing universal variable No 2 (40 characters)
VAR. 3 ALPHA	Inscribing universal variable No 3 (40 characters)
VAR. . 4 ALPHA	Inscribing universal variable No 4 (40 characters)
VAR. 5 ALPHA	Inscribing universal variable No 5 (40 characters)
VAR. 1 DIGIT.	Inscribing universal variable No 1 (40 digits)
VAR. 2 DIGIT.	Inscribing universal variable No 2 (40 digits)
VAR. 3 DIGIT.	Inscribing universal variable No 3 (40 digits)
VAR. 4 DIGIT.	Inscribing universal variable No 4 (40 digits)
VAR. 5 DIGIT.	Inscribing universal variable No 5 (40 digits)
KEYPAD MODE	Selecting a keypad mode
LO THRESHOLD	Setting minimal mass as a condition of operation some functions
STRT M. ADJ.	Start mass adjustment procedure (user calibration)
CALIBRATION	Span adjustment procedure (user calibration)
AVER. TIME	Averaging time for weighing animals
N1 *	Setting counter N1 (number of weighings which triggers off automatic printing of c label)
M1 *	Setting mass M1 (mass of weighings which triggers off automatic printing of c label)
N2 *	Setting counter N2 (number of weighings which triggers off automatic printing of cc label)
M2 *	Setting mass M2 (mass of weighings which triggers off automatic printing of cc label)
C LABELS NO *	Setting the number of C labels to be printed

CC LABELS NO *	Setting the number of CC labels to be printed
MULTIPLIER *	Setting the recipe multiplier
RECIPE CODE *	Inscribing a recipe code for a quick search of recipes
RECIPE REPORT *	Access to the database of reports from recipes (e.g. for printing them)
CONTRACTOR CODE *	Inscribing a contractor code for a quick search of contractors
MATERIAL CODE *	Inscribing a material code for a quick search of materials
PRINT C *	Printing a C label
PRINT CC *	Printing a CC label
NEW ASSORT.	Adding a new product to the assortment database
NEW CONTRACT. *	Adding a new contractor to the database of contractors
NEW MATERIAL. *	Adding a new material to the database of materials
NEW RECIPE. *	Adding a new recipe to the database of recipes
DIGIT. BATCH NO	Inscribing 10-digit batch number
ALPHA. BATCH NO	Inscribing 10-character batch number
LOSS OF MASS	Loss of mass in per cents

* - This function is not attached to the **STANDARD** software.

24.3. +/- control according to an inscribed standard mass

While in weighing mode users can define (**MIN**, **MAX**).

Procedure:



- Using **0** to **9** numerical keys inscribe a **MIN** threshold and confirm with **ENTER**,

- You will see the following display:



- Using **0** to **9** numerical keys inscribe a **MAX** threshold and confirm with **ENTER**,
- Software returns to **WEIGHING**.

While setting these thresholds following features are important:

- Symbols: **Min**, **OK**, **Max** in the upper line of the display:

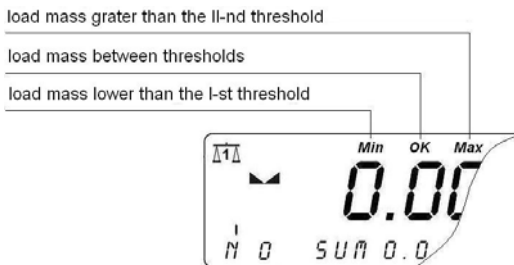

- Designation of the proper interval (OK) on the bargraph:

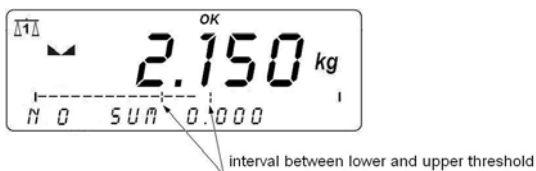

- Three **fields of signalling LEDs** over the display:
 - Left – red** – when this field shines the mass is lower than the **Min** threshold;
 - Middle – green** – Designation of the proper interval **OK** between **MIN** and **MAX** thresholds;
 - Right – red** – when this field shines the mass is higher than the **Max** threshold.

Notice:

Users can use this function in other work modes like counting pieces, weighing in percents etc. Only values and units can change.

24.4. Maximal force latch

Procedure:

- Enter the **TOP** work mode:

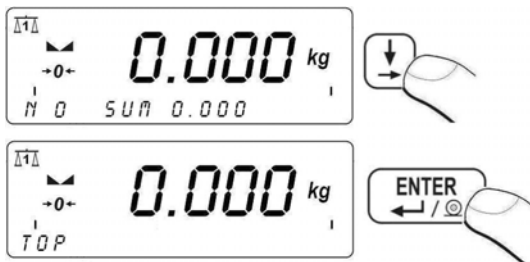

- **TOP** selection is signalled by the **Max** pictogram in the upper line of the display:



- When a force acting on the pan changes on the display only the maximal value can be seen,
- Remove the acting force,
- Press **+0+** before the next measurement.

Return to weighing:

See 11.3.

24.5. Counting pieces

The standard software is equipped in a counting pieces procedure. If counting pieces is to be proceeded in a package/container, tare the package/container first.

24.5.1. Enabling work modes

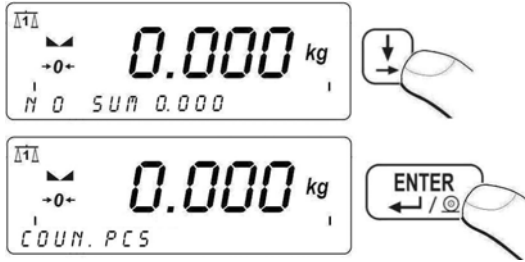

- **COUNTING PCS** procedure is active when  pictogram is displayed.

24.5.2. Setting standard mass by inscribing the mass of a single piece

Procedure:

- Enter **COUNTING PCS** and then:

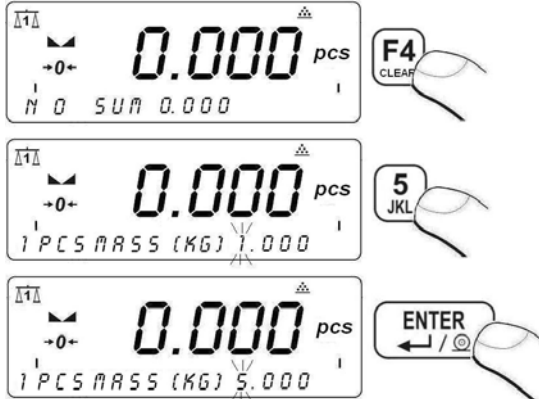

Press  to initialise **COUNTING PCS**, with automatic setting of standard mass.

Notice:

The mass of a single piece cannot be lower than 0.1d and greater than the full scale.

24.5.3. Setting the standard mass by declaring the quantity of a sample

Procedure:

- Enter **COUNTING PCS.** and then:

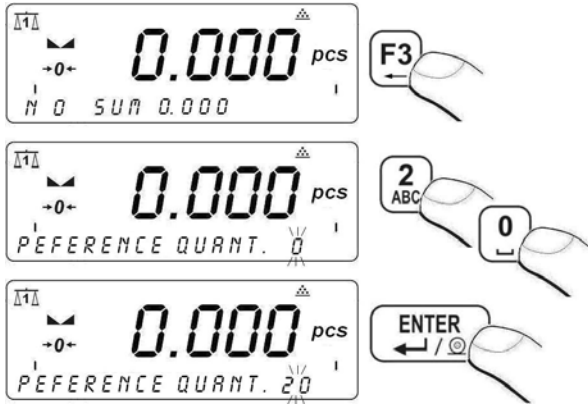

While inscribing a sample quantity it should be remembered that the mass of a single piece should not be lower than **0.1 d** and the total mass of a sample (all pcs) should not be lower than **1 d**. An error appears when this two conditions are not performed.

- After inscribing a required sample quantity press **ENTER** and you will see:

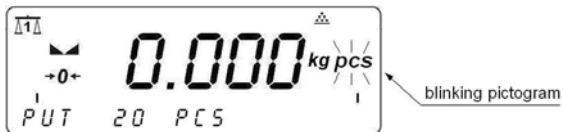

If pieces are to be weight in a container put the container first and tare it. Then put a load of pieces, wait for the equilibrium (▲▼) confirm it by pressing **ENTER**.

Software automatically calculates a single piece mass and goes to **Counting pieces:**



Notice:

If a user confirms a sample with  with the empty weight pan, **<Err6>** will be displayed.

Return to weighing:

See 11.3.

24.6. Deviation in percents in relation to a standard mass

Software can help to control deviations (in %) from a standard (nominal) mass. The standard mass can be settled by weighings or inscribing.

24.6.1. Starting weighing in per cents





- Selection of **DEVIATIONS** is confirmed by displaying “%” pictogram in the upper right corner of the display.

24.6.2. Weighing a standard mass

Procedure:

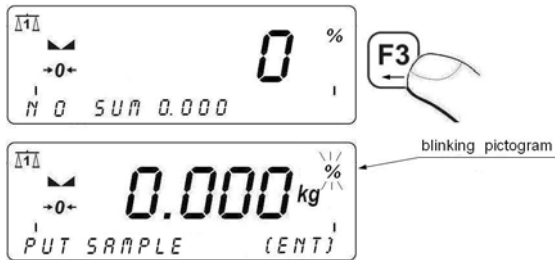
- Enter **DEVIATIONS** and then:



- Put a load to be a standard mass on the weight pan,
- After the equilibrium is reached (▲) press ,
- You will see the indication of **100,00%**,
- From this moment all results will be displayed in percents:



Return to weighing:
See 11.3.

24.6.3. Inscribing a standard mass

Procedure:

- Enter **DEVIATIONS** and then:

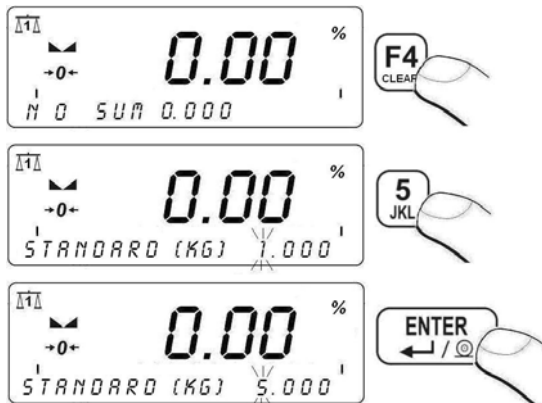

From this moment all results will be displayed in percents.



Return to weighing:
See 11.3.

24.7. Weighing animals

24.7.1. Weighing time setting

Users can set in seconds the time of weighing an animal.
During this time averaging is performed.

Procedure:

- Enter **<P7 WORK MODES>** and then:

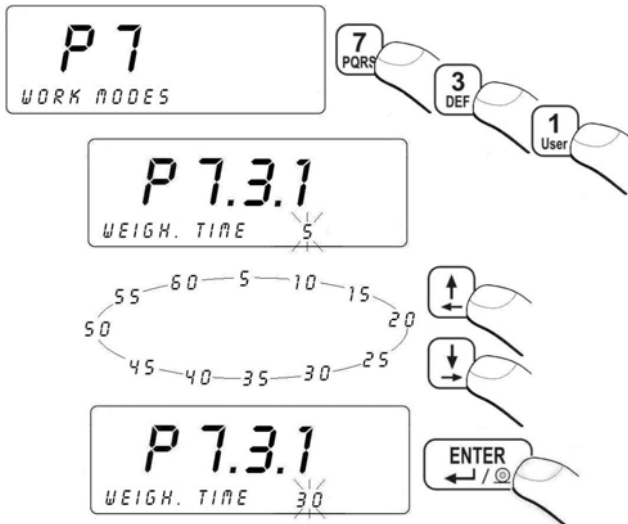

Return to weighing:
See 11.3.

24.7.2. Starting the work mode

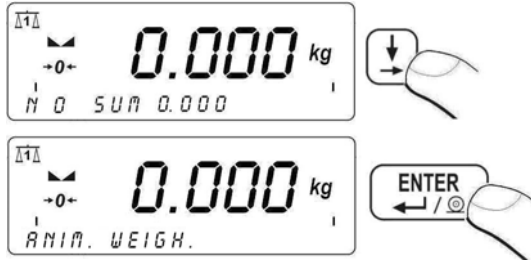

- **WGH. ANIMALS** mode is signalled by showing ► pictogram in the right side of the picture.

24.7.3. Procedure of weighing animals

- After starting **ANIM. WEIGH.** (see 24.7.2) put the animal on the platform,
- Press **F3** to start the process of weighing,
- You will see a set of dashes on the display <-----> showing the progress of weighing during the time set in **<P7.3.1 WEIGH. TIME>** - (see 24.7.1),
- After the procedure of weighing is completed the result will be latched,
- Additionally you will hear a short “beep” sound and see **Hold** pictogram in the left part of the display:



- Before initiating the next weighings press **-0+** key,
- Weighing procedure can be terminated while in progress by pressing **ESC**.

Return to weighing:

See 11.3.

24.8. Dosing

Standard indicators are equipped with signalling fields and internal circuit of - 3 optoinsulated inputs (5÷24V DC), 3 optoinsulated reed relay outputs.

Caution:

1. Working mode „Dosing” does not support continuous printouts;
2. See an example application in chapter 32.3 of this manual.
3. Inductive loads connected to the dosing indicator should have protections against the coil induction phenomenon. Example connetion diagrams of dosing indicators outputs with direct and alternative current protections are in point 32.6 of the manual.

24.8.1. Dosing mode setting

Users can chose one of three different modes <P7.4.1 DOSING NAM.>.

Procedure:

- Enter <P7 WORK MODES> and then:

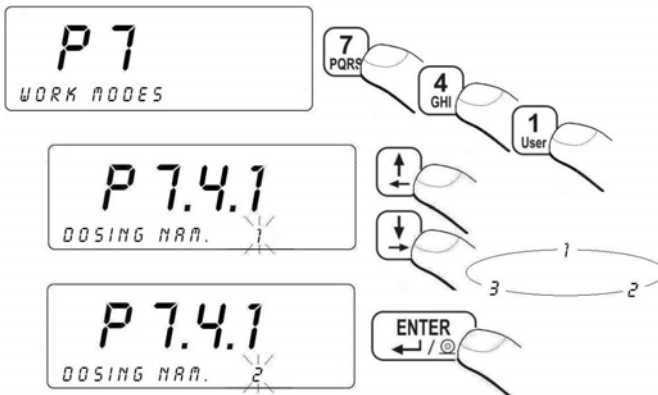

- 1 - manual operation (after pressing **F3**),
- 2 - automatic operation,
- 3 - „-” negative dosing (after tarring **+T+** and pressing **F3**).

Return to weighing:

See 11.3.

24.8.2. Time interval between changing dosage thresholds

By setting <P7.4.2 DELAY> parameter users can set a delay time between changing dosing thresholds.

Procedure:

- Enter <P7 WORK MODES> and then:

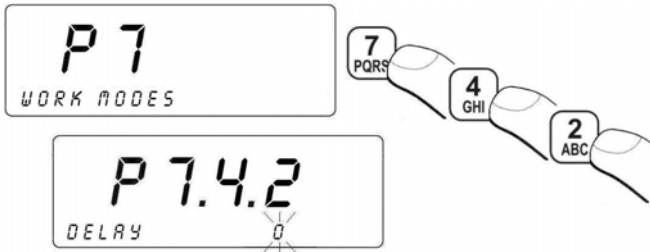

- Using numeric keys inscribe the required value (0 to 60 s) and confirm by pressing .

Return to weighing:
See 11.3.

24.8.3. Time interval completing process

Users can set <P7.4.3 CHUTE TIME> parameter to change time of completing a process of dosing after indication drops below LO.

Procedure:

- Enter <P7 WORK MODES> and then:

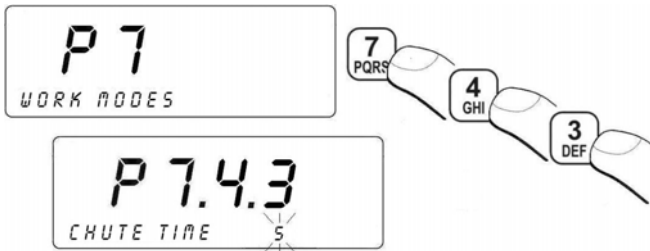

Using numeric keys inscribe a requires value (0 to 60 s) and confirm by pressing .

Return to weighing:
See 11.3.

24.8.4. Mode for OUTPUTS

Software includes three different algorithms operating on OUTPUTS that allows the device to readjust to the customer's requirements.

Procedure:

- Enter **<P7 WORK MODES>** and then:

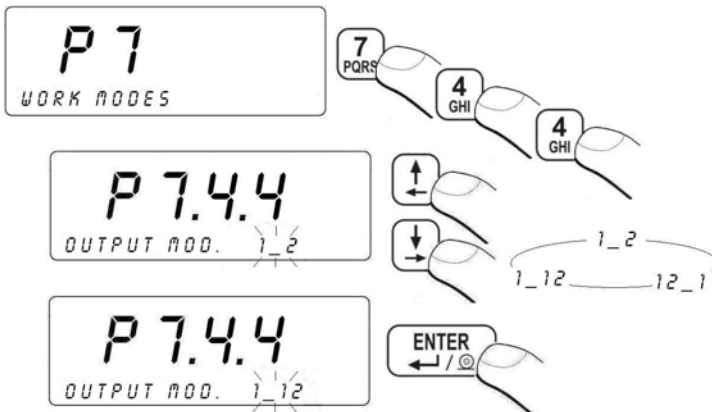

OUTPUT MOD.	Threshold	Rough dosing	Precise dosing
1_2	THERSHOLD 1	1	0
	THERSHOLD 2	0	1
12_1	THERSHOLD 1	1	1
	THERSHOLD 2	1	0
1_12	THERSHOLD 1	1	1
	THERSHOLD 2	0	1

Return to weighing:
See 11.3.

Caution:

If dosing is initiated when the indication is **> LO**, after reaching the indication below **LO** output (outputs) will be automatically switched on. Subsequent dosing process can be started when indication goes below **LO**.

24.8.5. Tarring mode setting

The parameter **<P7.4.5 TARRING>** allows to enable/disable automatic tarring in **DOSING** mode.

Procedure:

- Enter **<P7 WORK MODES>** and then:

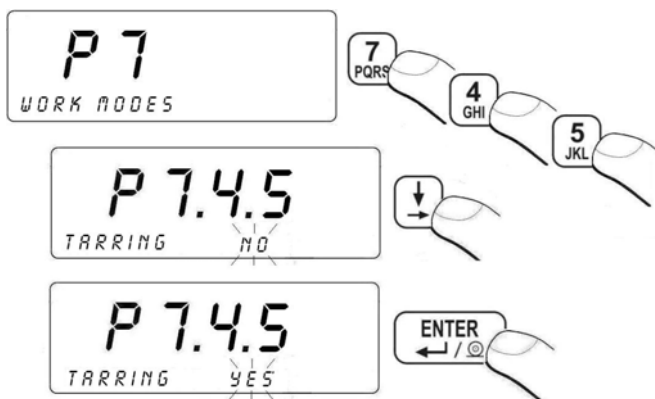

Return to weighing:

See 11.3.

24.8.6. Corrections

Work mode **<DOSAGE>** can have automatically corrected nominal mass in the dosing procedure that allows to optimize the procedure considering pressure changes of dosed substance in the hopper or other container. In parameters' group **<P7.4.6 DOSING CORRECTIONS>** users can set parameters that refer to introducing mass correction.

24.8.6.1. Correction mode

Procedure:

- Enter **<P7 WORK MODES>** and then:

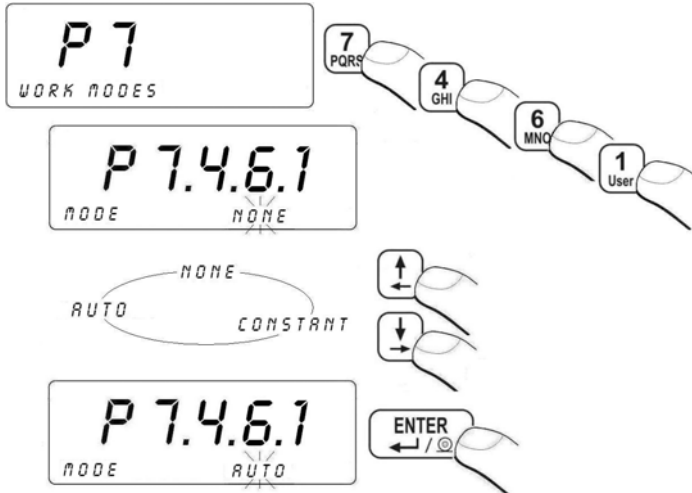

- NONE** - Correction function disabled
- CONSTAN** - Dosing referred to a constant nominal value of
- T** correction
- AUTO** - enabling automatic correction

Return to weighing:

See 11.3.

24.8.6.2. Initial correction value

In parameter **<P7.4.6.2 START CORRECTION>** a user can set a mass value to be subtracted from or added to the nominal mass.

Procedure:

- Enter **<P7 WORK MODES>** and then:

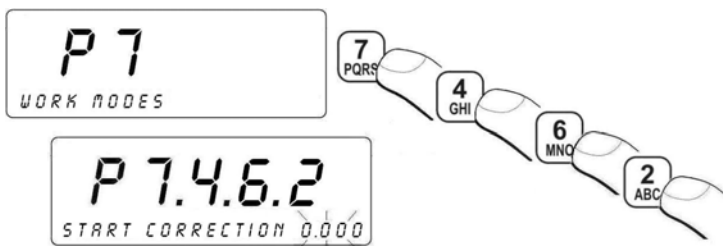

- Use the scale keyboard a starting correction value and confirm it by pressing .

Notice:

1. The starting correction value is estimated experimentally in at least 2 subsequent cycles of dosing;
2. In correction mode **<CONSTANT>**, the start correction is always the correction value, but in correction mode **<AUTO>** the declared start value is used only in the first dosing cycle. Then it can be modified.

Return to weighing:

See 11.3.

24.8.6.3. Maximum correctional value

The introduced maximum value in parameter **<P7.4.6.3 MAX CORRECTION>** for corrections is intended to limit the range of operation for automatic calculation of correctional value.

Procedure:

- Enter **<P7 WORK MODES>** and then:

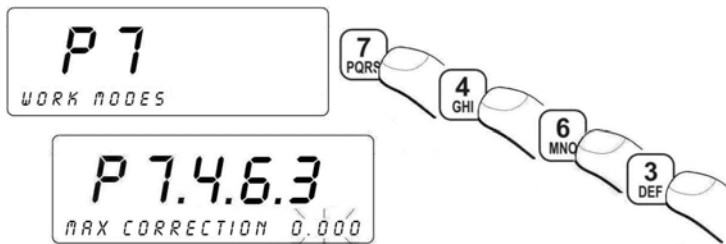

- Use a keyboard to enter a maximum value for the process and confirm it by pressing .

Return to weighing:

See 11.3.

24.8.6.4. Averaging from subsequent dosing cycles

In parameter **<P7.4.6.4 AVERAGING VALUE>** users can set a number of subsequent dosing cycles to consider for calculating the correctional value. Averaging is always calculated from subsequent dosing cycles.

Procedure:

- Enter **<P7 WORK MODES>** and then:

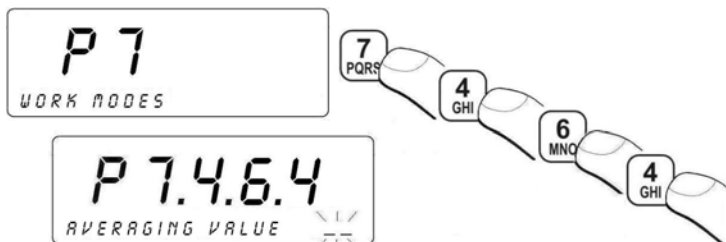



- Enter the required number of dosing cycles using the scale keyboard (acceptable settings are **1** to **10**) and confirm it by pressing .

Return to weighing:

See 11.3.

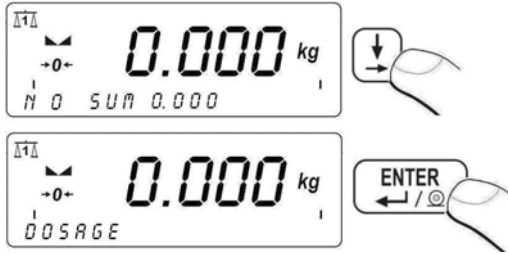
24.8.7. Starting work modes



After entering the **DOSING** mode the  pictogram is displayed. Press **F3** to start a dosing process. After starting it  starts blinking, keyboard is blocked until the process is completed.

The process completion is signalled by displaying a message:
< **END OF DOSING** > in the bottom line of the display:



This process can be stopped only by pressing **F4** CLEAR. A message will be displayed in the bottom line: < **STOP DOSING** >.



When the procedure is broken or completed  is displayed continuously.

Dosing process can be also terminated by pressing **F2** DEL. You will see:



Pressing **F3** will cause the process to continue.

Pressing **F4** will cause the process to break.

Return to weighing:
See 11.3.

25. DIAGRAMS OF CONNECTION CABLES

The scale in **STANDARD** version can cooperate with:

- computers
- slip printers KAFKA, EPSON, KYOLINE
- label printers CITIZEN, ZEBRA,
- external buttons PRINT, TARA, ZERO,
- internal I/O module of 3 optoinsulated inputs / 3 reed relay outputs.

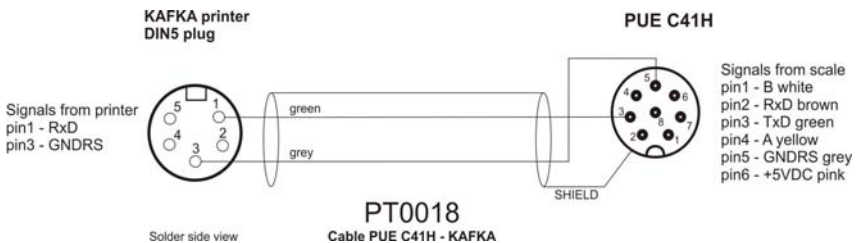
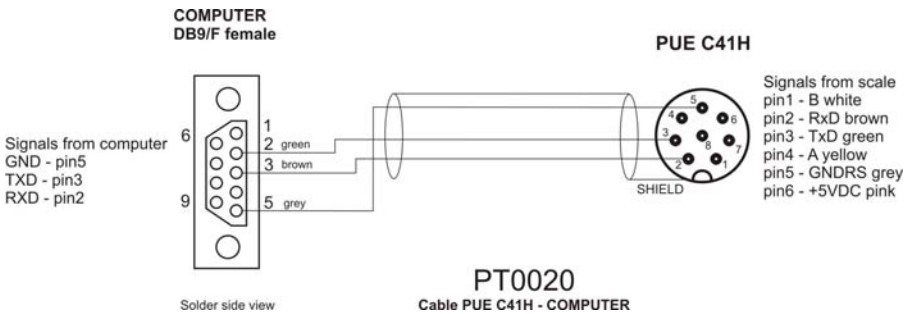

Scale – Kafka or scale KyoLine printer cable

LS2208 RS232

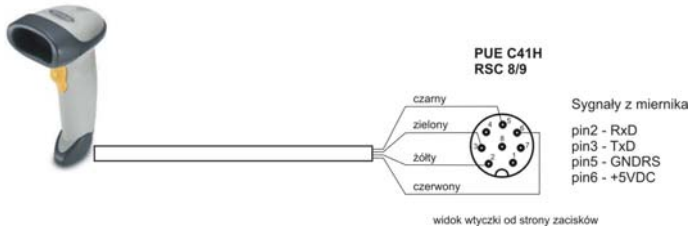

Scale – barcode scanner (LS2208)

**EPSON, CITIZEN printer
DB25/M male**

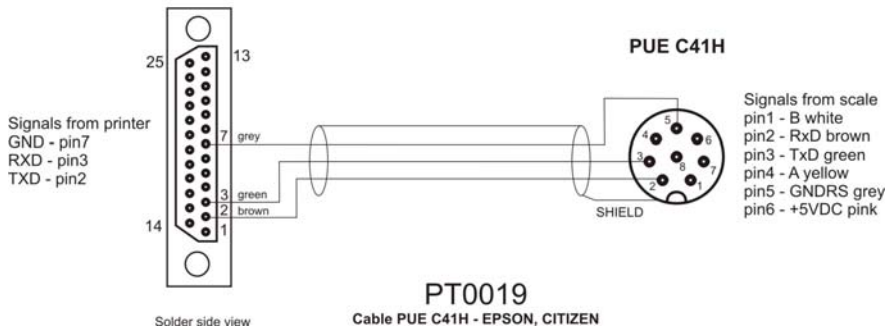

Scale – printer (CITIZEN, EPSON) cable

**ZEBRA printer
DB9/M male**

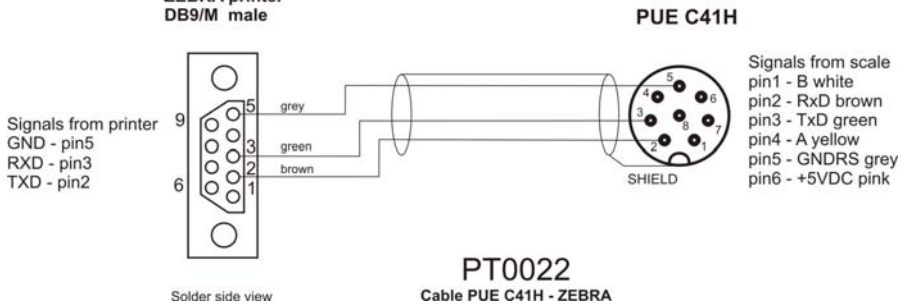

Scale – Zebra printer cable



Cable PUE C41H - 3IN/3OUT (RSTS-8-184-2M)

Scale - 3IN/3OUT (RSTS-8-184/2M) cable

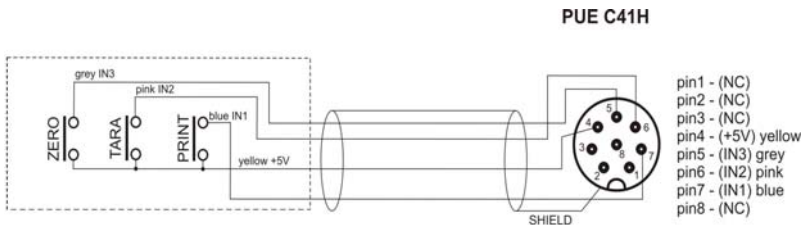

Possibility of optional configuration of inputs from the level of PUE C41H software

PT0021

External Buttons PRINT, TARA, ZERO to PUE C41H

PRINT, TARA, ZERO external buttons cable

26. CONNECTORS

Caution:

In accordance to the number of mounted modules the number and the placement of glands and connectors can vary. Connectors and glands mentioned in the standard solution appears in every option in the same place regardless of the option.

26.1. 3IN/3OUT connector

- **Colours of cable 3IN/3OUT conductors**

Cable “M12” 8pin (e.g.: RSTS 8 -184/2M)

INPUTS		OUTPUTS	
description	wire colour	description	wire colour
GND IN	RED	COMMON	YELLOW
IN1	BLUE	OUT1	GREEN
IN2	PINK	OUT2	BROWN
IN3	GREY	OUT3	WHITE

- **Description of connector 3IN/3OUT**

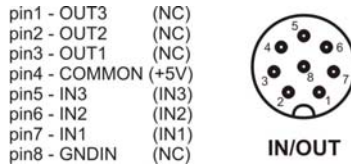

3IN/3OUT connector

Exemplary scheme of connections for inputs:

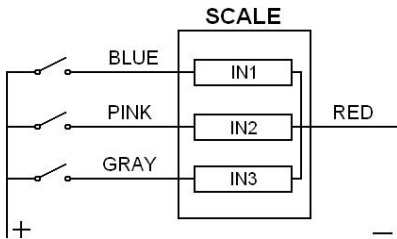

*Voltage for inputs:
from 5V DC to 24V DC*

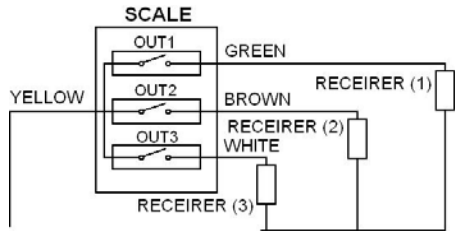

*Max voltage for outputs:
24V 0,5A DC/AC*

26.2. RS232, RS485 connector

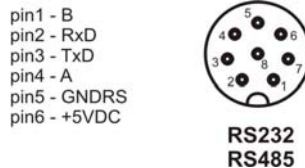

RS232, RS485 connector

27. SPECIFICATION OF ADDITIONAL MODULES

Apart from standard interface, it is possible to equip terminals with additional module increasing functionality of devices:

- **ET** - Ethernet module,
- **AN** - analogue outputs module,
- **PK 1** - relay outputs module,
- **WE 8** - 8 inputs / 8 outputs module,
- **WE 4** - 4 inputs / 4 outputs module,
- **DP 1** - Additional A/D converter module (for second platform)
- **RS D1** - RS485 led out via a gland

Main board view with some additional modules being installed:

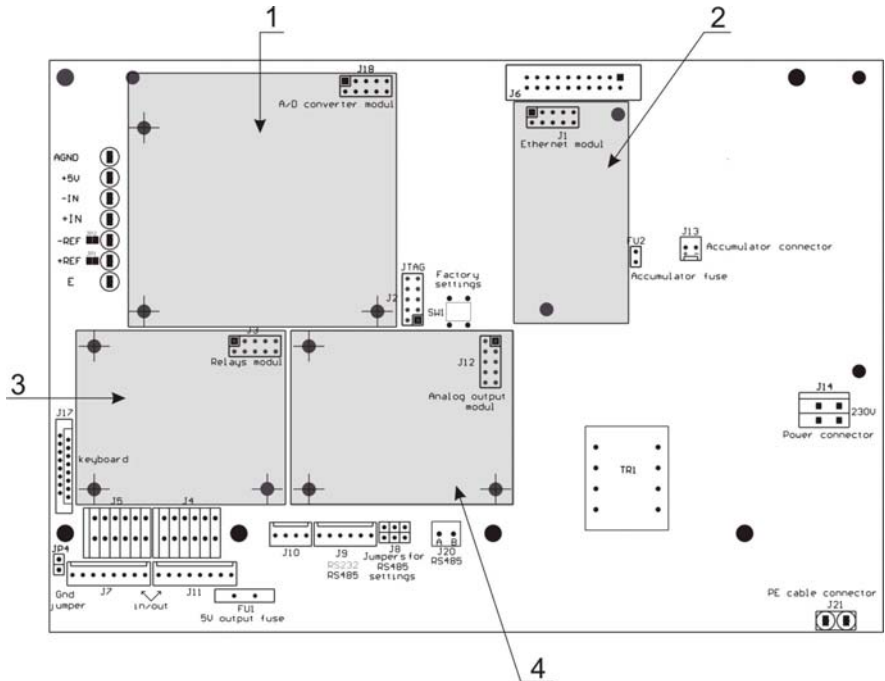

- 1 - additional A/D module,
- 2 - Ethernet module,
- 3 - relay outputs module,
- 4 - analogue output module.

Main board view with connectors for additional modules:

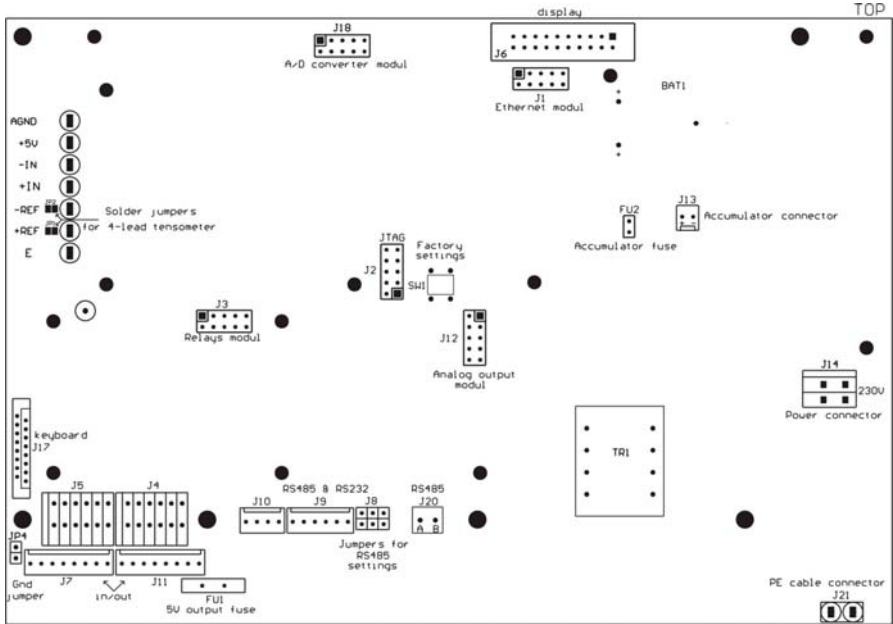

- J18 – DP 1 module
- J1 – Ethernet ET 1G, ET 1 D module
- J3 – Relay module
- J12 – WE 8 module
- J12 – AN module

27.1. Ethernet module - ET

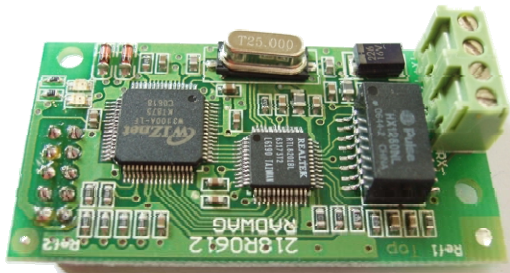

Ethernet module PCB

This module is designed according to TCP/IP 10/100 Mbit/s standard. It comprises two signalling LED's:

- D2 lights - Ethernet connection established,
- D1 blinks - transmission 10Mbit/s or 100Mbit/s.

Module accessible in two versions:

ET 1G : with external connector on the scale housing;

ET 1D : with cable (twisted pair) about 3m length led out via the gland on the scale housing Intended for connecting to a switch (not computer). Terminated with a standard RJ45 plug.

27.1.1. Mounting way in PUE C41H

This module is intended for mounting inside PUE C41H indicators. It is mounted to the main board to the 10-pin **J1** connector.

- For **ET 1G** version of module a 4-pin Ethernet connector is installed on the back wall of the housing.
- For **ET 1D** version of module a gland is installed on the back wall of the housing through which a shielded cable is led out (twisted pair 3m length terminated with RJ45 plug).

Mounting procedure:

1. Unplug from mains;
2. Unscrew the back wall of the housing;
3. Install the module in **J1** on the main board;
4. During installation turn your attention to plastic columns. They should be placed one side in mounting holes in the main board and the other side in the mounted module;
5. For ET 1G unscrew one of the plugged glands and install a socket instead;
6. For ET 1G version connect wires from **PT0017** socket to **J2** and **J3** connectors on the Ethernet module according to the description below;
7. For ET 1D version unplug one of the glands and led the **PT0014** (twisted pair) cable out;
8. For ET 1D version connect the shield of **PT0014** cable to the indicator housing (screwed terminator, 4mm diameter);

9. Connect the **PT0014** cable to **J2** and **J3** connectors on the Ethernet module according to the description;
10. Cable (twisted pair) or wires from the Ethernet socket connect to the group of wires (unhook band clips fastening the group of wires, lay the cable or conductors from the socket and hook the band clips).
- Band clips of multiple usage;
11. Screw down the back wall.

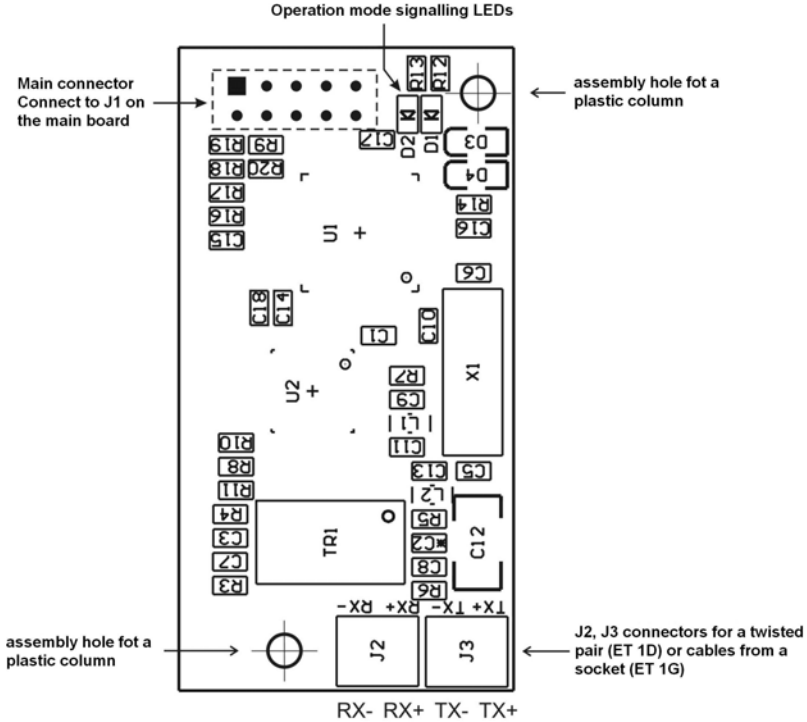

- | | | | |
|--------------------|---|----|---|
| TX+ white - orange | } | J3 | Colours of wires in the twisted
pair cable from PT0014 for ET 1D |
| TX- orange | | | |
| RX+ white - green | } | J2 | |
| RX- green | | | |
| TX+ white | } | J3 | Colours of cables from PT0017 for ET 1G |
| TX- blue | | | |
| RX+ yellow | } | J2 | |
| RX- orange | | | |

Ethernet module on the main board of PUE C41H

27.1.2. Drawings of sockets and cables for Ethernet

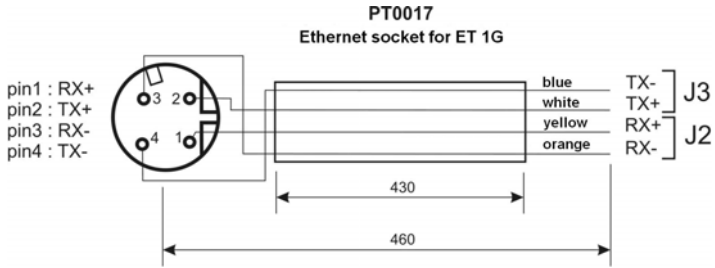

Ethernet socket for ET 1G version

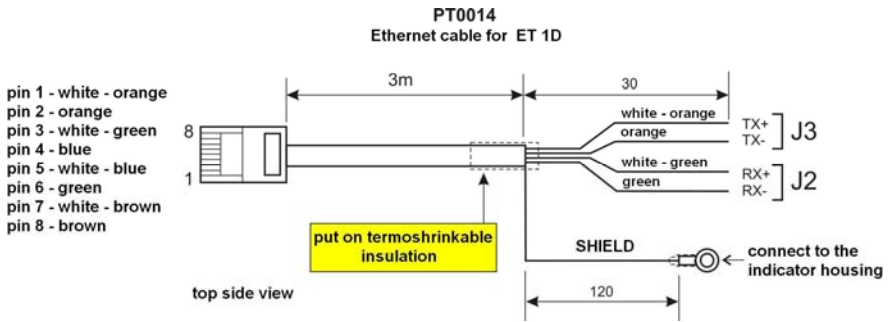

Ethernet cable for ET 1D (version for a SWITCH)

27.2. Module of Analogue Outputs

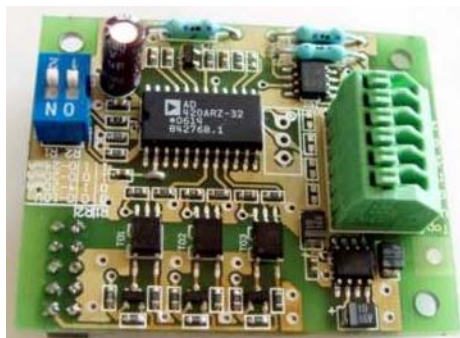

Module of analogue outputs

Module accessible in three configurations:

- Voltage output AN 0-10V
- Current output AN 4-20mA
- Current output AN 0-20mA

27.2.1. Technical specification

Work modes	4 - 20mA , 0 - 20mA, 0 - 10V
Resolution	16 bit
Current output resistance	<500Ω
Voltage output resistance	>400Ω
Power supply	24V DC (12 - 30V DC) max 40mA

27.2.2. The way of installing inside PUE C41H

These modules are intended to mount inside PUE C41H. They need to be connected to the 10-pin J12 connector. For all configurations of AN, there is a gland installed on the back wall of the housing. A 3-meter shielded cables are led out via the gland. Wires should be free from insulation.

Installation procedure:

1. Unplug the scale from mains;
2. Unscrew and take off the back wall of the housing;
3. Install your module in J12 on the main board;
4. During installation turn your attention to plastic columns. They should be placed one side in mounting holes in the main board and the other side in the mounted module;
5. Led the PT0015 cable through one of the free glands;
6. Connect the PT0015 cable to J3 on the analogue module according to the description below;
7. Connect the PT0015 cable shield to the housing (screwed terminator, 4mm diameter);
8. The cable connect to the group of wires (unhook band clips fastening the group of wires, lay the cable and hook the band clips). Band clips of multiple usage;
9. Screw down the back wall.

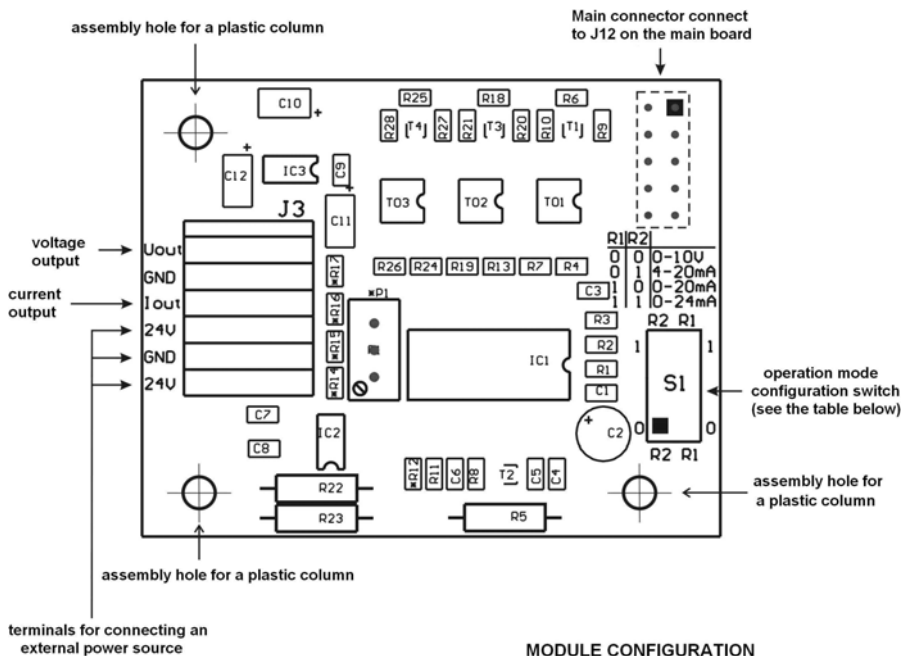

MODULE CONFIGURATION

R1	R2	Operation mode
0	0	0-10V
0	1	4-20mA
1	0	0-20mA
1	1	0-24mA

ANALOGUE OUTPUTS' MODULE CURRENT LOOP 4-20 mA SET AS DEFAULT

Mounting of **AN** module on the main board of PUE C41H

27.2.3. Configuration of work modes of analogue modules

A work mode of analogue modules can be set using **S1** switch according to the drawings above (table „configuration of analogue modules”). Near the **S1** switch on the PCB you can find a description.

27.2.4. Connections to AN module

Drawing of connections of voltage output:

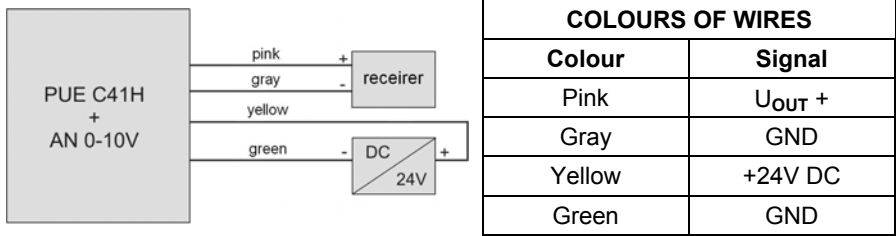

Drawing of connections of current loop:

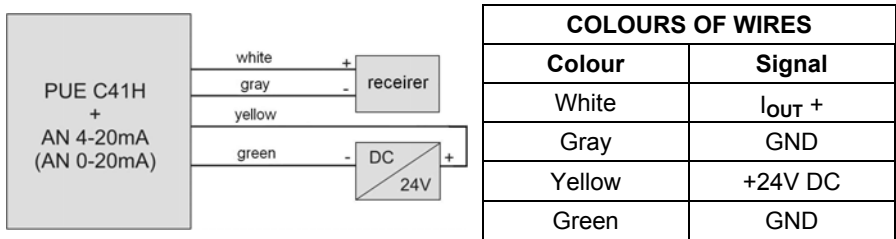

PT0015 Analogue outputs' cable

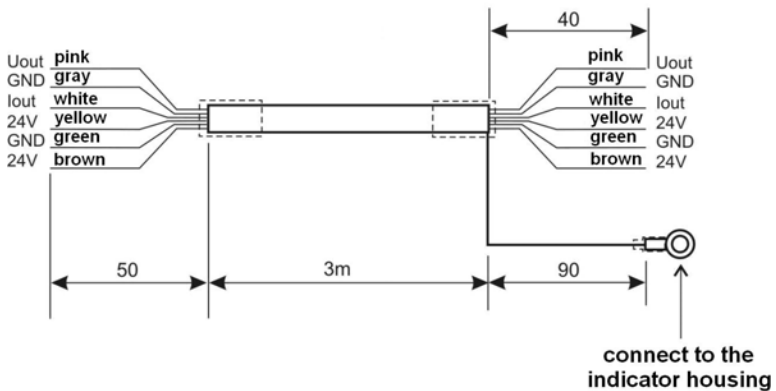

Cable for analogue output

27.3. Relay module - PK1



Relay module PCB - PK1

This is an alternative solution for reed relay outputs present on the main board in the standard solution. The usage of this module excludes the usage of standard reed relay outputs. The advantage of using this module are the electrical parameters of contacts. All outputs can be freely configured (from the level of parameters). The cable is led out via a gland on the back wall of the housing (3m length).

Caution:

PK1 modules constitutes an alternative solution for reed relays present on board. Using this module disables reed relays' outputs.

27.3.1. Technical specification

Quantity of relays	4
Wire diameter	0,14 ÷ 0,5mm ²
Current-carrying capacity of contacts	230V AC - 2A, 30V DC - 2A

Caution:

When inductive load it is advisable to use a suppression circuit (LC or voltage-dependent resistors) installed next to the receptor. Parameters of these circuits are determined by clients.

27.3.2. Installing in PUE C41H indicators

These module are intended to mount inside PUE C41H indicators. It is mounted to the main board to the 10-pin **J3** connector. An additional gland is installed on the back wall and a 3m cable is led out through it. Wires should be free from insulation.

Installing procedure:

1. Unplug the scale from mains;
2. Unscrew and take off the back wall of the housing;
3. Install your module in **J3** on the main board;
4. During installation turn your attention to plastic columns. They should be placed one side in mounting holes in the main board and the other side in the mounted module PK1;
5. Led the **PT0016** cable through one of plugged glands;
6. Connect the **PT0016** cable to **J2** connector on the PCB according to the description below;
7. The cable connect to the group of wires (unhook band clips fastening the group of wires, lay the cable and hook the band clips). Band clips of multiple usage;
8. Screw down the back wall.

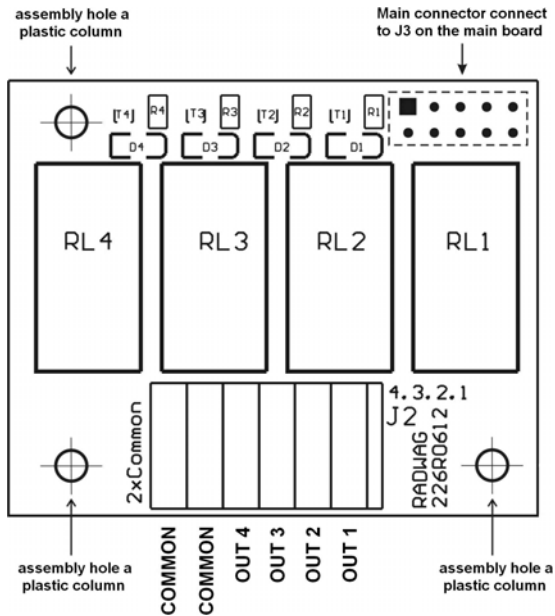

Installing a PK1 module on the main board of PUE C41H

27.3.3. Drawing of cables and outputs

Relay outputs diagram:

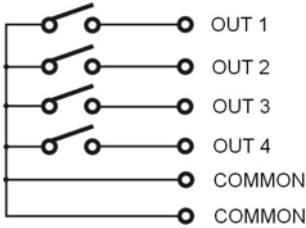

SIGNALS AND DESIGNATIONS OF CONDUCTORS	
Wire number	Description
1	OUT 1
2	OUT 2
3	OUT 3
4	OUT 4
5 (yellow - green)	Common

27.4. WE 4 - 4 inputs / 4 outputs module

WE 4 module comprises 4 optoinsulated inputs and 4 optoinsulated outputs of reed relays. The input / output wires are led out via a gland on the back wall of the housing (3m length).

Caution:

As standard indicator is equipped with 3 in and 3 out sockets.

27.4.1. Technical specification

Parameters of outputs	
Quantity of outputs	4
Type of outputs	Reed operation contacts
Wire diameter	0,14 - 0,5mm ²
Maximal load-current contact capacity	0,2A DC
Maximal forward voltage	50V DC
Parameters of inputs	
Quantity of inputs	4
Input type	Optoinsulated
Wire diameter	0,14 – 0,5mm ²
Control voltage range	5 -24V DC

27.4.2. Colours of cables for I/O

INPUTS		OUTPUTS	
wire number	description	wire number	description
1	IN 1	6	OUT 1
2	IN 2	7	OUT 2
3	IN 3	8	OUT 3
4	IN 4	9	OUT 4
5	GND IN	10 (yellow - green)	COMMON

27.4.3. Installing method in PUE C41H indicators

WE 4 modules are equipped in two cables, one for inputs and one for outputs.

Installing procedure:

1. Unplug the scale from mains;
2. Unscrew and take off the back wall of the housing;
3. If inputs and outputs are installed at the same time, dismount I/O socket and install a PG9 gland instead. LED the **PT0016** cable through it (the same way like in case of relay outputs). If only 4 inputs or 4 outputs are installed unplug one of the existing glands and led the **PT0016** cable through it.
4. Connect the **PT0016** cable to the **J5** connector for inputs or to the **J4** for outputs, on the main board of PUE C41H.
5. The cable connect to the group of wires (unhook band clips fastening the group of wires, lay the cable and hook the band clips). Band clips of multiple usage;
6. Screw down the back wall.

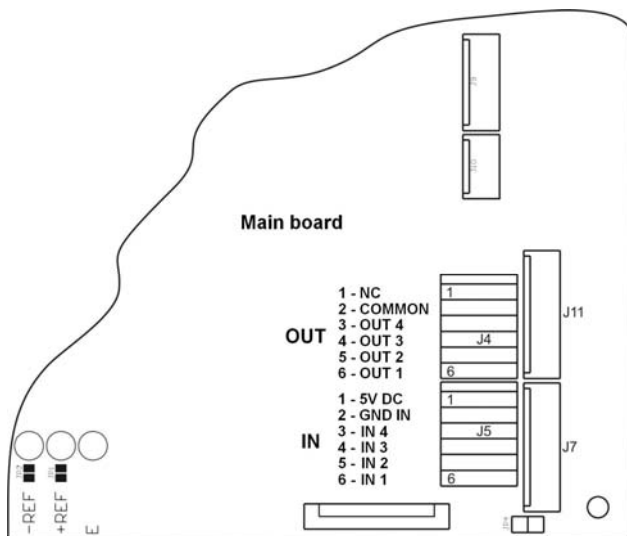

Installing WE4 modules on the main board of PUE C41H

27.5. WE 8 - 8 inputs / 8 outputs module



8 inputs / 8 outputs PCB - WE 8

WE 8 modules can be connected as an alternative to the module of analogue output and relay module. Its task is to expand the functionality of an indicator for 8 inputs and 8 outputs freely configurable. It expands functionality of terminals. It comprises on board optoinsulated inputs and outputs freely configurable from the level of indicator.

Caution:

*If **WE 8** module is installed in it does not allow to install **AN** analogue output module and/or **PK 1** module of relays.*

27.5.1. Technical specification

Parameters of outputs	
Quantity of outputs	8
Type of outputs	Reed operation contacts
Wire diameter	0,14 - 0,5mm ²
Maximal load-current contact capacity	0,2A DC
Maximal forward voltage	50V DC
Parameters of inputs	
Quantity of inputs	8
Input type	Optoinsulated
Wire diameter	0,14 – 0,5mm ²
Control voltage range	5 -24V DC

27.5.2. Installing method in PUE C41H indicators

Module is designated for assembly inside indicator PUE C41H. Module is assembled to main board of indicator to 10-pin **J12** connector. For module **WE8** gland is installed on casing lid, 3m cable ended with insulated conductors is led through gland.

Installing procedure:

1. Unplug the indicator (remove the plug from socket 230V);
2. Unscrew the casing lid (back part of indicator casing);
3. Install the module in connector **J12** on main board;
4. While installing module pay attention to plastic posts fastening to main board. They should be placed in assembly holes in main board and in assembly holes in module WE 8,
5. In one of free glands remove the stopper and led through it cable IN/OUT (if necessary use bigger gland depending on cable diameter);
6. Connect the cable IN/OUT to joint **J1**, **J2** for outputs and **J3**, **J4** for inputs on module 8IN/8OUT according to description given in table;
7. Connect cable IN/OUT to group of conductors (undo band clips fastening group of conductors, lay the cable and clamp band clips – multiple use band clips);
8. Assembly cover of indicator casing.

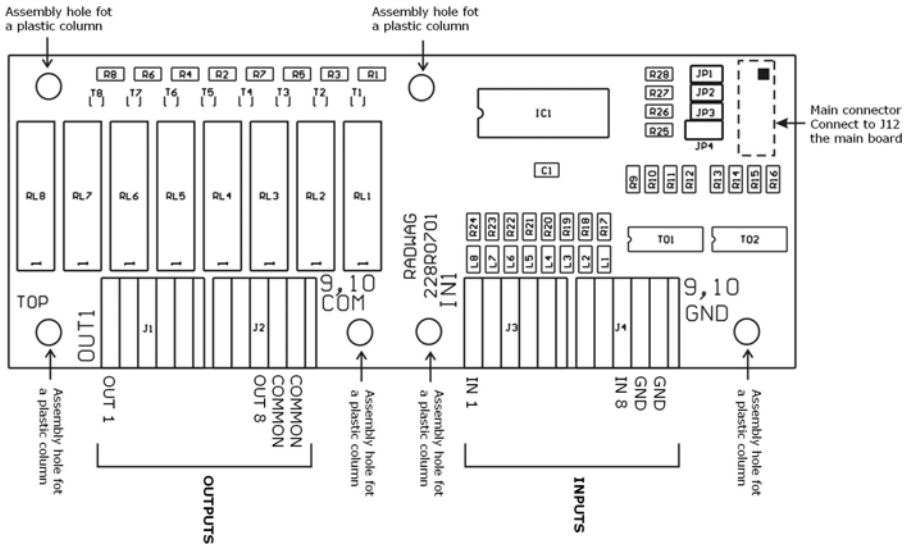

A WE 8 module placement on the main board of PUE C41H

27.5.3. I/O diagram

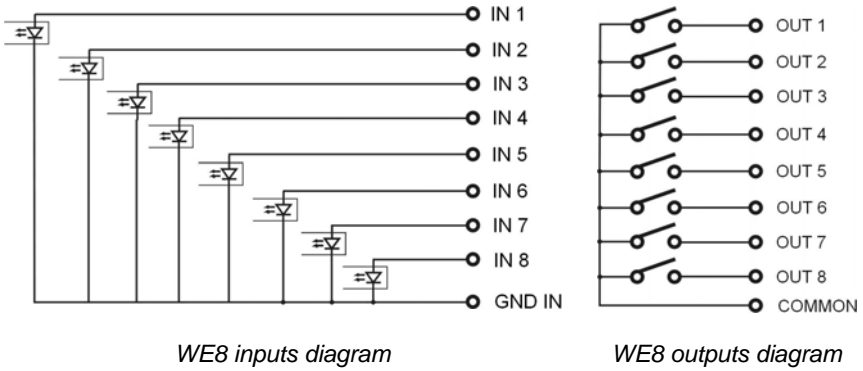

WE8 inputs diagram

WE8 outputs diagram

27.5.4. Description of input output wires

Signals led out with two cables 10x0,5mm² with numbered conductors.

INPUTS		OUTPUTS	
Wire number	description	Wire number	description
1	IN 1	1	OUT1
2	IN 2	2	OUT2
3	IN 3	3	OUT3
4	IN 4	4	OUT4
5	IN 5	5	OUT5
6	IN 6	6	OUT6
7	IN 7	7	OUT7
8	IN 8	8	OUT8
9	GND IN	9	COMMON

27.6. DP1 – module for an additional platform



DP1 PCB

DP1 modules increase functionality of PUE C41H indicators by possibility of adding an additional platform. It is intended to mount inside the indicator. DP1 modules require an additional gland to led in the platform cable.

27.6.1. Technical specification

Useful number of internal divisions	8 388 608
OIML class	III
Number of verification divisions	6 000
Maximal change of input signal	19mV
Maximal voltage per verification divisions	3,3 μ V
Minimal voltage per verification divisions	1 μ V
Minimal tensometer impedance	90 Ω
Maximal tensometer impedance	1200 Ω
Tensometer excitation voltage	5V
Types of tensometers	4 or 6 wires + shield

27.6.2. Colours of wires

RADWAG Designation	Colour	Designation of soldering pads on PCB's.
+INPUT	brown	+ 5V
-INPUT	green	AGND
+OUTPUT	yellow	+ IN
- OUTPUT	white	- IN
+SENSE	grey	+ REF
- SENSE	pink	- REF
EKRAN	yellow-green	(according to the rule of connecting shields)

27.6.3. Connecting additional platforms

Connecting 6-wire tensometers

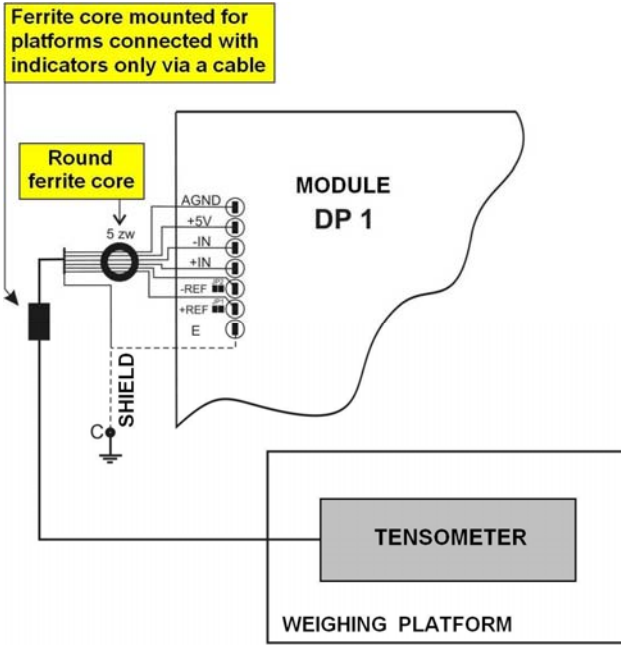

- E - tensometer cable shield
- REF+ - "SENSE +" from tensometer (JP1 not soldered)
- REF- - "SENSE -" from tensometer (JP2 not soldered)
- IN+ - "OUTPUT+" from tensometer
- IN- - "OUTPUT-" from tensometer
- +5V - "INPUT+" from tensometer
- AGND - "INPUT-" from tensometer

Connecting 4-wire tensometers

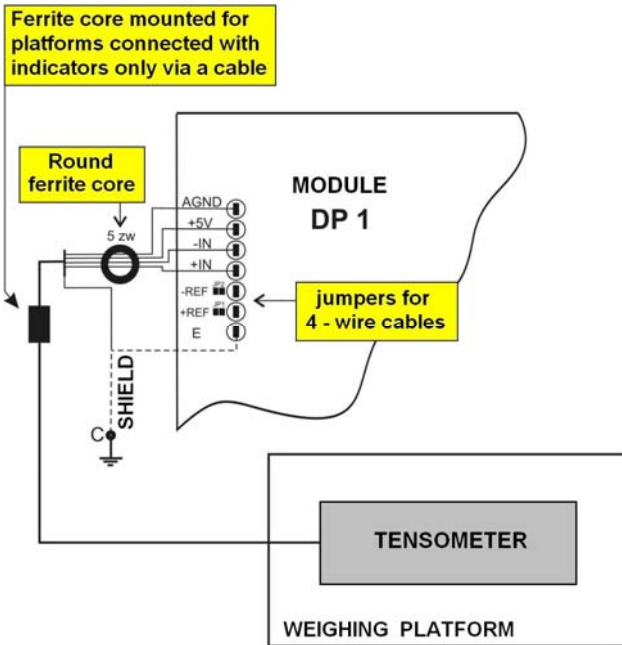

- E - tensometer cable shield
- REF+ - solder jumper JP1
- REF- - solder jumper JP2
- IN+ - "OUTPUT+" from tensometer
- IN- - "OUTPUT-" from tensometer
- +5V - "INPUT+" from tensometer
- AGND - "INPUT-" from tensometer

The rules of connecting shields from tensometer cable

For assuring appropriate operation use the description below to connect the shield of the tensometer properly. In both cases (6- and 4-wire cables) the same way rule are valid:

	platforms connected to indicators in metal housing via a cable only	platforms electrically connected to indicators' metal housings e.g. pillars, racks
Load cells without internal shield connection to the tensometer body	POINT C	E
Load cells with internal shield connection to the tensometer body	POINT C	POINT C

Point C – screwed terminal electrically connected to the metal housing of the indicator (possible using of soldering eye)

E – soldering pad on a **DP1** PCB

The way of checking connection between the shield and the tensometer body

Use an ohmmeter for this purpose.

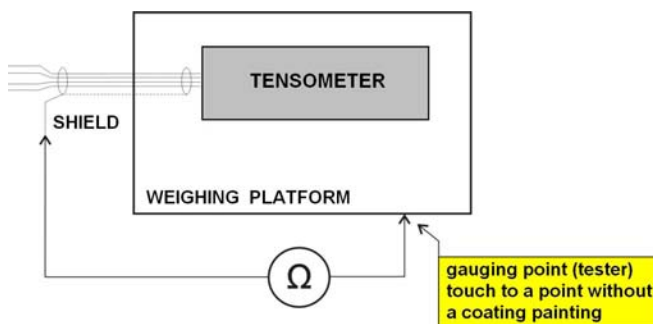

27.6.4. Installing in PUE C41H housing

DP1 modules are intended to mount inside PUE C41H housings. It is mounted to the main board to the 10-pin **J18** connector. For **DP1** module an additional gland is installed on the back wall of the housing.

1. Unplug the scale from mains;
2. Unscrew and take off the back wall of the housing;
3. Install your module in **J18** on the main board;

- During installation turn your attention to plastic columns. They should be placed one side in mounting holes in the main board and the other side in the mounted module **DP1**.

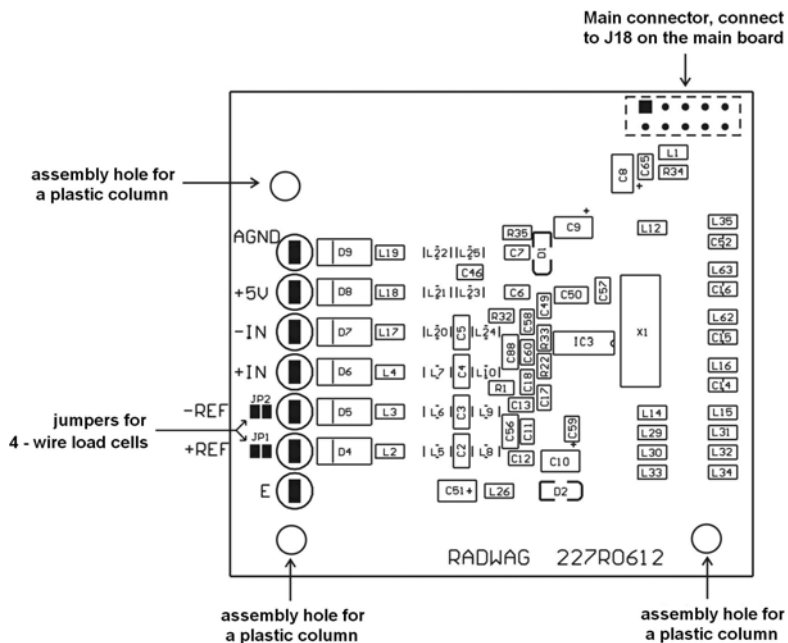

Installing DP1 module on the main board of PUE C41H

- Led a tensometer cable through the PG7 gland next to the gland of main platform;
- Put on a ferrite core on the cable (core of appropriate internal diameter);
- Turn the wires on the ferrite core (5 turns);
- Solder the wires to the pads on the DP1. **Use soldering iron (no solder guns or Rother inductive devices);**
- Fasten the cable to the housing using a band clip (to the screwed terminal on the back wall of the housing);
- Screw down the back wall.

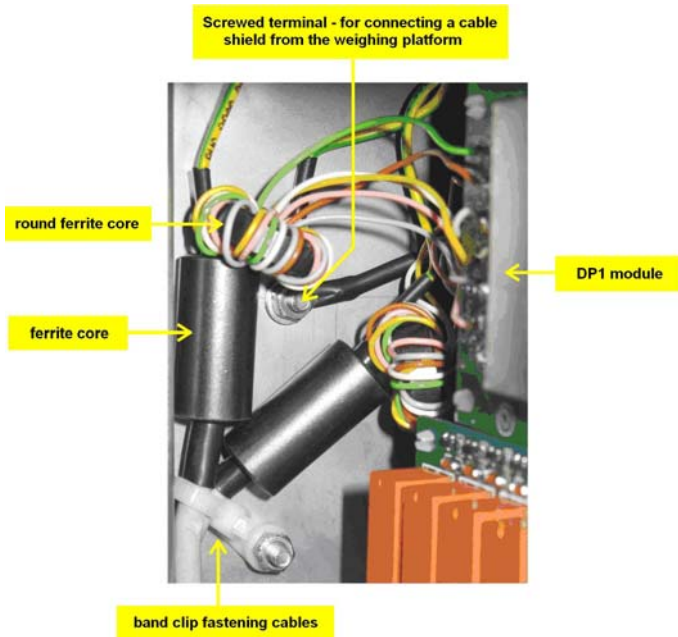

27.7. RS485 led out via RS 1D gland

A version with the **RS485** interface led out via a gland (in the standard solution RS485 is present in a socket). A 3m cable is led out through the gland.

27.7.1. Installing inside the PUE C41H housing

1. Unplug the scale from mains;
2. Unscrew and take off the back wall of the housing;
3. Unplug one of the unused glands and led out the **PT0012** cable through it;
4. Connect the **PT0012** cable to the **J20** connector (ARK type) on the main board of PUE C41H:

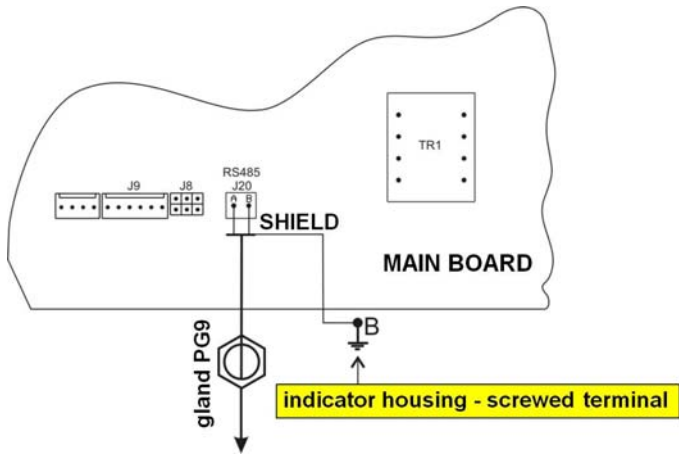

PT0012 cable connecting to the main board of PUE C41H

5. Connect the **PT0012** shield to the housing (4mm screwed terminal on the back wall)
6. The cable connect to the group of wires (unhook band clips fastening the group of wires, lay the cable and hook the band clips).
Band clips of multiple usage;
7. Screw down the back wall.

27.7.2. RS 485 - PT0012 cable drawing

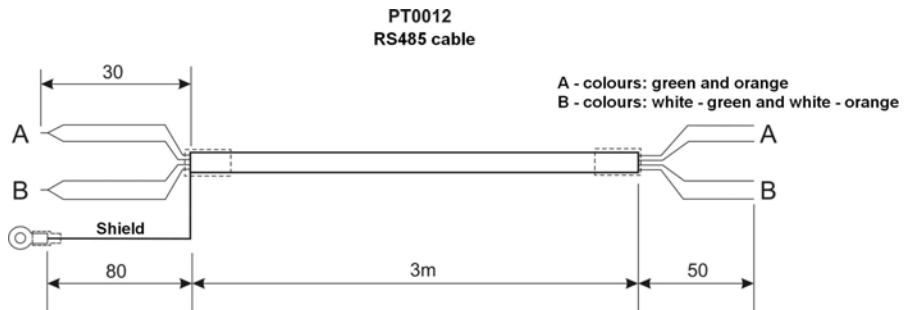

28. COMMUNICATION PROTOCOL

28.1. General information

- A. A character protocol scale-terminal has been designed for communication between RADWAG scales and external devices via RS-232 interface.
- B. It consists of commands sent from an external device to the scale and a responses from a scale.
- C. Responses are sent every time after receiving a command (reaction for any command).
- D. Using commands allows users to receive some information about the state of scale and/or influence the operation e.g.: Requesting weighing results, display control.

28.2. A set of commands for RS interfaces

Commands	Description of commands
Z	Zeroing
T	Tarring
OT	Get tare
UT	Set tare
S	Send the stable result in basic unit
SI	Send the result immediately in basic unit
SIA	Get immediate results from both platforms in basic units
SU	Send the stable result in current unit
SUI	Send the result immediately in current unit
C1	Switch on continuous transmission in basic unit
C0	Switch off continuous transmission in basic unit
CU1	Switch on continuous transmission in current unit
CU0	Switch off continuous transmission in current unit
K1	Lock the scale keyboard
K0	Unlock the scale keyboard
S1	Start dosing/filling
S0	Stop dosing/filling
DH	Set lower threshold

UH	Set upper threshold
ODH	Read lower threshold
OUH	Read upper threshold
PC	Send all implemented commands

Notice:

1. *Each command have to be terminated in CR LF;*
2. *The best Policy for communication is not sending another command until the former answer has been received.*

28.3. Respond message format

After sending a request message you can receive:

XX_A CR LF	command accepted and in progress
XX_D CR LF	command completed (appears only after XX_A)
XX_I CR LF	command comprehended but cannot be executed
XX_^ CR LF	command comprehended but time overflow error appeared
XX_v CR LF	command comprehended but the indication below the
XX_OK CR LF	Command done
ES_CR LF	Command not comprehended
XX_E CR LF	error while executing command – time limit for stable result exceeded (limit time is a descriptive parameter of the scale)

XX - command name
 _ - substitutes spaces

28.4. Command's description

28.4.1. Zeroing

Syntax **Z CR LF**

Possible answers:

Z_A CR LF - command accepted and in progress
Z_D CR LF - command completed

- Z_A CR LF** - command accepted and in progress
- Z^ CR LF** - command comprehended but zero range overflow appeared
- Z_A CR LF** - command accepted and in progress
- Z_E CR LF** - time limit for stable result exceeded
- Z_I CR LF** - command comprehended but cannot be executed

28.4.2. Tarring

Syntax: **T CR LF**

Possible answers:

- T_A CR LF** - command accepted and in progress
- T_D CR LF** - command completed
- T_A CR LF** - command accepted and in progress
- T_v CR LF** - command comprehended but tare range overflow appeared
- T_A CR LF** - command accepted and in progress
- T_E CR LF** - time limit for stable result exceeded
- T_I CR LF** - command comprehended but cannot be executed

28.4.3. Get tare value

Syntax: **OT CR LF**

Possible answers:

- OT_TARA CR LF** - command executed

Frame format:

1	2	3	4-12	13	14	15	16	17	18	19
O	T	space	tare	space	unit			space	CR	LF

- Tare** - 9 characters with decimal point justified to the right
- Unit** - 3 characters justified to the left

28.4.4. Set tare value

Syntax: **UT_TARE CR LF**, where **TARE** – tare value

Possible answers:

UT_OK CR LF - command executed

UT_I CR LF - command comprehended but cannot be executed

ES CR LF - command not recognised (possible wrong tare format)

Notice:

This protocole uses the dot character as a decimal point for separating the decimal fraction part.

28.4.5. Send the stable result in basic unit

Syntax: **S CR LF**

Possible answers:

S_A CR LF - command accepted and in progress

S_E CR LF - time limit for stable result exceeded

S_I CR LF - command comprehended but cannot be executed

S_A CR LF - command accepted and in progress

MASS FRAME - mass value in basic unit is returned

Frame format:

1	2-3	4	5	6	7-15	16	17	18	19	20	21
S	space	stability	space	sign	mass	space	unit		CR	LF	

Example:

S CR LF – computer command

S_A CR LF - command accepted and in progress

S _____ - _____ 8 . 5 _ g _ _ CR LF – command done, mass value in basic unit is returned.

28.4.6. Send the result immediately in basic unit

Syntax: **SI CR LF**

Possible answers:

SI_I CR LF - command comprehended but cannot be executed at the moment

SI_A CR LF - command accepted and in progress

MASS FRAME - mass value in basic unit is returned

Frame format:

1	2	3	4	5	6	7-15	16	17	18	19	20	21
S	I	space	stability	space	sign	mass	space	unit			CR	LF

Example:

S I CR LF – computer command

S I _ ? _ _ _ _ _ 1 8 . 5 _ k g _ CR LF - command done, mass value in basic unit is returned immediately.

28.4.7. Get immediate results from both platforms in basic units

Syntax: **SIA CR LF**

Possible answers:

SIA_I CR LF - command comprehended but cannot be executed at the moment

MASS FRAME „P1” CR LF

MASS FRAME „P2” CR LF - mass values are immediately returned from both platforms in basic units

Frame format with mass from subsequent platforms as indicator reply:

1	2	3	4	5	6	7-15	16	17	18	19	20	21
P	n	space	stability	space	sign	mass	space	unit			CR	LF

n - weighing platform number
mass - 9 characters justified to the right
unit - 3 characters justified to the left

Example:

Let us assume that both platforms are connected to indicator PUE C41H.

S I A CR LF – computer command

P 1 _ ? _ _ _ _ _ 1 1 8 . 5 _ g _ _ CR LF

P 2 _ _ _ _ _ _ _ 3 6 . 2 _ k g _ CR LF - command done, mass values from both platforms are returned in basic units

28.4.8. Send the stable result in current unit

Syntax: **SU CR LF**

Possible answers:

SU_A CR LF - command accepted and in progress

SU_E CR LF - timeout while waiting for stable results

SU_I CR LF - command comprehended but cannot be executed

SU_A CR LF - command accepted and in progress

MASS FRAME - mass value in current unit is returned

Frame format:

1	2	3	4	5	6	7-15	16	17	18	19	20	21
S	U	space	stability	space	sign	mass	space	unit			CR	LF

Example:

S U CR LF – computer command

S U _ A CR LF - command accepted and in progress

S U _ _ _ - _ _ 1 7 2 . 1 3 5 _ N _ _ CR LF - command done, mass value in current unit is returned.

28.4.9. Send the result immediately in current unit

Syntax: **SUI CR LF**

Possible answers:

SUI_I CR LF - command comprehended but cannot be executed

SUI_A CR LF - command accepted and in progress

MASS FRAME - mass value in current unit is returned immediately

Frame format:

1	2	3	4	5	6	7-15	16	17	18	19	20	21
S	U	I	stability	space	sign	mass	space	unit			CR	LF

Example:

S U I CR LF – computer command

S U I ? _ - _ _ _ 5 8 . 2 3 7 _ k g _ CR LF - command executed and mass returned

28.4.10. Switch on continuous transmission in basic unit

Syntax: **C1 CR LF**

Possible answers:

C1_I CR LF - command comprehended but cannot be executed

C1_A CR LF - command comprehended and in progress

MASS FRAME - mass value in basic unit is returned

Frame format:

1	2	3	4	5	6	7-15	16	17	18	19	20	21
S	I	space	stability	space	sign	mass	space	unit			CR	LF

28.4.11. Switch off continuous transmission in basic unit

Syntax: **C0 CR LF**

Possible answers:

- C0_I CR LF** - command comprehended but cannot be executed
- C0_A CR LF** - command comprehended and executed

28.4.12. Switch on continuous transmission in current unit

Syntax: **CU1 CR LF**

Possible answers:

- CU1_I CR LF** - command comprehended but cannot be executed
- CU1_A CR LF** - command comprehended and in progress
- MASS FRAME** - mass value in current unit is returned

Frame format:

1	2	3	4	5	6	7-15	16	17	18	19	20	21
S	U	I	stability	space	sign	mass	space	unit			CR	LF

28.4.13. Switch off continuous transmission in current unit

Syntax: **CU0 CR LF**

Possible answers:

- CU0_I CR LF** - command comprehended but cannot be executed
- CU0_A CR LF** - command comprehended and executed

28.4.14. Lock the scale keyboard

Syntax: **K1 CR LF**

Possible answers:

K1_I CR LF - command comprehended but cannot be executed

K1_OK CR LF - command executed

Caution:

This command is not remembered after restart

28.4.15. Unlock the scale keyboard

Syntax: **K0 CR LF**

Possible answers: **K0_OK CR LF** – command in progress

28.4.16. Initiating of dosing/filling

Syntax: **S1 CR LF**

Possible answers:

S1_I CR LF - command comprehended but cannot be executed

S1_OK CR LF - command in progress

28.4.17. Stop of dosing/filling

Syntax: **S0 CR LF**

Possible answers:

S0_I CR LF - command comprehended but cannot be executed

S0_OK CR LF - command in progress

28.4.18. Set lower threshold

Syntax: **DH_XXXXX CR LF**, where: **XXXXX** – mass format

Possible answers:

DH_OK CR LF - command executed

ES CR LF - command not comprehended (wrong mass format)

28.4.19. Set upper threshold

Syntax: **UH_XXXXX CR LF**, where: **XXXXX** – mass format

Possible answers:

UH_OK CR LF - command executed

ES CR LF - command not comprehended (wrong mass format)

28.4.20. Read lower threshold

Syntax: **ODH CR LF**

Possible answers: **DH_MASA CR LF** - command executed

Frame format:

1	2	3	4-12	13	14	15	16	17	18	19
D	H	space	mass	space	unit		space	CR	LF	

Mass - 9 characters justified to the right

Unit - 3 characters justified to the left

28.4.21. Read upper threshold

Syntax: **OUH CR LF**

Possible answers: **UH_MASA CR LF** - command executed

Frame format:

1	2	3	4-12	13	14	15	16	17	18	19
U	H	space	mass	space	unit		space	CR	LF	

- Mass** - 9 characters justified to the right
- Unit** - 3 characters justified to the left

28.4.22. Send all implemented commands

Syntax: **PC CR LF**

Possible answers:

PC_A "Z,T,S,SI,SU,SUI,C1,C0,CU1,CU0,PC,K1,K0,DH,UH,ODH,OUH,S1,S0,OT,UT" – command executed, the indicator have sent all the implemented commands.

28.5. Manual printouts / automatic printouts

Users can general manual or automatic printouts from the scale.

- Manual printouts can be performed after loading the pan and stabilizing indication by pressing .
- Automatic printouts can be performed only after loading the pan and stabilizing indication.

Notice:

If a scale is verified printouts of immediate values are blocked.

Format frame:

1	2	3	4 -12	13	14	15	16	17	18
stability	space	sign	mass	space	unit			CR	LF

- Stability character** [space] if stable
[?] if not stable
[^] if an indication over the range
[v] if fan indication below the range
- sign** [space] for positive values or
[-] for negative values
- mass** 9 characters justified to the right
- unit** 3 characters justified to the left
- command** 3 characters justified to the left

Example 1:

______1 8 3 2 . 0 _ g _ _ CR LF – the printout generated from the scale after pressing ENTER/PRINT.

Example 2:

? _ - _____ 2 . 2 3 7 _ l b _ CR LF - the printout generated from the scale after pressing ENTER/PRINT.

Example 3:

^ _____ 0 . 0 0 0 _ k g _ CR LF - the printout generated from the scale after pressing ENTER/PRINT.

28.6. Continuous transmission

The indicator can work in a continuous transmission mode. It can be switched on or off in parameters or using RS232 commands.

Frame format sent by the indicator when continuous transmission is set:

1	2	3	4 -12	13	14	15	16	17	18
stability	space	sign	mass	space	unit			CR	LF

- Stability character** [space] if stable
[?] if not stable
[^] if an indication over the range
[v] if an indication below the range
- sign** [space] for positive values or
[-] for negative values
- mass** 9 characters justified to the right
- unit** 3 characters justified to the left
- command** 3 characters justified to the left

28.7. Configuring printouts

If some information included are redundant or not sufficient and there is a necessity of changes you can design a non-standard printout. There is possible to create up to four standard printouts (see the chapter. 17).

29. ERROR MESSAGES

ERROR "XXX" ESC – RETURN TO PREVIOUS SETTING (where: XXX – parameter name) – confirmed with **ENTER** of a wrong value in the user's menu,

- Err2** - Value beyond the zero range,
- Err3** - Value beyond the tare range,
- Err4** - Calibration mass or start mass adjustment error
($\pm 1\%$ for weight, $\pm 10\%$ for start mass),
- Err5** - Mass of a single piece lower than the 0.1 of scale division,
- Err6** - Mass of all pcs (declared as standard) lower than one division,
- Err8** - Tarring / zeroing operation time exceeded,
- NULL** - Zero value from the AD converter,
- FULL2** - Measurement range overflow,
- HI** - Display range overflow,
- LH** - Start mass error, the mass on the weighing platform is beyond the acceptable range ± 20 of start mass

30. TROUBLE SHOOTING

Problem	Cause	Solution
Scale switches off automatically	„t1” parameter set to „YES” (Power save)	In <P9 OTHERS> change <P9.3 AUTO SWITCH.> to „NO”
„LH” appears on the display	Weight pan not empty when switching on	Unload the pan. Indication returns to zero

31. TECHNICAL PARAMETERS

31.1. Scales for +/- control

Scale type:	WPW 1,5/T1	WPW 3/T1	WPW 6/T2	WPW 15/T2
Max capacity	1,5kg	3kg	6kg	15kg
Readability	0,5g	1g	2g	5g
Tare range	-1,5kg	-3kg	-6kg	-15kg
Pan size	200 × 150mm		250 × 300mm	
Work temperature	- 10°C to +40°C			
Interfaces	RS 232, RS 485			
Ingress protection rating	IP 66/67			
Power supply	85-265V AC 50Hz and internal accumulator 6V			
Battery operation time	Up to 9 h			
Display	LCD with backlight			

Scale type:	WPW 15/T3	WPW 30/T3	WPW 60/T3
Max capacity	15kg	30kg	60kg
Readability	5g	10g	20g
Tare range	-15kg	-30kg	-60kg
Pan size	410 × 410mm		
Work temperature	- 10°C to +40°C		
Interfaces	RS 232, RS 485		
Ingress protection rating	IP 66/67		
Power supply	85-265V AC 50Hz and internal accumulator 6V		
Battery operation time	Up to 9 h		
Display	LCD with backlight		

31.2. Multifunctional scales of WPW series

Scale type:	WPW 6 C1/K	WPW 15 C1/K	WPW 30 C1/K	WPW 60 C2/K
Max capacity	6kg	15kg	30kg	60kg
Readability	2g	5g	10g	20g
Tare range	-6kg	-15kg	-30kg	-60kg
Pan size	290 × 360mm			400 × 500mm
Work temperature	- 10°C to +40°C			
Interfaces	RS 232, RS 485			
Ingress protection rating	IP 66/67			
Power supply	85-265V AC 50Hz and internal accumulator 6V			
Battery operation time	Up to 9 h			
Display	LCD with backlight			

Scale type:	WPW 150 C2/K	WPW 300 C2/K	WPW 150 C3/K	WPW 300 C3/K
Max capacity	150kg	300kg	150kg	300kg
Readability	50g	100g	50g	100g
Tare range	-150kg	-300kg	-150kg	-300kg
Pan size	400 × 500mm		500 × 700mm	
Work temperature	- 10°C to +40°C			
Interfaces	RS 232, RS 485			
Ingress protection rating	IP 66/67			
Power supply	85-265V AC 50Hz and internal accumulator 6V			
Battery operation time	Up to 9 h			
Display	LCD with backlight			

31.3. Multifunctional scales of WPW/H series

Scale type:	WPW 3 H1/K	WPW 6 H2/K	WPW 15 H2/K	WPW 15 H3/K	WPW 30 H3/K
Max capacity	3kg	6kg	15kg	15kg	30kg
Readability	1g	2g	5g	5g	10g
Tare range	-3kg	-6kg	-15kg	-15kg	-30kg
Pan size	150×200mm	250 × 300mm		410 × 410mm	
Work temperature	- 10°C to +40°C				
Interfaces	RS 232, RS 485				
Ingress protection rating	IP 66/67				
Power supply	85-265V AC 50Hz and internal accumulator 6V				
Battery operation time	Up to 9 h				
Display	LCD with backlight				

Scale type:	WPW 60 H3/K	WPW 150 H3/K	WPW 60 H4/K	WPW 150 H4/K
Max capacity	60kg	150kg	60kg	150kg
Readability	20g	50g	20g	50g
Tare range	-60kg	-150kg	-60kg	-150kg
Pan size	410 × 410mm		500 × 500mm	
Work temperature	- 10°C to +40°C			
Interfaces	RS 232, RS 485			
Ingress protection rating	IP 66/67			
Power supply	85-265V AC 50Hz and internal accumulator 6V			
Battery operation time	Up to 9 h			
Display	LCD with backlight			

Scale type:	WPW 150 H5/K	WPW 300 H5/K	WPW 60 H5/K	WPW 150 H6/K	WPW 300 H6/K
Max capacity	150kg	300kg	60kg	150kg	300kg
Readability	50g	100g	20g	50g	100g
Tare range	-150kg	-300kg	-60kg	-150kg	-300kg
Pan size	600 × 600mm			800 × 800mm	
Work temperature	- 10°C to +40°C				
Interfaces	RS 232, RS 485				
Ingress protection rating	IP 66/67				
Power supply	85-265V AC 50Hz and internal accumulator 6V				
Battery operation time	Up to 9 h				
Display	LCD with backlight				

31.4. Dosing scales of WPW/D series

Scale type:	WPW/D 6 C1/K	WPW/D 15 C1/K	WPW/D 30 C1/K	WPW/D 60 C2/K
Max capacity	6kg	15kg	30kg	60kg
Readability	2g	5g	10g	20g
Tare range	-6kg	-15kg	-30kg	-60kg
Pan size	290 × 360mm			400 × 500mm
Work temperature	- 10°C to +40°C			
Interfaces	RS 232, RS 485			
Ingress protection rating	IP 66/67			
Power supply	85-265V AC 50Hz and internal accumulator 6V			
Battery operation time	Up to 9 h			
Display	LCD with backlight			

Scale type:	WPW/D 150 C2/K	WPW/D 300 C2/K	WPW/D 150 C3/K	WPW/D 300 C3/K
Max capacity	150kg	300kg	150kg	300kg
Readability	50g	100g	50g	100g
Tare range	-150kg	-300kg	-150kg	-300kg
Pan size	400 × 500mm		500 × 700mm	
Work temperature	- 10°C to +40°C			
interfaces	RS 232, RS 485			
Ingress protection rating	IP 66/67			
Power supply	85-265V AC 50Hz and internal accumulator 6V			
Battery operation time	Up to 9 h			
Display	LCD with backlight			

31.5. Dosing scales of WPW/D/H series

Scale type:	WPW/D 3 H1/K	WPW/D 6 H2/K	WPW/D 15 H2/K	WPW/D 15 H3/K	WPW/D 30 H3/K
Max capacity	3kg	6kg	15kg	15kg	30kg
Readability	1g	2g	5g	5g	10g
Tare range	-3kg	-6kg	-15kg	-15kg	-30kg
Pan size	150 × 200mm	250 × 300mm		410 × 410mm	
Work temperature	- 10°C to +40°C				
interfaces	RS 232, RS 485				
Ingress protection rating	IP 66/67				
Power supply	85-265V AC 50Hz and internal accumulator 6V				
Battery operation time	Up to 9 h				
Display	LCD with backlight				

Scale type:	WPW/D 60 H3/K	WPW/D 150 H3/K	WPW/D 60 H4/K	WPW/D 150 H4/K
Max capacity	60kg	150kg	60kg	150kg
Readability	20g	50g	20g	50g
Tare range	-60kg	-150kg	-60kg	-150kg
Pan size	410 × 410mm		500 × 500mm	
Work temperature	- 10°C to +40°C			
interfaces	RS 232, RS 485			
Ingress protection rating	IP 66/67			
Power supply	85-265V AC 50Hz and internal accumulator 6V			
Battery operation time	Up to 9 h			
Display	LCD with backlight			

Scale type:	WPW/D 150 H5/K	WPW/D 300 H5/K	WPW/D 60 H5/K	WPW/D 150 H6/K	WPW/D 300 H6/K
Max capacity	150kg	300kg	60kg	150kg	300kg
Readability	50g	100g	20g	50g	100g
Tare range	-150kg	-300kg	-60kg	-150kg	-300kg
Pan size	600 × 600mm			800 × 800mm	
Work temperature	- 10°C to +40°C				
interfaces	RS 232, RS 485				
Ingress protection rating	IP 66/67				
Power supply	85-265V AC 50Hz and internal accumulator 6V				
Battery operation time	Up to 9 h				
Display	LCD with backlight				

32. APPENDIX

32.1. Communication with barcode scanners

1. For communication with barcode scanners RADWAG scales use RS232 interfaces and simplex transmission (one direction) without handshaking. Only two wires are required for assuring such a transmission. Used scanners should be equipped in such interface with disabled both hardware and software handshaking.
2. Both scales and scanners have the possibility of setting of transmission parameters. Both devices are required to have the same parameters set : baud rate, number of data bits, parity control, stop bits. e.g. 9600,8,N,1 – baud rate 9600 bit/s , data 8-bits, no parity control, 1 stop bit.
3. Barcode scanners can send additional information apart from the expected barcode e.g. symbology (type of barcode). It is advisable to disable such information because RADWAG devices and software do not use it.
4. Some RADWAG systems can omit unnecessary information by using parameters that mark the beginning and the length of the code required to analyse.
5. A special protocol is required in order the code be received by RADWAG equipment. It is required to program an appropriate *prefix and suffix*. Prefix – one byte 01 hexadecimally, suffix one byte 0D hexadecimally.
6. Most barcode scanners allow to enable/disable different symbologies (barcode types).
7. Programming of scanners is usually performed by reading special barcodes or by using an external software tool.
8. Scanners marketed together with RADWAG systems are always configured according to the rules above.

Barcode with required prefix and suffix in hexadecimal format	Barcode without required –fixes in ASCII format	Code type
01 30 30 32 31 30 31 32 36 0D	00210126	EAN-8
01 30 31 32 33 34 35 36 37 38 39 0D	0123456789	2 of 5
01 43 4F 44 45 20 33 39 20 54 45 53 54 0D	CODE 39 TEST	CODE 39
01 31 31 30 31 32 33 34 35 36 37 38 39 31 0D	1101234567891	EAN-13
01 43 6F 64 65 20 31 32 38 20 54 65 73 74 0D	CODE 128 Test	CODE 128

32.2. Cooperation with „EDYTOR WPW” – PC software tool

Standard WPW scales can be supervised by the accompanied program **EDYTOR WPW**, that can work as an additional display on the monitor and:

- Edit and change user parameters (filters, date/time, backlight, configuring I/O, port parameters etc.),
- Create, upload, edit, download databases,
- Receive and save printouts in text files,
- Define the bottom line,
- Define non-standard printouts.

32.2.1. Main window

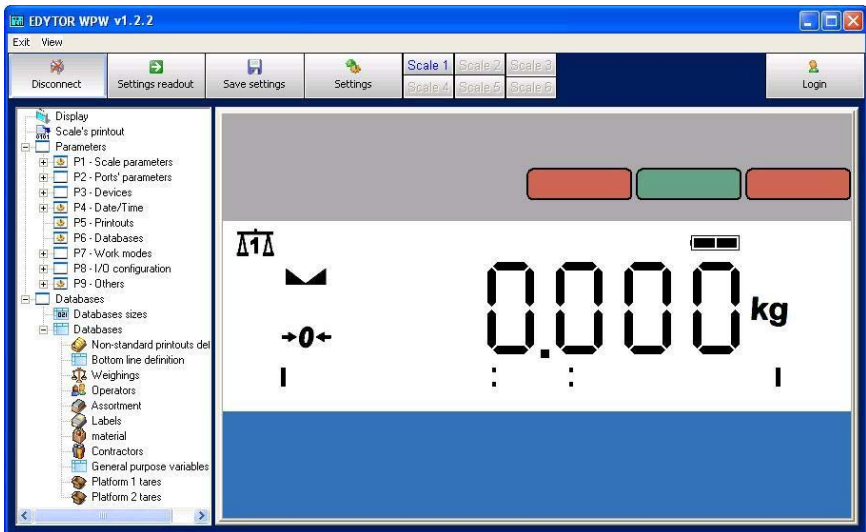

Caution:



The installation file of **EDYTOR WPW** is accessible on RADWAG website www.radwag.com. In Products /Measuring indicators / PUE C41H.

32.2.2. Setting RS232 parameters

On order to establish the connection with **EDYTOR WPW** through RS232 interface follow the remarks below:

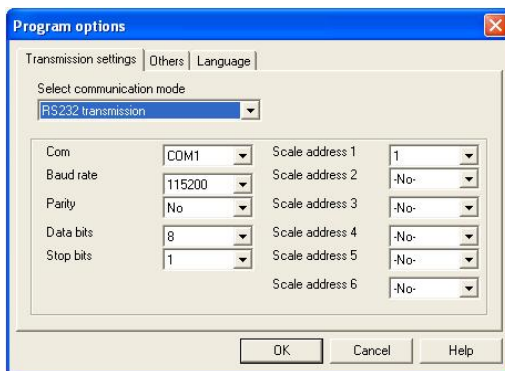
- Run **EDYTOR WPW**,
- Connect the scale to a computer using cable PT0020 (see ch. 25),
- Set the port for communication with a computer – parameter **<P3.1.1 COMP. PORT>** set to **RS232 (1)** (see ch. 15.1.1),
- Set transmission parameters:
 - submenu **<P2.2 RS232 (1)>** (see ch. 14.1.3),
- Click on the button „**Settings**” to show the window below:



- In the overlap **<Transmission settings>**:
 - Set the communication mode as „**RS232 transmission**”,
 - Select an appropriate com number,
 - Configure the selected port (baud rate, parity, data bits, stop bits),
- Confirm the changes by clicking ,
- Rerun the program,
- Press the „**Connect**” button,
- The appropriate communication with scales is signalled by pictogram  in the left part of the display,
- Transmission problems are signalled by the message window:

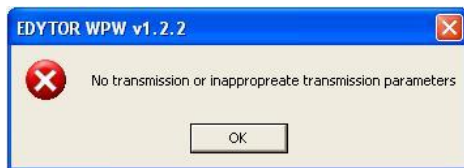

32.2.3. Setting Ethernet parameters

On order to establish the connection with **EDYTOR WPW** through Ethernet interface follow the remarks below:

- Power up the scale and run the **EDYTOR WPW** program,
- Connect the scale to a computer/switch using a PT0017 or PT0014 cable (depending on the Ethernet module on board – see ch. 27.1.2),
- Set the port for communication with a computer – parameter **<P3.1.1 COMP. PORT>** set to **Ethernet** (see ch. 15.1.1),
- Set parameters from the **<P2.4 ETHERNET>** group (see ch. 14.2):
 - Parameter **<P2.4.1 WORK MODE>** should be set to **SERVER**,
 - Parameters **<P2.4.2 IP ADDRESS>**, **<P2.4.3 SUBNET MASK>**, **<P2.4.4 GATEWAY>** should be set according to the network supervisor directions,
 - **<P2.4.5 LOCAL PORT>** set the same as in the computer program (in networks some ports can be taken),
 - Parameter **<P2.4.8 TIMEOUT>** set to **0** in order to prevent breaking connection.
- Press the „**Settings**” button:

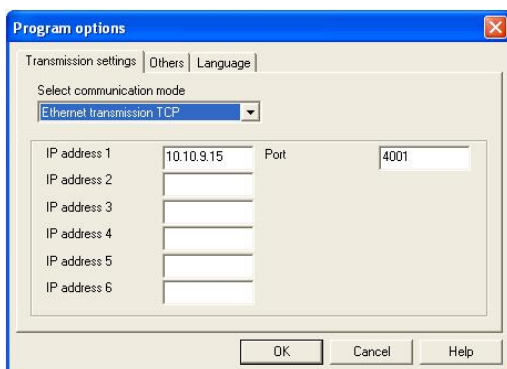

- In the overlap **<Transmission setting>**:
 - Set the communication type „**Ethernet Transmission TCP**”,
 - „**IP address 1**” the same as **<P2.4.2 IP ADDRESS>** in the scale,
 - „**Port**”/”**Com**” the same as **<P2.4.5 LOCAL PORT>** in the scale,
- Confirm the changes by clicking ,
- Rerun the program,
- Press the „**Connect**” button,
- The appropriate communication with scales is signalled by pictogram  in the left part of the display,
- Transmission problems are signalled by the message window:

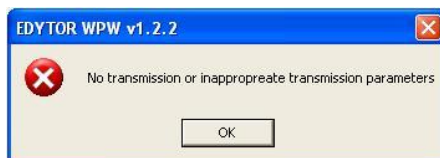

32.3. Example of dosing application

A standard WPW scale (3 inputs / 3 outputs in connector) have a task to perform a two-threshold dosing (bulk/precise dosing) in the manual mode with external buttons START and STOP process.

Caution:

*Simple dosing systems can use one of three different methods: **1** – manual mode, **2** – automatic mode, **3** – negative dosing (see ch.. 24.8.1).*

Procedure:

1. According to ch.11.2.:

- Enter the group of parameters **<P8.1 EXTERNAL BUTTONS>** and configure the buttons according to the table below:

TARE B.	NO
PRINT B.	NO
ZERO B.	NO
START B.	IN1
STOP B.	IN2
EXTERN. START	NO

HOLD B.	NO
CHUTE ENABLE	NO

- Enter the submenu **<P8.2 OUTPUT CONF.>** and configure outputs according to the table below:

MIN	NO
OK	NO
MAX	NO
STABLE	NO
THRESHOLD 1	OUT1
THRESHOLD 2	OUT2
CHUTE	OUT3

2. Return to weighing according to ch.11.3.
3. Connect the cable Scale - I/O (see ch. 25) and then install external buttons START, STOP (terminal inputs) and subsequent devices to the terminal outputs according to the drawings below:

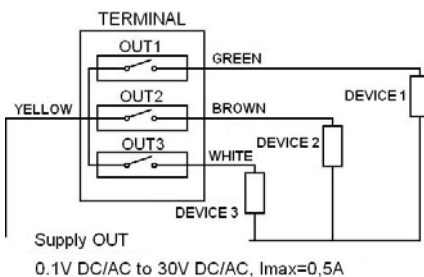
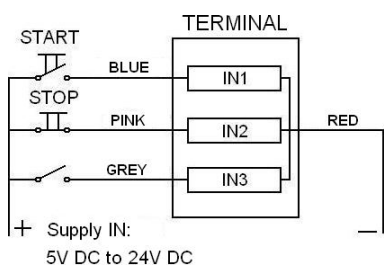

4. Enter the **DOSING** operating mode according to ch. 24.8.6,
5. Press **2** (ABC) to enter thresholds setting:
 - **MIN** – mass value over which the bulk dosing changes to the precise dosing ,
 - **MAX** – mass value over which dosing is completed and CHUTE starts.
6. Before you start dosing unload the pen (container, silo) or tare the scale pressing **T**.
7. Start the process by pressing the external **START** button, pictogram starts to blink, and threshold 1, **THR 1** bulk dosing, is performed.

Caution:

The way how outputs operates in thresholds is set in **<P7.4.4 OUTPUT MOD.>**(see ch. 24.8.4). For this example this parameter is set to **1_2**.

8. After the **MIN** value, equivalent to **THR 1**, is overpassed the bulk dosing is switched off and precise dosing is switched on **THR 2**.
9. After the **MAX** value, equivalent to **THR 2**, is overpassed the precise dosing is switched off and chute can be performed .
10. When the indication reaches the value lower than **-LO-** (see ch. 13.4) program starts to count down the time set in **<P7.4.3 CHUTE TIME>** (see ch. 24.8.3) and then completes the dosing process with the message **<DOSING END>** in the bottom line.

Caution:

You can stop dosing time by pressing the external **STOP** button.

32.4. Example of designing non-standard printouts

„RADWAG”

DATE:

TIME:

MASS:

SIGNATURE:.....

After entering the non-standard printouts edition (see ch. 17.5.) we design the printout:

```
„RADWAG”\C\TDATE : % 0 0 2 \C\T TIME: % 0 0 3 \C\T M A  
S S : % 0 0 0 \C\C\T\T SIGNATURE : . . . . . \C\0
```

32.5. Example of creating a complex report

Let us assume that a user wants to design a complex report including weighings for subsequent products. The user wants to include the company name (header) and simple statistics for weighings of subsequent products as the number and sum of weighings (footer).

Procedure of designing the report pattern:

1. Run program **EDYTOR WPW** and initiate communication with the scale according to ch. 32.2 of this manual,
2. Open database „labels” at: Databases/Databases/Labels. Press  to upload data from the scale:

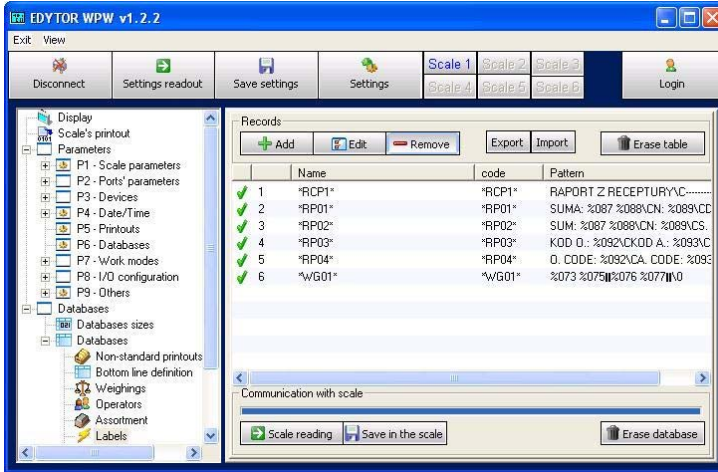

3. Edit one of the existing report patterns (*RP01*, *RP02*, *RP03* or *RP04*):

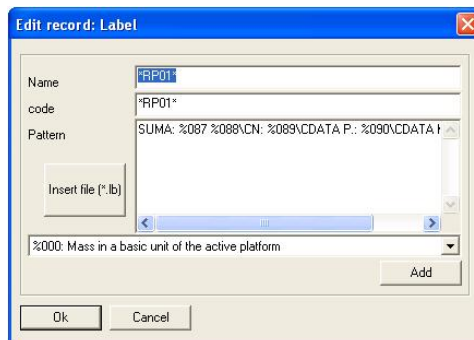

4. Enter the new report pattern:

RADWAG WAGI ELEKTRONICZNE

Product: %129

Weighings:

%130%089. %073 %075 %076 %077

%130-----

Number of weighings: %089

Sum of weighings: %087

\0

Description of applied variables:

RADWAG WAGI ELEKTRONICZNE – company name (header)

- %129 - The name of present record for the complex report
- %130 - Marking the line for beginning printing weighings in the complex report. (variable have to be placed twice to create the beginning and the end of the loop for printing weighings and separates weighings from other report parts)
- %073 - Net mass of a weighing from the database
- %075 - Weighing unit for printing weighings from the database
- %076 - Dates of weighings for printing weighings from the database
- %077 - Times of weighings for printing weighings from the database
- %089 - Number of weighings (footer)
- %087 - Sum of weighins (footer)
- \0 - Termination of the report (necessary)

How to print the report:

- Enter the report edition according to ch. 19.1 of this manual,
- According to ch. 19.2 of this manual:
 - Set the product code filter to **<NON-ZERO>**,
 - Go to **<PRINT REPORT>** and choose the report pattern you have modified,
 - Press  and then the report is being printed on the connected printer:

RADWAG WAGI ELEKTRONICZNE					
Assortment: Gammos					
Weighing					
1.	0.190	kg	2009-05-22	7:49:47	
2.	0.190	kg	2009-05-22	7:49:48	
3.	0.190	kg	2009-05-22	7:49:48	
4.	0.190	kg	2009-05-22	7:49:49	
5.	0.190	kg	2009-05-22	7:49:49	
6.	0.190	kg	2009-05-22	7:49:50	
7.	0.190	kg	2009-05-22	7:49:50	
8.	0.000	kg	2009-05-22	12:50:38	
9.	0.000	kg	2009-05-27	8:20:14	
10.	0.000	kg	2009-05-27	8:26:27	
11.	0.000	kg	2009-05-27	8:27:07	
Number of weighings: 11					
Sum of weighings: 1.330					
RADWAG WAGI ELEKTRONICZNE					
Assortment: Bacon					
Weighing					
1.	1.501	kg	2009-05-22	11:13:45	
2.	1.501	kg	2009-05-22	11:13:45	
3.	1.501	kg	2009-05-22	11:13:46	
4.	1.501	kg	2009-05-22	11:13:46	
5.	1.501	kg	2009-05-22	11:13:47	
6.	1.501	kg	2009-05-22	11:13:47	
7.	1.501	kg	2009-05-22	11:13:48	
8.	1.501	kg	2009-05-22	11:13:49	
Number of weighings: 8					
Sum of weighings: 12.008					

32.6. Examples of surge protections

- Connection diagram of dosing indicators outputs with protection for DC:

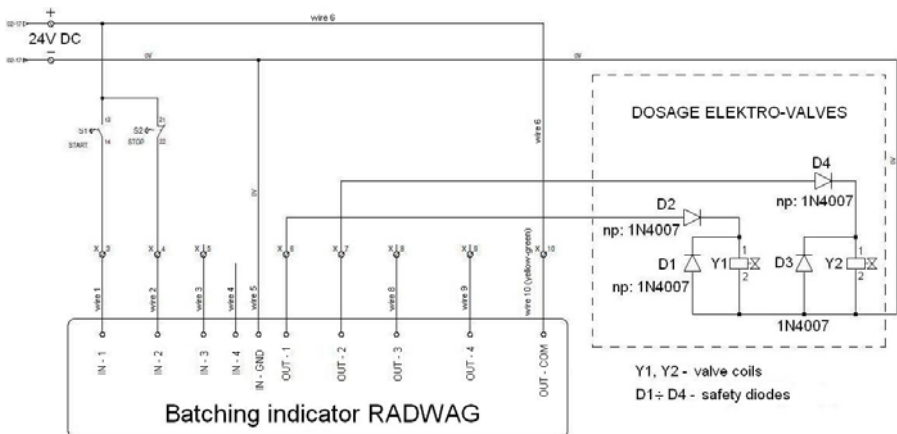

- Connection diagram of dosing indicators outputs with protection for AC:

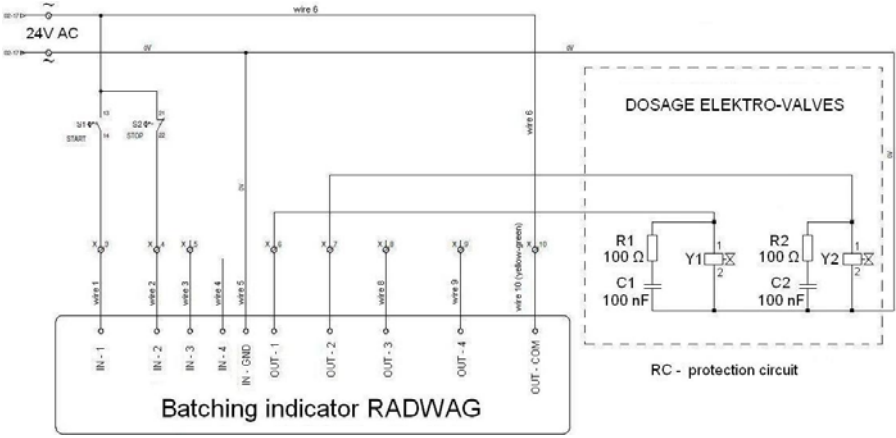

MANUFACTURER
OF ELECTRONIC WEIGHING INSTRUMENTS



PRODUCENT WAG ELEKTRONICZNYCH „RADWAG”
26 – 600 Radom, Bracka 28 Street
POLAND

Phone +48 48 38 48 800, phone/fax. + 48 48 385 00 10
Selling Department + 48 48 366 80 06

www.radwag.com



DIN EN ISO 9001:2000
CERTIFICATE NO 71 100 C206