

WPT

SCALES FOR MEAT INDUSTRY

Ramp sales

Livestock scales

Overhead scales

Waterproof scales

USER MANUAL

ITKU-21-02-08-16-EN



 **RADWAG BALANCES AND SCALES**
ADVANCED WEIGHING TECHNOLOGIES

AUGUST 2016

TABLE OF CONTENTS

1. INTENDED USE	5
2. PRECAUTIONS	6
2.1. Maintenance	6
2.2. Accumulator / battery pack	6
2.3. Operation in a strong electrostatic field.....	7
2.4. Scale washing	7
3. WARRANTY CONDITIONS	9
4. MAIN DIMENSIONS	10
4.1. Ramp scales	10
4.2. Livestock scales.....	10
4.3. Waterproof scales of WPT/H series	12
4.4. Waterproof scales of WPT/HR series.....	13
5. ASSEMBLY AND LEVELLING	13
5.1. Assembly of scales	13
5.2. Levelling the scale	16
6. GETTING STARTED	16
7. KEYPAD	17
8. KEYS' FUNCTIONS	17
9. INSCRIPTIONS ON THE DISPLAY	18
10. USER MENU	19
10.1. Submenus.....	19
10.2. Browsing user menu.....	20
10.2.1. Keypad.....	20
10.2.2. Return to the weighing mode.....	20
11. WEIGHING	21
11.1. Tarring	23
11.2. Inscribing tare value.....	23
11.3. Zeroing.....	24
11.4. Weighings in two ranges	24
11.5. Selection of basic weight unit	25
11.6. Temporarily selected unit.....	26
12. MAIN PARAMETERS	27
12.1. Setting a filtering level.....	27
12.2. Median filter	28
12.3. Autozero function	29
12.4. Tare function.....	30
13. RS 232 PARAMETERS	31
13.1. Printout type.....	31
13.2. Minimal mass threshold.....	32
13.3. Baud rate	33
13.4. Serial transmission parameters	34
14. OTHER PARAMETERS	35
14.1. Backlight function	35
14.1.1. Backlight for supplying from mains.....	35
14.1.2. Backlight for supplying from batteries.....	36
14.2. "Beep" signal – after pressing a key	37
14.3. Automatic switch-off.....	37
14.4. Battery voltage level check	38
14.4.1. Checking the batteries	39
14.4.2. Battery discharge pictogram	39
14.4.3. Accumulator charging option	40
15. WORK MODES	41
15.1. Setting accessibility of operation modes.....	41
15.2. Selecting quantity of operation modes.....	42
15.3. Counting pieces of the same mass	43
15.4. +/- control referring to the inscribed standard mass	45
15.5. Control of % deviation referring to the inscribed standard mass	47

15.5.1. Standard mass determined by its weighing.....	47
15.5.2. Mass of standard inscribed to scale memory	48
15.6. Automatic tare.....	49
15.7. Measurement max force on the pan – latch	50
15.8. Totalizing	50
15.8.1. Enabling the work mode	51
15.8.2. Totalizing procedure	51
15.8.3. Memory of the last value of sum of weighed goods.....	52
15.8.4. Return to weighing.....	53
15.9. Weighing animals	54
15.10. Tare memory.....	55
15.10.1. Entering the tare value to the scale memory.....	55
15.10.2. Selecting a tare value from the memory.....	57
16. USER CALIBRATION.....	58
16.1. Calibration.....	58
16.2. Start mass adjustment.....	60
17. COOPERATION WITH PRINTER.....	61
18. COOPERATION WITH COMPUTER.....	62
19. COMMUNICATION PROTOCOL.....	63
19.1. General information	63
19.2. A set of commands for RS interfaces	63
19.3. Respond message format	64
19.4. Command's description	64
19.4.1. Zeroing.....	64
19.4.2. Tarring	65
19.4.3. Get tare value	65
19.4.4. Set tare value.....	65
19.4.5. Send the stable result in basic unit.....	66
19.4.6. Send the result immediately in basic unit	66
19.4.7. Send the stable result in current unit	67
19.4.8. Send the result immediately in current unit	67
19.4.9. Switch on continuous transmission in basic unit	68
19.4.10. Switch off continuous transmission in basic unit	68
19.4.11. Switch on continuous transmission in current unit	69
19.4.12. Switch off continuous transmission in current unit	69
19.4.13. Lock the scale keyboard.....	69
19.4.14. Unlock the scale keyboard	70
19.4.15. Give serial number	70
19.4.16. Send all implemented commands.....	70
19.5. Manual printouts / automatic printouts.....	70
19.6. Continuous transmission	71
19.7. Configuring printouts.....	72
20. ERROR COMMANDS.....	73
21. TROUBLE SHOOTING.....	73
22. ADDITIONAL EQUIPMENT.....	74

1. INTENDED USE

Scales are designed for fast and precise measurements of weighed loads masses and direct commercial settlements. Tarring in full weighing range enables to determine net mass of weighed loads.

Functions:

- backlight of display
- level of filtration
- autozero function
- setting baud rate of transmission
- continuous data transmission for RS 232
- automatic operation for RS 232
- designed printouts
- designation minimum mass for function operating
- counting pieces
- +/- mass control
- percentage deviation from standard mass
- latch of maximum scale indication
- automatic tare
- memory of tare
- Memory of 9 tare values
- inscribing tare value
- automatic scale switch-off
- user calibration
- Totalizing
- Weighing animals

User functions may have attribute of accessibility. For this reason it is possible to adjust scale to individual needs to provide access to only these functions which are currently needed. Attribute determination accessible / inaccessible is possible in user menu and described in further part of manual.

2. PRECAUTIONS

2.1. Maintenance

- A. Please, read carefully this user manual before and use the device according to its intended use.
- B. Devices that are to be withdrawn from usage should be sent back to the producer or in case of own utilization do it according to the law.

2.2. Accumulator / battery pack

Scales equipped with **PUE C/31H** and **PUE C/31H/Z** weighing indicators (stainless steel housing) are devices designed to be supplied from **SLA** accumulators (*Sealed lead acid type*) **6V** o and capacity **3 to 4Ah** charged while connected to mains without stopping operation.

The device connected to mains intelligently monitors the battery state and charges it if possible. After sudden lack of power supply from the mains the device automatically switches to accumulator without breaking operation.



In case of an elongated storage period in low temperatures, it is not allowed the full discharge of the accompanied batteries.



A worn out accumulator can be exchanged to a new one by the authorized service of the manufacturer.



The equipment including accumulators does not belong to your regular household waste. The European legislation requires that electric and electronic equipment be collected and disposed separately from other communal waste with the aim of being recycled.

Notice:

Some symbols on accumulators identify harmful elements/compounds:

Pb = lead,

Cd = cadmium,

Hg = mercury.

2.3. Operation in a strong electrostatic field

If the device is about to operate in a strong electrostatic field (e.g. printing houses etc.) it should be connected to the earthing. Connect it to the clamp terminal signed \perp .

2.4. Scale washing

Weighing platforms are made of stainless steel (according to standards PN-0H18N9, EN-1.4301, AISI-304) and silicon elements.

There is an exception, zinc coated overhead scales and painted livestock scales made of mild constructional steel with aluminium cover plate on the platform, polyester overlays and stainless steel or polyamide glands.

Caution:

Washing and disinfection agents should be matched to the scale.

Platforms of ramp and livestock scales as well as load-bearing structures and weighing tracks of overhead scales can be washed with jet of water (temp. up to +80°C) with an appropriate washing agent. Washing measuring indicators/weighing terminals with the jet of hot water is not allowed.

Caution:

It is advisable to cover measuring indicators/weighing terminals while washing their surrounding with the jet of water.

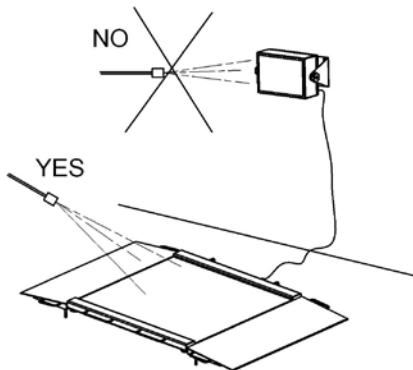

To wash waterproof platform scales and indicators/terminals neither jet of water nor hot water shall be used, in order not to damage the silicon gaiter that covers the load cell inside the platform and the overlay or glands in the indicator/terminal. To wash pans of platform scales they should be taken off first. Then they can be washed either with the jet of water or by immersion.

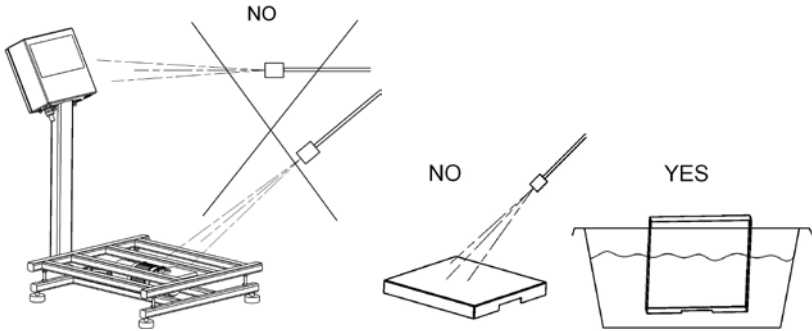

Type:		Water with detergent	Jet of water	Hot water –max 80°C
Ramp scales	Platforms with tracks	yes	yes	yes
	Indicator/terminal	yes	no	no
Livestock scales	Platform with railing	yes	yes	yes
	Indicator/terminal	yes	no	no
Overhead scales	Load bearing structure with the load cell	yes	yes	yes
	Indicator/terminal	yes	no	no
Platform waterproof scales	Platform	yes	no	no
	Indicator/terminal	yes	no	no
	Taken off pan	yes	yes	yes

3. WARRANTY CONDITIONS

- A. RADWAG is obliged to repair or change those elements that appears to be faulty because of production and construction reason,
- B. Defining defects of unclear origin and outlining methods of elimination can be settled only in participation of a user and the manufacturer representatives,
- C. RADWAG does not take any responsibility connected with destructions or losses derives from non-authorized or inappropriate (not adequate to manuals) production or service procedures,
- D. Warranty does not cover:
 - Mechanical failures caused by inappropriate maintenance of the device or failures of thermal or chemical origin or caused by atmospheric discharge, overvoltage in mains or other random event,
 - Inappropriate cleaning.
- E. Loss of warranty appears after:
 - Access by an unauthorized service,
 - Intrusion into mechanical or electronic construction of unauthorized people,
 - Removing or destroying protection stickers.
- F. Warranty conditions outline the warranty period for rechargeable batteries attached to the device for 12 months.
- G. The detailed warranty conditions one can find in warranty certificate,
- H. Contact with the central authorized service:
+48 48 384 88 00 ext. 106 or 107.

4. MAIN DIMENSIONS

4.1. Ramp scales

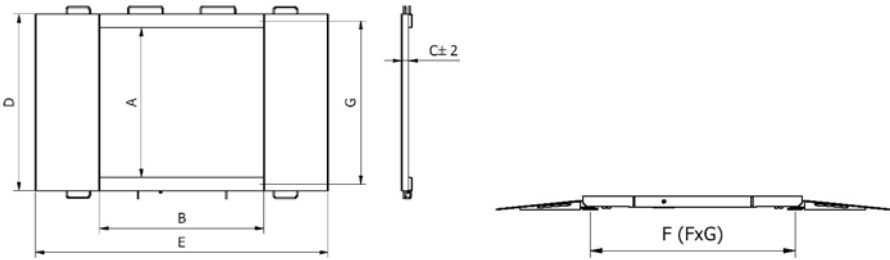

Ramp scales of WPT/4N series								
Scale type	capacity	A [mm]	B [mm]	C [mm]	D [mm]	E [mm]	F [mm]	G [mm]
WPT/4N 400 H1	400kg	840	860	45,5	1040	ok. 1710	777,8	940
WPT/4N 400 H2	400kg	1100	1200	45,5	1300	ok. 2050	1117,8	1200
WPT/4N 800 H2	800kg	1100	1200	45,5	1300	ok. 2050	1117,8	1200
WPT/4N 800 H3	800kg	1200	1500	45,5	1400	ok. 2350	1417,8	1300
WPT/4N 1500 H2	1500kg	1100	1200	52,5	1300	ok. 2150	1117,8	1200
WPT/4N 1500 H3	1500kg	1200	1500	52,5	1400	ok. 2450	1417,8	1300
WPT/4N 1500 H4	1500kg	1500	1500	52,5	1700	ok. 2450	1417,8	1600

4.2. Livestock scales

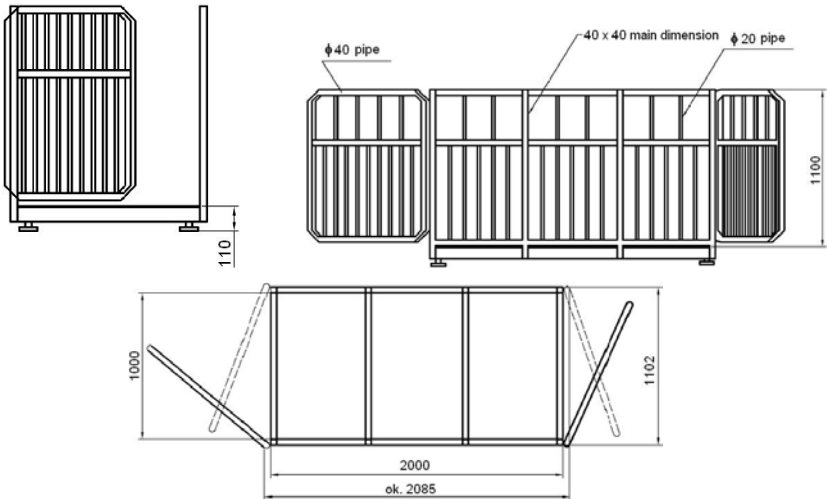

Scales of WPT/4I 2000S(H)1series

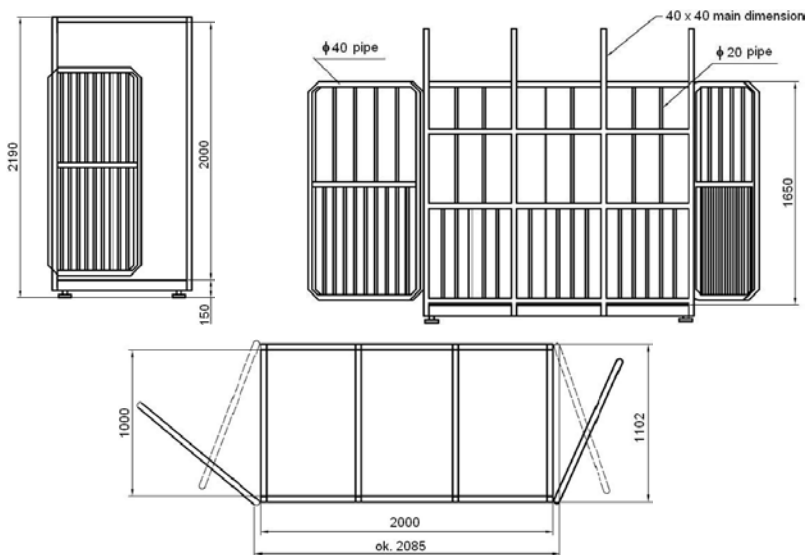

Scales of WPT/4I 2000S(H)2 series

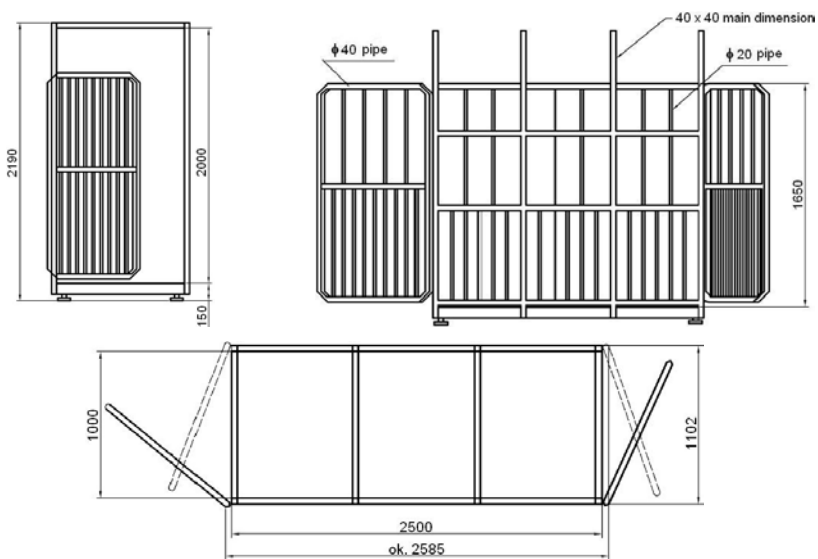

Scales of WPT/4I 2000S(H)3 – series

4.3. Waterproof scales of WPT/H series

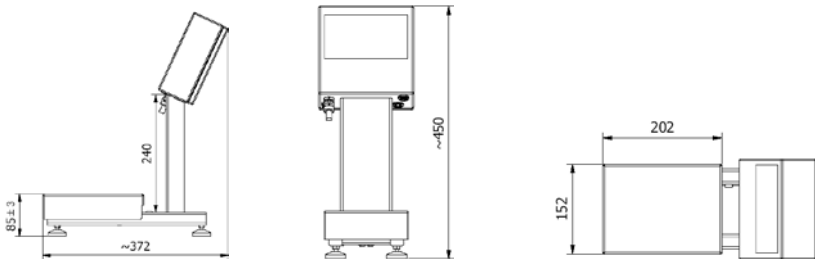

Scales of WPT...H1 series (extension arm 24cm)

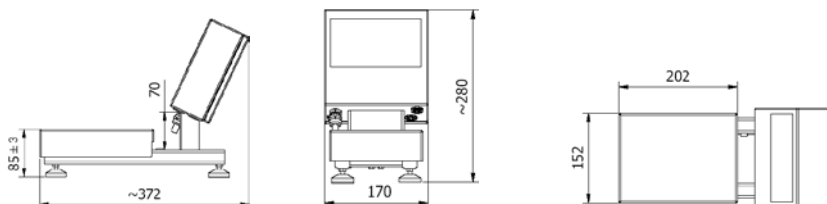

Scales of WPT...H1 series (extension arm 7cm)

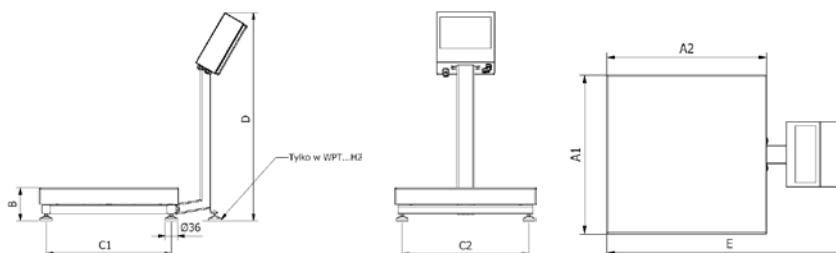

Scale type	A1	A2	B	C1	C2	D	E
WPT...H2	306	246	103 ± 3	268	208	~535	~485
WPT...H2/K	306	246	103 ± 3	268	208	-	-
WPT...H3	411	411	98 ± 2	370	370	~617	~613
WPT...H3/K	411	411	98 ± 2	370	370	-	-
WPT...H4	500	500	155 ± 5	400	400	~790	~718
WPT...H4/K	500	500	155 ± 5	400	400	-	-
WPT...H5	600	600	155 ± 5	500	500	~790	~818
WPT...H5/K	600	600	155 ± 5	500	500	-	-
WPT...H6	800	800	135 ± 5	730	720	~1100	~1050
WPT...H6/K	800	800	135 ± 5	730	720	-	-

Scales of WPT...H2 - WPT...H6 series

4.4. Waterproof scales of WPT/HR series

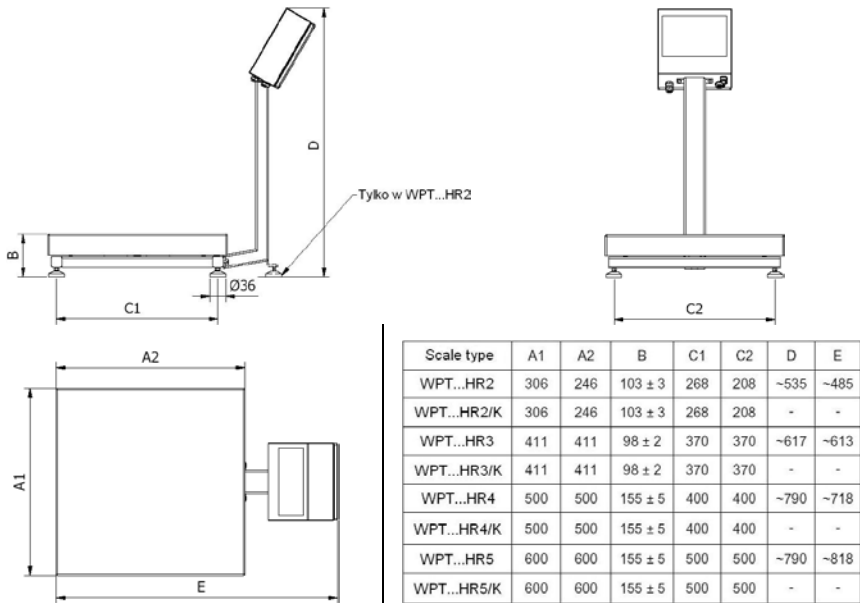

WPT...HR2 - WPT...HR6 series – main dimensions

5. ASSEMBLY AND LEVELLING

5.1. Assembly of scales

A. Overhead scales

- Overhead scales are built of bearing elements and load cells as measuring transducers. Scales are installed on a rail of a load-bearing structure. The load cell is installed in the separated section of the track.
- Overhead scales can be installed only by authorized services of RADWAG. Otherwise the validity of warranty is automatically lost. Do not introduce any mechanical stresses to the weighing system during installation.
- It is forbidden to use any chemical agents comprising penetrators for washing.

- The scale should be periodically cleaned from lubricants and impurities (especially the connection between the scale rail and the crane track).

B. Livestock scales

- Remove the transport protection if installed.
- Screw in levelling feet to mandrels placed in load cells

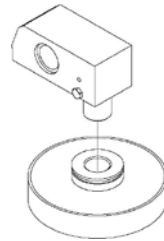
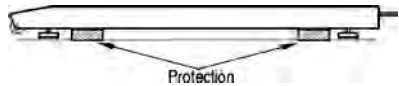

- Put the scale in the spot of usage on a flat stable ground.

C. Ramp scales

- Before setting the scale mount the steel clamping ring (2) to the basis of feet (1) using expanding ring (3) and then screw in the basis of the foot (1) in the mandrel (4).

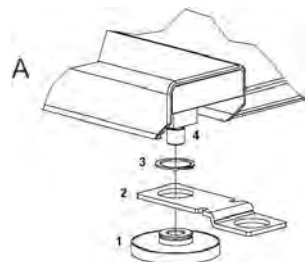
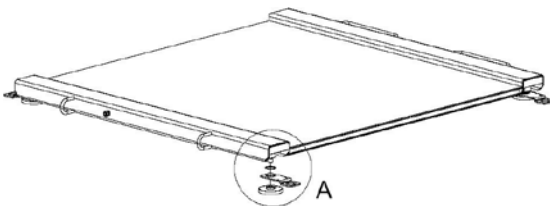

- Put the scale on the flat ground. Put ramps on steel clamping. Take off ramps and mark (through the holes in clamping) places for drilling holes for anchors. After drilling mount clamping to the ground.

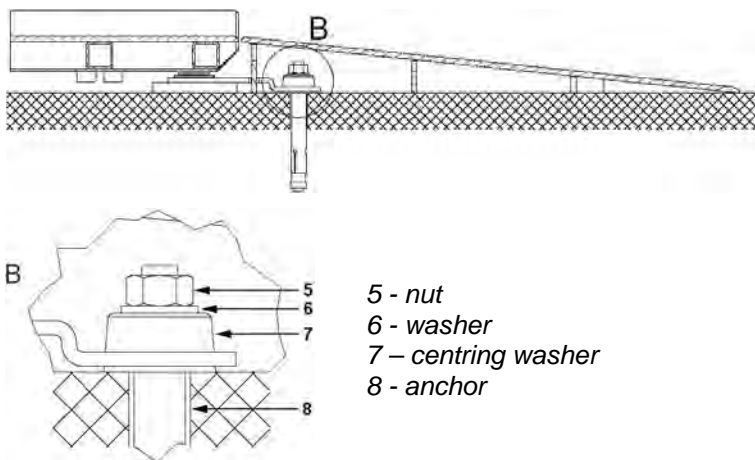

- 5 - nut
- 6 - washer
- 7 - centring washer
- 8 - anchor

D. Waterproof scales of WPT/H, WPT/HR series

Unpack and put the scale on a flat even stable surface far away from sources of heat and then:

- Unscrew the pillar and the transport handler from the platform:

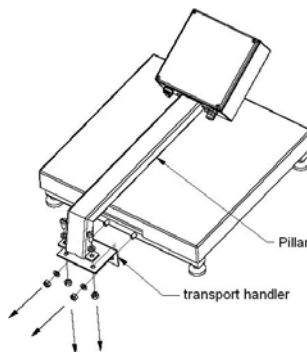

- Turn the pillar and mount it to the platform. The surplus cable place inside the pillar:

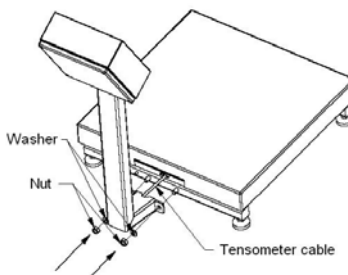

- Pick up the pan and remove the transport protection:

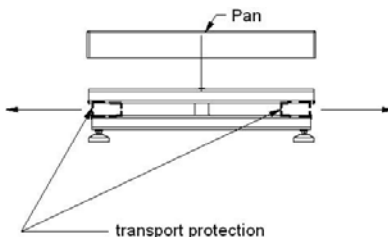

5.2. Levelling the scale

A. Platform scales

After unpacking the scale should be levelled out. Use levelling legs and the level condition indicator installed in the basis of the scale.

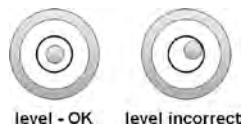

B. Four load cell scales

Level scale by means of turning levelling feet and external level indicator. Put the pads under the regulation legs and observe the level condition indicator. The instrument is levelled correctly if the air bubble do not move more than 2mm from the central position.

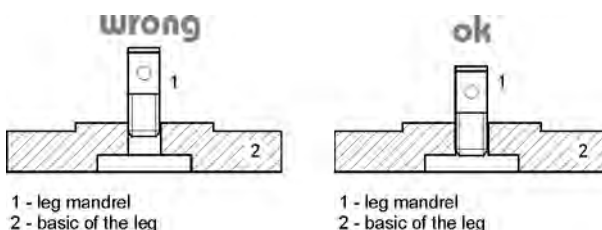

Each leg can be screwed in and out in order to level the scale. Correct levelling can be done by putting steel pads under the legs.

6. GETTING STARTED

After unpacking and mounting (chapter 5 of this manual):

- Turn the device on using the  key – keep pressing the key for about 0.5 sec,

- Wait for the test completion,
- Then you will see **zero indication** and pictograms:

 - zero indication

 - stable result

kg - weight unit

- If the indication is not zero press **zero** key.

7. KEYPAD

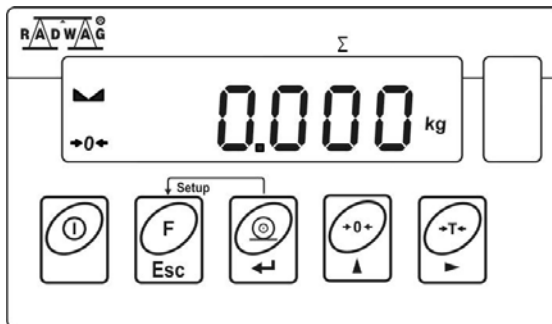

8. KEYS' FUNCTIONS



Switching on/off



Function key (operation mode selection)



Sending a weighing result to RS232





Zeroing





Tarring

Notice:



After pressing  +  keys' functions changes. The way of operation in this mode is described in details further in this manual.

9. INSCRIPTIONS ON THE DISPLAY

No	Text string	Description
1.	FIL	Filter level
2.	bAud	Transmission baud rate
3.	PCS	Piece counting
4.	HiLo	+/- control according to a standard mass
5.	rEPL	Automatic printout
6.	StAb	The condition of printing data
7.	Auto	Autozero correction
8.	t1	Power save – time to switch off while no operation
9.	toP	Latch of the max measurement
10.	Add	Totalizing
11.	AnLS	Weighing animals
12.	tArE	Pamięć 9 wartości tar
13.	-0-	Indication in autozero zone (indication = exact zero)
14.		Stable result (ready to read)
15.	PCS	Operation mode – counting pieces
16.	kg (g)	Operation mode – weighing
17.		Rechargeable battery pack or battery discharged (BAT-LO)
18.	Net	Tare function has been used
19.	Min	+/- control with reference to the standard mass : setting the lower threshold or mass below the first threshold
20.	OK	+/- control with reference to the standard mass: load masa between the thresholds
21.	Max	+/- control with reference to the standard mass: setting the upper threshold or mass over the second threshold

10. USER MENU

10.1. Submenus

User's menu is divided into **6** basic submenus. Each group has its own characteristic name preceded by the letter **P** and a number.

P1 rEAd

P 1.1	Fil		2
P 1.2	Auto		YES
P 1.3	tArA		no
P 1.4	Fnnd		no

P2 Prnt

P2.1	Pr_n		StAb
P2.2	S_Lo		
P2.3	bAud		9600
P2.4	S_rS		8d1SnP

P3 Unit

P3.1	StUn		kg
------	------	--	----

P4 Func

P4.1	FFun		ALL
P4.2	Funi		no
P4.3	PcS		no
P4.4	HiLo		no
P4.5	PrcA		no
P4.6	Prcb		no
P4.7	AtAr		no
P4.8	toP		no
P4.9	Add		no
P4.A	AnLS		no
P4.b	tArE		no

P5 othr

P5.1	bL		Auto
P5.2	bLbt		70
P5.3	bEEP		YES
P5.4	t1		Auto
P5.5	CHr6		YES

P6 CAL

P6.1	St_u		* FUNCTION *
P6.2	uCAL		* FUNCTION *

10.2. Browsing user menu

Use scale's keys to move inside the menu.

10.2.1. Keypad



Entering main menu



Inscribing tare value
Increasing a digit value by „1”
moving down in the menu



Battery / accumulator state monitoring



Toggling between gross / net values



Selecting the parameter or changing the value of a
selected parameter



Entering the selected submenu or activating a parameter
for changes



Confirmation (enter)





Leaving without changes or reaching a higher level of the
menu

10.2.2. Return to the weighing mode



The changes that have been introduced should be saved
in order to keep them in the memory for good.

While leaving parameters press  key until the text

<SAuE?> appears on the display. Then press: 

– to save changes or  – to leave without changes.

11. WEIGHING

Put a load you want to weigh on the weighing pan. When the  pictogram appears it means that the result is stable and ready to read. In order to assure long-term operation and appropriate measurements of weighted loads following precautions should be taken into consideration:

- Loads should be placed on the pan delicately and carefully in order to avoid mechanical shocks:

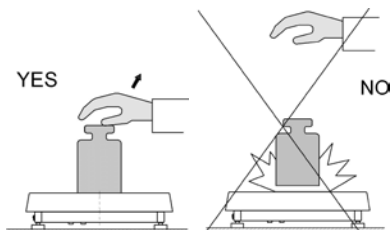

- Loads should be placed centrally on the pan (errors caused by eccentric weighing are outlined by standard PN-EN 45501 ch. 3.5 and 3.6.2):

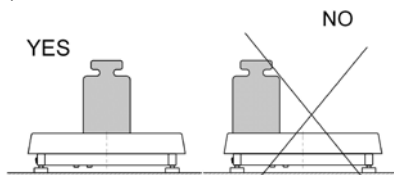

- Do not load the pan with concentrated force:

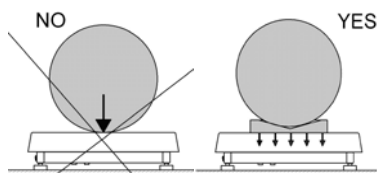

- Avoid side loads, particularly side shocks should be avoided

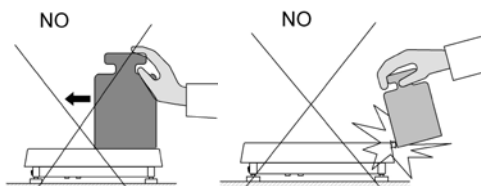

Special line scales should be loaded with intended loads:

- For ramp scales (hand trucks used in meat industry) the platform should be matched to the trucks with maximum weight and the wheels were close to the load-bearing sections:



- For livestock scales – swine, cattle:
 - platforms with low railing for swine,
 - platforms with high railing reinforced connecting links at the top edge.
- For overhead scales (goods hung on hooks) adapted to underslung tracks:
 - Hooks appropriate for the track and scale,
 - Smooth travelling along the load cell without jerks and movements aside,
 - Tensometer (load cell) loaded uniformly.

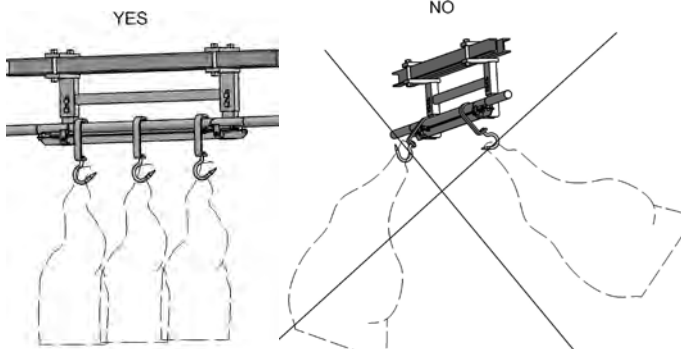

11.1. Tarring

In order to determine the net mass put the packaging on the pan.

After stabilising press  (**Net** pictogram will be displayed in the left upper corner and zero will be indicated).

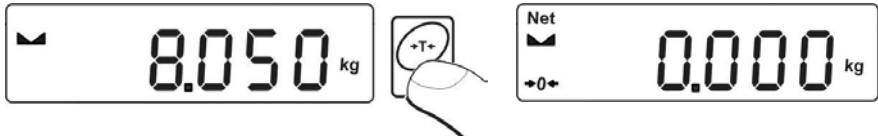

After placing a load on the weight pan net mass will be shown.

Tarring is possible within the whole range of the scale. After unloading the pan the display shows the tarred value with minus sign.





Notice:



Tarring cannot be performed when a negative or zero value is being displayed. In such case <Err3> appears on the display and short audible signal will be emitted.

11.2. Inscribing tare value

You can also inscribe a tare value. While in weighings mode press:

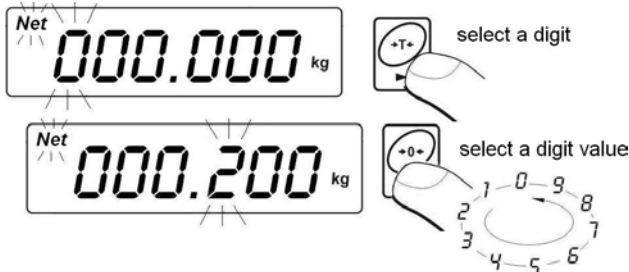
- Press simultaneously  and ,
- You will see :





- Using  and  set the tare value,
- Press ,
- Program returns to weighings mode. The inscribed tare value can be seen on the display with „-“ sign,
- Tare can be inscribed anytime in weighings mode.

Notice:

1. You cannot inscribe a new tare value when the tare value in memory is greater than zero. In the case of trying this the **<Err3>** message will be displayed and short audible signal will be emitted.
2. Users can also enter up to 9 tare values to the scale memory (see 15.10 of his manual).

11.3. Zeroing

To **ZERO** the scale press: .

The scale will display zero and following pictograms: $\rightarrow 0 \leftarrow$ and . Zeroing is only possible within the scope of $\pm 2\%$ of full scale. While zeroing outside the scope of $\pm 2\%$ you will see **<Err2>**. Zeroing is possible only in stable state.

Notice:

*Zeroing is possible only within the $\pm 2\%$ interval of the maximal range. If zeroing is performed beyond this range the **<Err2>** message and short audible signal will be emitted.*

11.4. Weighings in two ranges

Switching between the **I range** and the **II range** happens automatically (exceeding Max of the **I range**). Weighings in the second range is signalled by a pictogram in the top left corner of the display.

Then weighings is done with the accuracy of the **II range** to the moment of returning to zero (autozero range $\rightarrow 0 \leftarrow$) where the scale switches back to the **I range**.

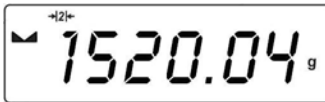



11.5. Selection of basic weight unit

This function is used to set weight unit the scale will start with.

Procedure:

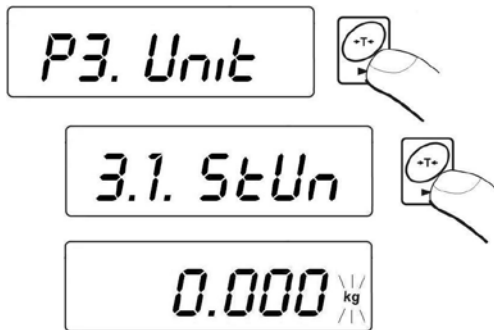
- Enter the submenu **<P3.Unit>** and then:



- press , until the expected unit appears on the display:



Options:

- When the basic unit is [kg], users can toggle between: [kg, lb, N], *for verified scales [lb] is not accessible*,
- If the basic unit is [g], users can toggle between: [g, ct, lb], *for verified scales [lb] is not accessible*,

- After you select the unit press , the scale returns to:

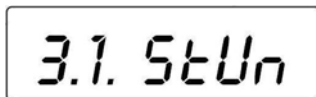

- Return to weighing according to chapter - 10.2.2.

Notice:

After turning on the scale always sets the basic unit.

11.6. Temporarily selected unit

This function is used to set weight unit the scale will use temporarily until the next power off or next selection.

Procedure:

- Press  and then:

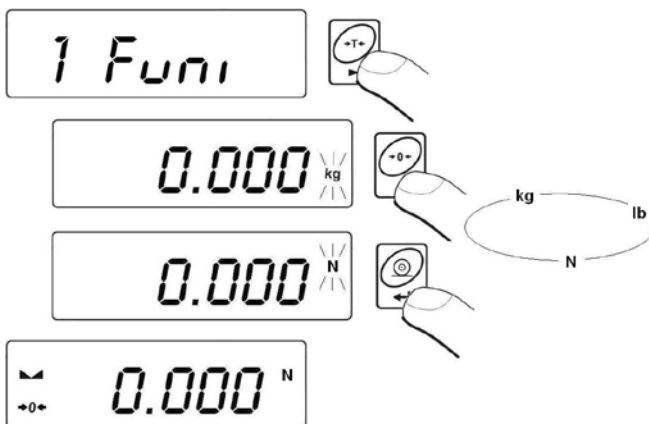

- After you select the unit you want come back to weighing procedure.

Options:

- A. When [kg] is a basic unit, users can select following units:
[kg, lb, N], [*lb*] is not accessible for verified scales;
- B. When [g] is a basic unit, users can select following units:
[g, ct, lb], [*lb*] is not accessible for verified scales.

12. MAIN PARAMETERS

Users can adjust the scale to external ambient conditions (filtering level) or particular needs (autozero operation, tare memory). This parameters are placed in <P1.rEAd> submenu.

12.1. Setting a filtering level

Procedure:

- Enter the submenu <P1.rEAd> and then:

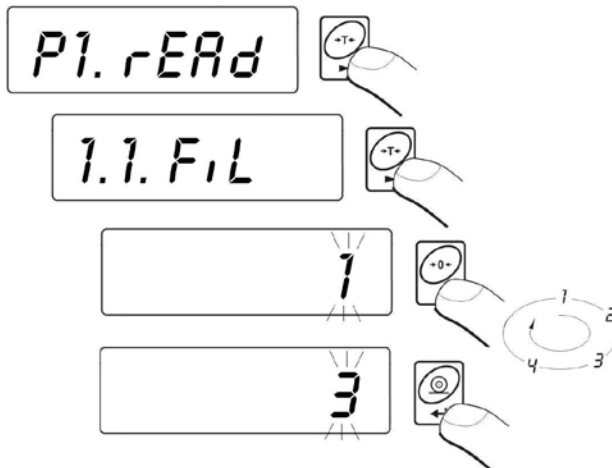

1 - 4 - level of filtering

- By pressing  select the filtering level you need.

Notice:

Filtering level influences the time of stabilization. The higher the filtering level is the longer stabilization time is needed.

Return to weighing:

See - 10.2.2.

12.2. Median filter

This filter eliminates short changes (impulses) of measure signal (e.g. shocks).

Procedure:

- Enter the submenu **<P1.rEAd>** and then:

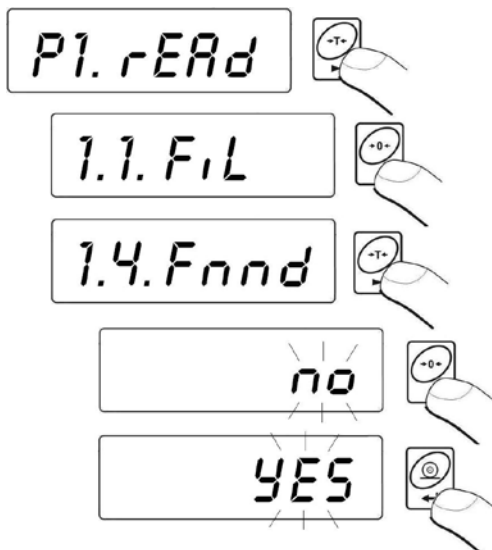



Fnnd **no** - filter disabled
Fnnd **YES** - filter enabled

Return to weighing:

See - 10.2.2.

12.3. Autozero function

The autozero function has been implemented in order to assure precise indications. This function controls and corrects „0” indication. While the function is active it compares the results continuously with constant frequency. If two sequential results differ less than the declared value of autozero range, so the scale will be automatically zeroed and the pictograms  and  0  will be displayed.

When AUTOZERO is disabled zero is not corrected automatically. However, in particular cases, this function can disrupt the measurement process e.g. slow pouring of liquid or powder on the weighing pan. In this case, it is advisable to disable the autozero function.

Procedure:

- Enter the submenu <P1.rEAd> and then:

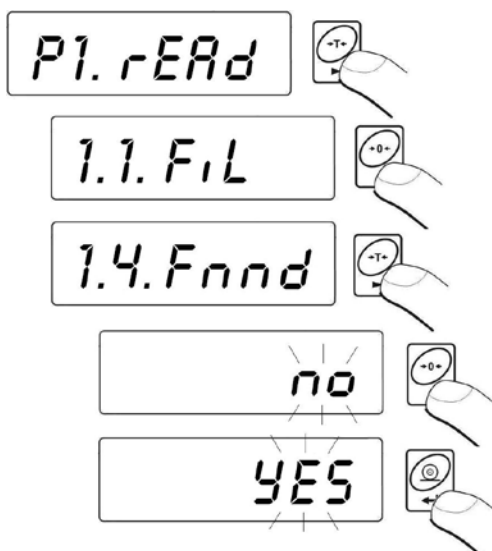

Fnnd no - filter disabled
Fnnd YES - filter enabled

Return to weighing:

See - 10.2.2.

12.4. Tare function

This parameters enables users to configure a tare function.

Procedure:

- Enter the submenu **<P1.rEAd>** and then:



- tArA AtAr** - **automatic tare function on** and is stored in balance memory after unplugging it from mains (Description of function operating point 15.6 automatic tare)
- tArA no** - **automatic tare function off** (user can turn on operating of automatic tare **<F6 AtAr>** – till unplugging the balance from mains)
- tArA tArF** - **tare memory function** – stores last value of tare in balance memory. It is automatically displayed after starting the balance. Value of tare is displayed with minus sign, and there is **Net** symbol indicated on the display. (user can turn on operating of automatic tare **F6 AtAr** – till unplugging the balance from mains)

Return to weighing:

See - 10.2.2.

13. RS 232 PARAMETERS

External devices connected to RS 232C have to be supplied from the same mains and common electric shock protection. It prevents from appearing a potential difference between zero leads of the two devices. This notice does not apply to the devices that do not use zero leads.

Transmission parameters:

- Baud rate - 2400 – 38400 bit / s
- Data bits - 7,8
- Stop bits - 1,2
- Parity control - no, even, odd

There are four ways of sending data via RS232 interface:

- **Manually** – after pressing ,
- **Automatically** – after stabilizing the indication over **LO** threshold
- **Continuously** – after it is activated in parameter or by a command sent via RS232
- **On external request** - see - „List of scale - computer commands”.

The indication can be sent as:

- **stable** – the indication is sent after the scale stabilizes.
- **any** – the indication is sent immediately after pressing the  key, this state is assign with **<?>** in the printout.

13.1. Printout type

This parameter is to select the type of printout.

Procedure:

- Enter the submenu **<P2.Prnt>** and then:

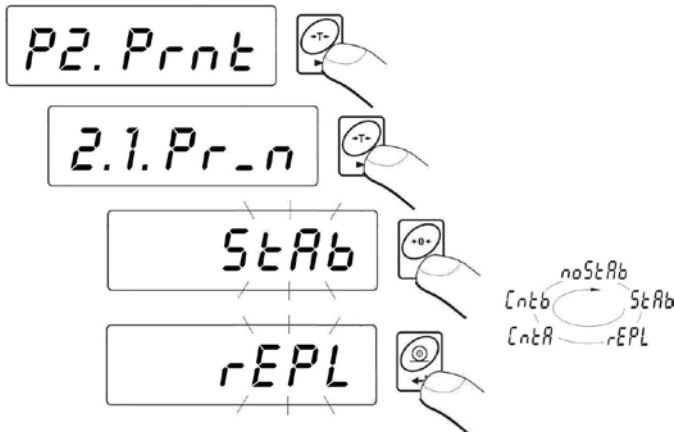

- | | | |
|-------------|---------------|---|
| Pr_n | noStAb | - immediate printout
(not accessible in verified scales) |
| Pr_n | StAb | - sending stable results |
| Pr_n | rEPL | - automatic operation |
| Pr_n | CntA | - continuous transmission in basic unit |
| Pr_n | Cntb | - continuous transmission in present unit |

Return to weighing:
see 10.2.2.

13.2. Minimal mass threshold

This function is necessary while working with **automatic tare** or **automatic operation** or **weighing animals**.

Automatic tarring will not be applied until the indication (gross) is lower than the value inscribed in **S_Lo** parameter.

In automatic operation measurements (net) are sent via RS232 when the indication is equal or greater than the value inscribed in **S_Lo** parameter.

Weighings animals is performer when the indication is equal or greater than the value inscribed in **S_Lo** parameter.

Procedure:

- Enter the submenu **<P2.Prnt>** and then:

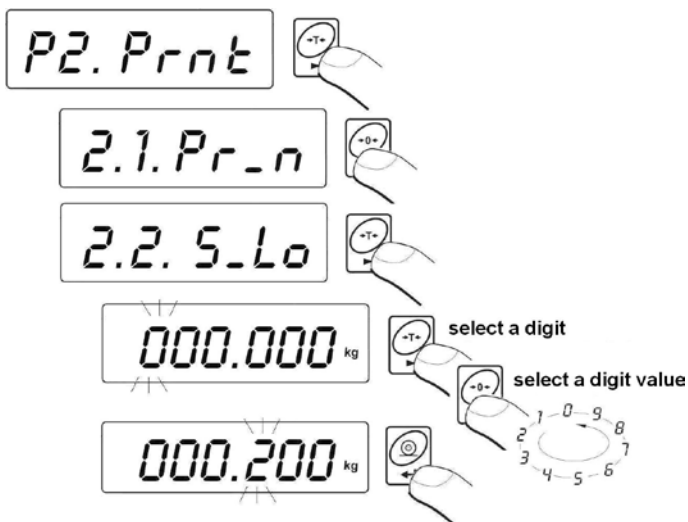

Return to weighing:
see 10.2.2.

13.3. Baud rate

Procedure:

- Enter the submenu `<P2.Prnt>` and then:

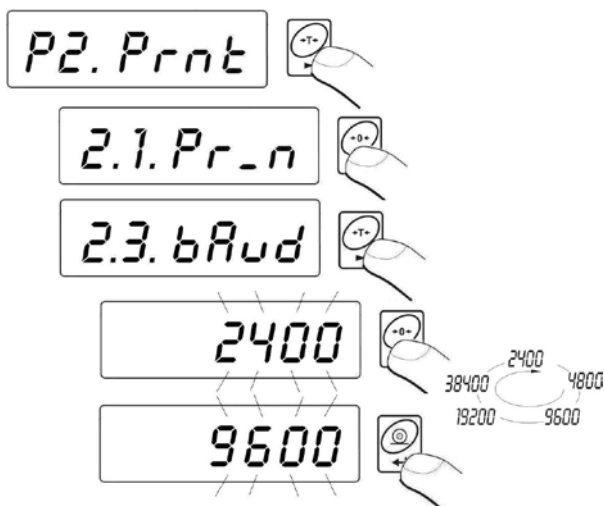

Return to weighing:
see 10.2.2.

13.4. Serial transmission parameters

Procedure:

- Enter the submenu **<P2.Prnt>** and then:

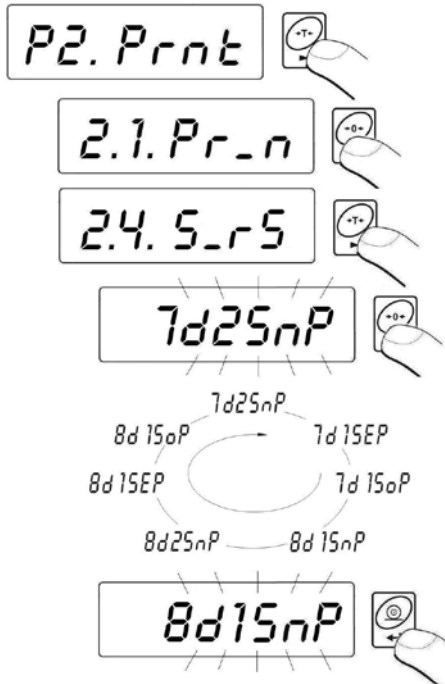

- 7d2SnP** - 7 data bits; 2 stop bits, no parity control
- 7d1SEp** - 7 data bits; 1 stop bit, EVEN parity control
- 7d1SoP** - 7 data bits; 1 stop bit, ODD parity control
- 8d1SnP** - 8 data bits; 1 stop bit, no parity control
- 8d2SnP** - 8 data bits; 2 stop bits, no parity control
- 8d1SEp** - 8 data bits; 1 stop bit, EVEN parity control
- 8d1SoP** - 8 data bits; 1 stop bit, ODD parity control

Return to weighing:
See 10.2.2.

14. OTHER PARAMETERS

The user can set parameters which influence the scale operation. They are gathered in the submenu **P5. Othr** e.g. backlight and beep signal. Enter this submenu **P5. Othr** according to chapter 10.2.

14.1. Backlight function

Program recognises the way the scale is supplied (mains, battery) and automatically selects the way of operating on the backlight:

- bl** – for mains
- blbt** – for batteries or rechargeable battery pack

14.1.1. Backlight for supplying from mains

Procedure:

- Enter the submenu **<P5.othr>** and then:

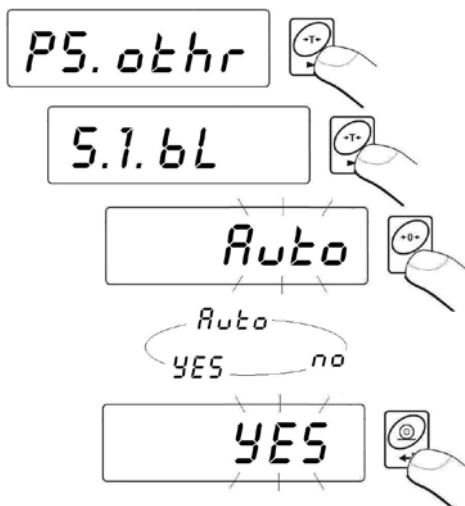

- bl no** - backlight switched off
- bl YES** - backlight switched on
- bl Auto** - backlight switched off automatically if indication becomes stable for about 10s

Return to weighing:
See 10.2.2.

Notice:
When *bl=Auto*, and the indication has not changed for 10s, the backlight is automatically switched off. The backlight is switched on again automatically after the result changes.

14.1.2. Backlight for supplying from batteries

The user can change the intensity of backlight from 0% to 100%. The lower the intensity is the longer the scale operates without recharging or exchanging batteries. When the intensity is set this function works as AUTO (described above).

Procedure:

- Enter the submenu **<P5.othr>** and then:

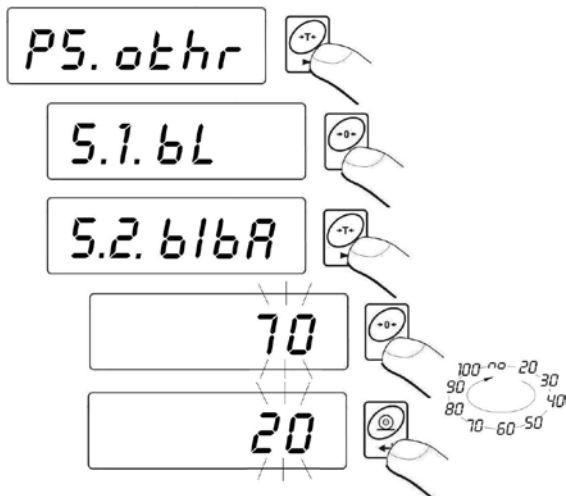

Return to weighing:
See 10.2.2.

Notice:
The more intense the backlight is the shorter the scale operates on batteries.

14.2. “Beep” signal – after pressing a key

Procedure:

- Enter the submenu <P5.othr> and then:

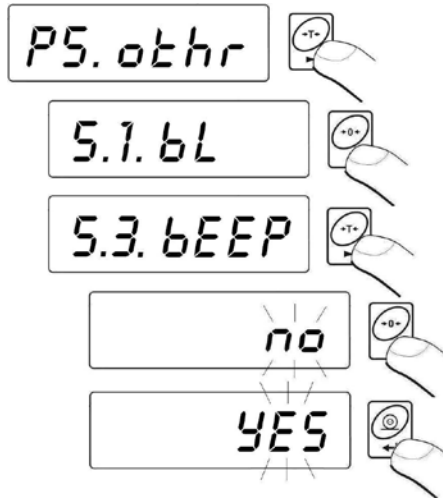

bEEP **no** - switched off
bEEP **YES** - switched on

Return to weighing:

See 10.2.2.

14.3. Automatic switch-off

This function is essential to save the battery power. The scale is switched off automatically when (function **t1 = YES**) no weighing appears in 5 minutes. (no changes on the display). In case when this function disrupts the operation (e.g. long time weighing procedures) or while working with connection to mains, switch off this function.

Operation according to the power supply:

Setting	Operation	
	Mains	Batteries/accumulator
t1 = 0	disabled	disabled
t1 = YES	enabled	enabled
t1 = Auto *	disabled	enabled

* automatic enabling/disabling according to the source of power.

Procedure:

- Enter the submenu **<P5.othr>** and then:

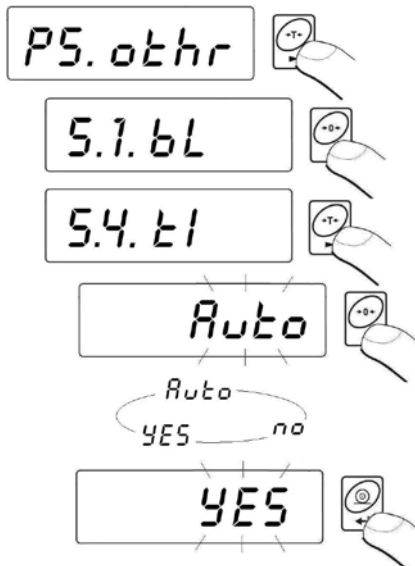

Return to weighing:

See 10.2.2.

14.4. Battery voltage level check

While supplying from batteries too low level of voltage is measured by software the pictogram  is displayed. It means that charging or exchanging batteries is required.

14.4.1. Checking the batteries

This function is to check the level of battery supply. It works only if:

- Weighing mode is set,
- Battery supply is set in parameters.

Procedure:

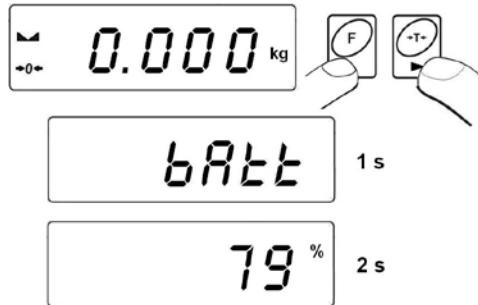



After displaying the level of batteries (in per cents) the program returns to weighing.

14.4.2. Battery discharge pictogram

The symbol (bat low) switches on when the voltage level drops to 18% of the accepted level of voltage. It means that charging or exchanging batteries is required.

Low level of batteries:

- Pictogram  on the display,
- After one time the device will automatically switch off to protect the batteries from destructable discharging,
- Charging is signalled by  (blinking period about 2 seconds) on the display.



14.4.3. Accumulator charging option

This function allows to switch on the charging algorithm for **SLA** jell cell battery:

a) Parameter **<CHr6>** set to **<no>**:

- Pictogram  does not appear, charging disabled.
- During software initializing, after turning on **<bAtt>**.

b) Parameter **<CHr6>** set to **<YES>**:

- Pictogram  blinks slowly (period about 2 seconds), charging is enabled.
- Message **<SLA>** appears on the display,
- In case of damaging accumulators or lack of it the pictogram  blinks quickly (period about 0.5 sec).

Notice:

*Standard scales are equipped in an **SLA** jell cell battery pack and a power adapter.*

Procedure:

- Enter the submenu **<P5.othr>** and then:

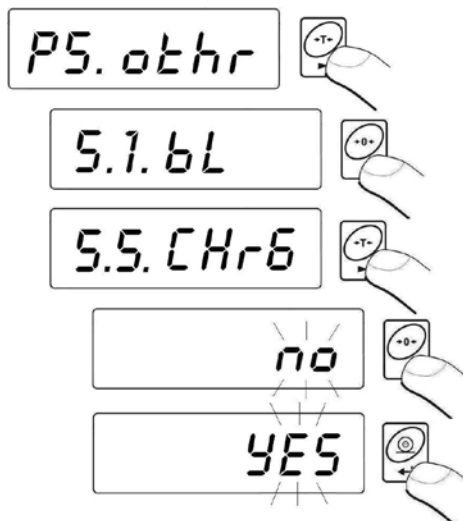

CHr6 YES - enabled
CHr6 no - disabled

Return to weighing:
See 10.2.2.

15. WORK MODES

15.1. Setting accessibility of operation modes

In this parameter group users can disable/enable accessibility of functions after pressing  key.

Procedure:

- Enter the submenu **<P4.Func>** and then:

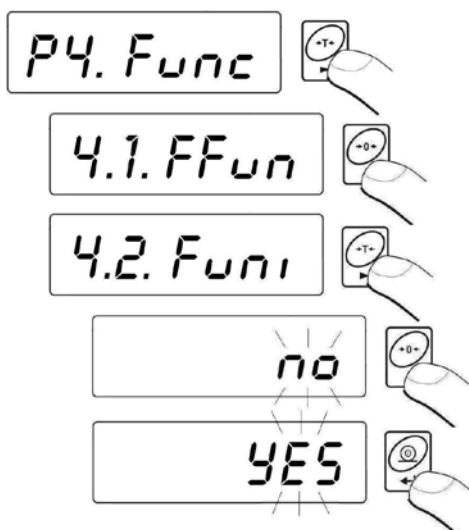

no - mode is disabled
YES - mode is enabled

Return to weighing:
See 10.2.2.

15.2. Selecting quantity of operation modes

This function enables user to set if ,after pressing  key, all operating modes will be accessible (**ALL**) or only one from the list chosen and used by operator.

Procedure:

- Enter the submenu **<P4.Func>** and then:



After choosing setting press  key. The program will return to displaying name of submenu **<P4.1.FFun>**.

Return to weighing:

See 10.2.2.

15.3. Counting pieces of the same mass

Standard solution is equipped with option of counting small pieces of the same mass. It is possible to execute a tare function in this operating mode in order to tare a container value.

Notice:

1. Counting pieces does not work together with other scale functions,
2. The counting pieces function is not saved as a default start function so it is not remembered after restarting.

Procedure:

- Enter to **<PcS>** function:

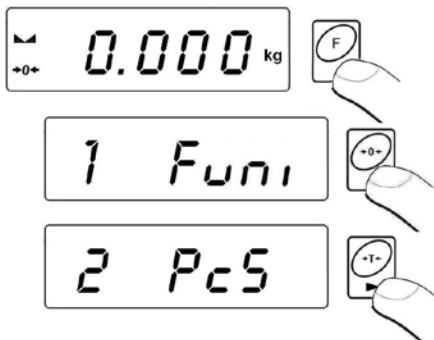



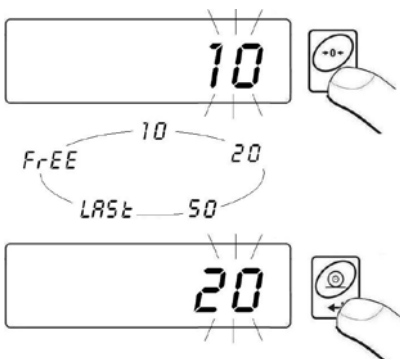

- You will see a blinking value of sample quantity.
- Press  key to start setting quantity of sample, you have a few options to chose from:



- If option **<LAST>** is chosen in the scale program displays estimated unit mass of the last piece (about 3 seconds) and then goes to **Counting pieces** automatically setting the previously displayed value as valid for the procedure.
- If the **<FrEE>** option is selected you will see:



- Using  and  enter the required sample quantity, where:  - selection of digit position,  - setting the digit,
- Confirm the value by pressing ,
- You will see **<LoAd>** on the display and then:

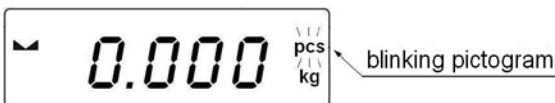

- If weighing is performed in a container put the container on the pan first and then tare it. Then put the declared quantity of pieces on the pan and confirm it when stable (signalled by ):

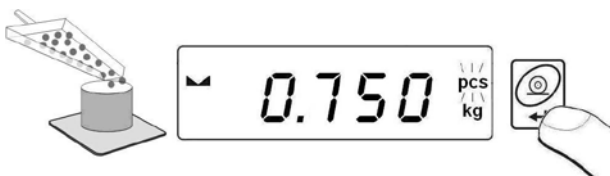

- The program will automatically calculate the mass of a single piece and go on to the **Piece Counting** mode (**pcs**). You will see the following display:



Notice:



1. If a user presses the  key when load is not present on the pan, the message **-Lo-** will be indicated for a few seconds and the scale will automatically return to weighing.
2. In order to comply with the rules of appropriate counting pieces put as many pieces as possible during unit mass adjustment. Single piece mass should not be less than 5 divisions.
3. If a single piece mass is lower than a reading interval d the display will show the **<Err5>** message (see ch. 20. Error messages) and short audible signal will be emitted than the scale returns to weighing.

Return to weighing:



- Press the  key twice.

15.4. +/- control referring to the inscribed standard mass

Procedure:

- Enter to **<HiLo>** function:

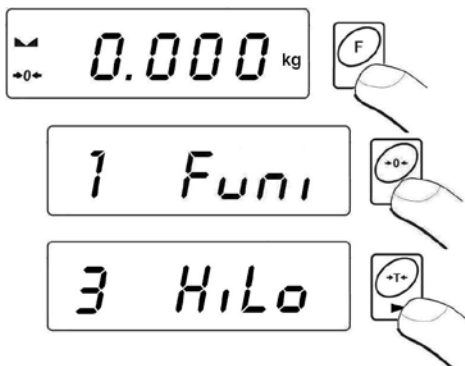

- The program enters the window of setting the lower threshold of weighing (**Min**):

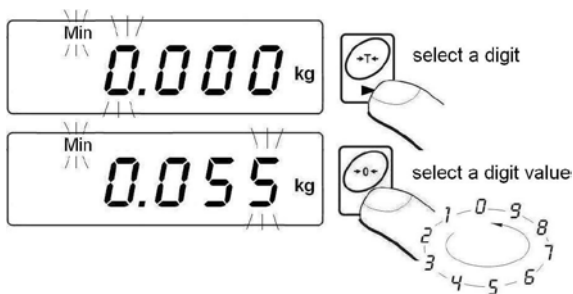

- The inscribed value confirm by pressing , the program will automatically go to the higher threshold of weighing (**Max**):

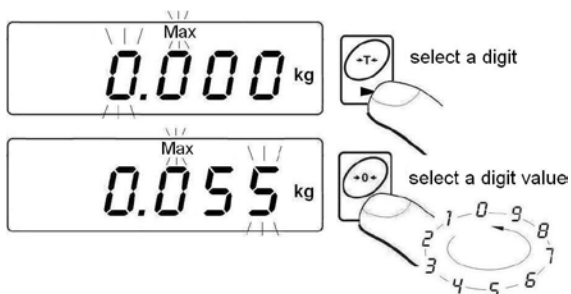

- The inscribed value confirm by pressing , the program will automatically go to the main window.
- During setting threshold values following cases take place:

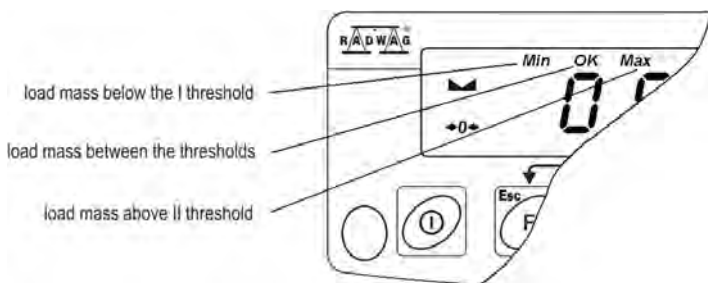

Notice:

If a user erroneously enters a value of the lower threshold higher than the upper one, the scale will indicate an error message and will return to weighing.

Return to weighing:

- Press the  key twice.

15.5. Control of % deviation referring to the inscribed standard mass

Scale software enables control of deviation (in %) of weighed loads mass referring to the inscribed standard mass. Mass of standard can be determined by its weighing (**PrcA** function) or entered to the scale memory by an user (**PrcB** function).

15.5.1. Standard mass determined by its weighing

Procedure:

- Enter to **<PrcA>** function:

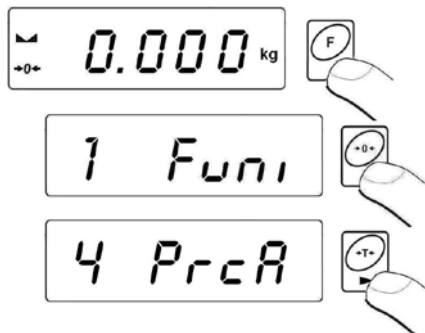

- You will see **<LoAd>** on the display and then:



- place an load on the pan which mass will be accepted as standard
- press  to confirm this operating mode
- after few seconds the indication **100,00%** will be displayed
- From this moment display will not indicate mass of weighed load but deviation of load mass placed on the pan referring to the mass of standard (in %).

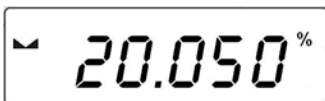

Return to weighing:

- Press the  key twice.

15.5.2. Mass of standard inscribed to scale memory



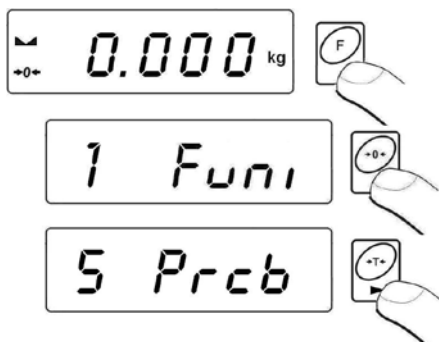

Procedure:

- Enter to <PrcB> function:



- The program goes to the weight display window:



- Using  and  set **standard mass**,
where:  - digit selection,  - digit setting.
- Confirm the entered value by pressing .
- You will see the indication equal to **0,000%**,
- From this moment display will not indicate the mass of weighed load but deviation of the load mass placed on the pan referring mass of standard (in %).

Return to weighing:

- Press the  key twice.

15.6. Automatic tare

This function is useful for fast net mass determination of weighed load in case when tare value of is different for each load. In case when the function is active the cycle of scales operating looks as follows:

- press zeroing key when the pan is empty,
- place the container for pieces,
- when indication is stable **automatic tarring** of the container mass will be performed (**Net** marker will appear in the upper part of the display),
- place a sample into the package,
- display will indicate net mass of sample,
- remove the sample together with the container,
- display will indicate tare mass with minus sign,
- place a container for the next sample. When indication is stable automatic tarring will take place (**Net** marker will appear in the upper part of the display),
- place next sample into the package.

Procedure:



Return to weighing:

- Press the  key twice.

15.7. Measurement max force on the pan – latch

Procedure:

- Enter to **<toP>** function:

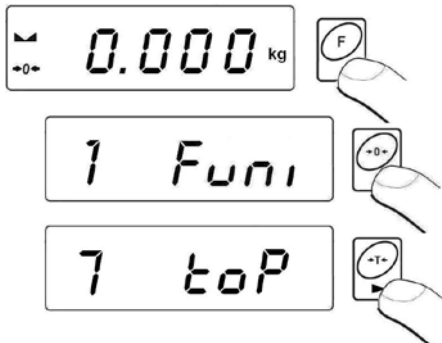

- Confirmation of choice of **<toP>** function is indication of the **Max** pictogram:



- Apply a force to the weighing pan.
- The display of scale will latch the maximum value of the force
- Remove loads from the pan
- Before the next measurement press the  key.

Return to weighing:

- Press the  key twice.

15.8. Totalizing

Scale software is equipped in a totalizing function of single weighings. The totalizing procedure can be documented on the printer connected to the indicator.

15.8.1. Enabling the work mode

Procedure:

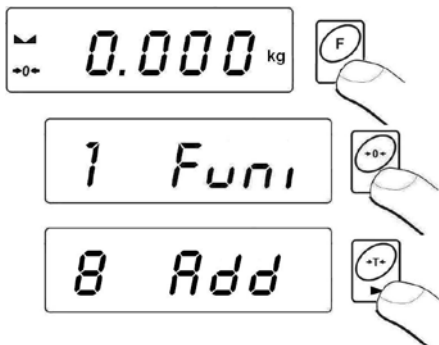

- Enter to **<Add>** function:





- A letter „P” in the left side of the display is a confirmation that **<Add>** function have been selected:



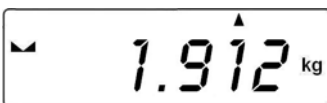

15.8.2. Totalizing procedure

- Enter **<Add>** function according to ch. 15.8.1,
- Put the first load on the pan. If the weighing procedure is performed in a container put the container on the pan first and tare it. Then put the first load on the pan and confirm it by pressing  when stable (signalled by );
- You will see a sum of weighings on the display, the „▲” pictogram in the upper right corner will be displayed and the weighing result will be printed on the printer connected to the indicator.



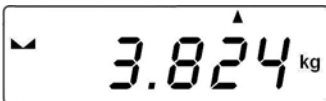

- Take off the load from the pan, indication returns to **ZERO** and the letter „**P**“ in the left part of the display appears,
- Put the next load on the pan,
- After stabilizing press , the sum of first and second weighing will appear on the display, the „▲“ pictogram in the upper right corner will be displayed and the second weighing result will be printed on the printer connected to the indicator:



- Press  to complete the procedure (with the loaded or unloaded pan), a sum of all weighings will be printed:

(1) 1.912 kg
(2) 1.912 kg





TOTAL: 3.824 kg

- In case of pressing  one more time with loaded pan, you will see the <unLoAd> message. Unload the pan, the scale will return to **ZERO** and the letter „**P**“ in the left part of the display will appear. The scale is ready for the next procedure.
- In case of pressing  one more time with loaded pan, you will see the letter „**P**“ in the left part of the display will appear. The scale is ready for the next procedure.

15.8.3. Memory of the last value of sum of weighed goods

After interrupting (e.g. switching off) the totalizing procedure, it is possible to restart the procedure without losing data. In order to do it just enter the totalizing procedure:



- Enter <Add> function again according to the ch. 15.8.1 of the manual,
- You will see the last memorized sum of weighings on He display.

- In order to continue the procedure press , the indication returns to **ZERO** and the letter „P” appears in the left part of the display. The scale is ready for weighing.
- In order to terminate the previous totalizing procedure press  key, , or . You will see the letter „P” in the left part of the display. The scale is ready for weighing.



15.8.4. Return to weighing

- Press  key, you will see:

P r n t ?

- Before leaving the <Add> function it is possible to print out subsequent weighings and the sum of weighings on the connected printer (press  to print, press  to cancel),
- The following message will appear on the display:

E S C ?

- Press  key to return to weighing,
- Press  to return to totalizing.

Notice:

*In case of overflow of the range of the display in totalizing you will see <5-FULL> message in the display. In that case unload the pan and press **PRINT** to complete the procedure with a printout of sum of all weighings or put a lower mass on the pan which does not cause the overflow error.*

15.9. Weighing animals

Procedure:

- Enter to **<AnLS>** function:

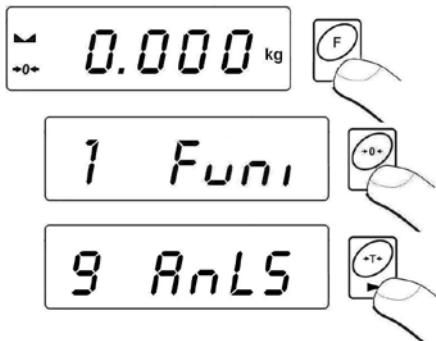

- The **<tinnE>** message appears on the display for **1s**, and then the program goes to the window of setting the duration time (in seconds) of the animal weighing process:

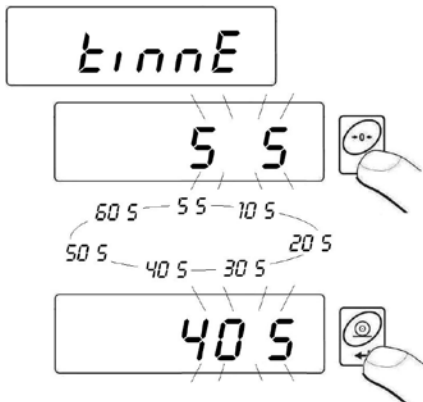

- Confirm the selected value by pressing 
- You will see the following window:

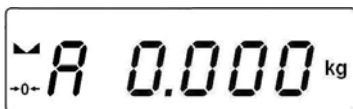

- Load an animal to the platform,
- After exceeding the **-LO-** value (see 13.2), program starts the weighings process. The appearance of subsequent hyphens <-----> showing the progress,
- After completing the process of weighings the result is latched on the display and additionally the **OK** pictogram is shown in the upper part of the display:

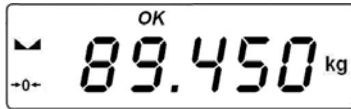

- You can start the procedure of weighing animals again by pressing ,
- After removing the animal from the platform program returns to the window:



Return to weighing:

- Press .

15.10. Tare memory

Users are allowed to Enter Up to 9 tare values to the memory.

15.10.1. Entering the tare value to the scale memory

Procedure:

- Enter to **<tArE>** function:

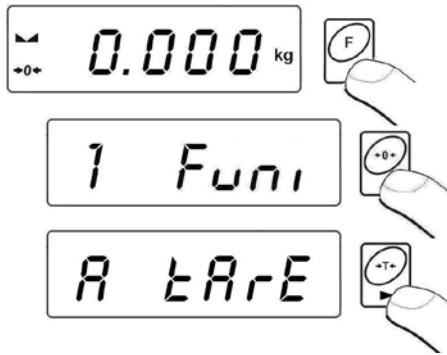

- The program goes to displaying the first value from the selection of tare values <tArE 0> (press  to chose different values):

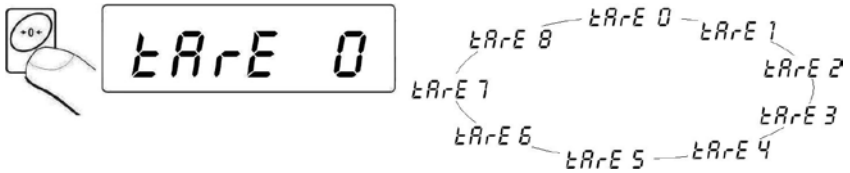

- After selecting the right position press  and you will see an editing field:

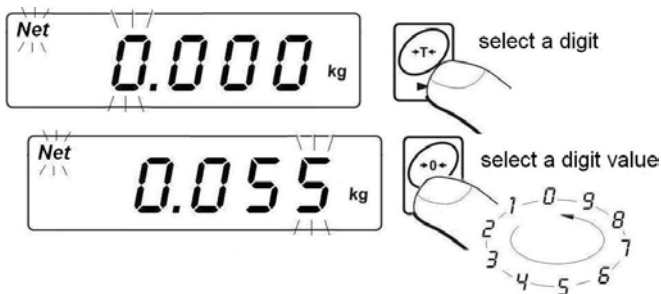

- Enter the selected **tare value** to the scale memory ,
- The program returns to the following window:

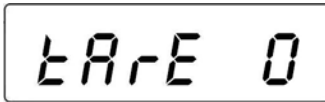



Return to weighing:

- Press .

15.10.2. Selecting a tare value from the memory

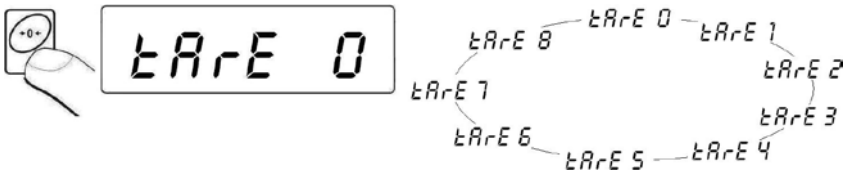
- Enter <tArE> function according to the ch. 15.10.1 of the manual,
- The program goes to displaying the first value from the selection of tare values <tArE 0> (press  to chose different values):



- To use an entered tare value press , you will see the tare value on the display preceded by the „-„ sign and the **Net** pictogram:



Caution:

A tare value from the memory is not remembered after powering off and on the scale.

16. USER CALIBRATION

Only for non-verified scales

Confirmation of high accuracy of weighing requires periodical correcting of calibration factors in the scale memory – this is adjustment of the scale. Calibration should be performed when we start weighing or dynamic change of temperature occurs. Before starting calibration remove loads from the pan.

16.1. Calibration

Procedure:

- Enter the submenu <P6.CAL> and then:

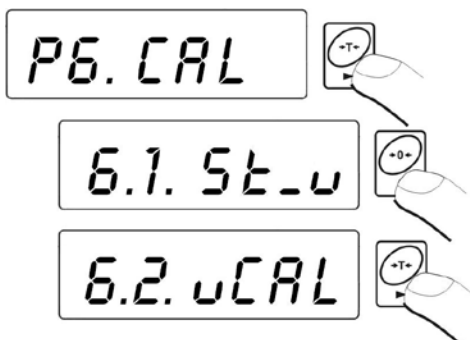

- Following inscriptions will appear

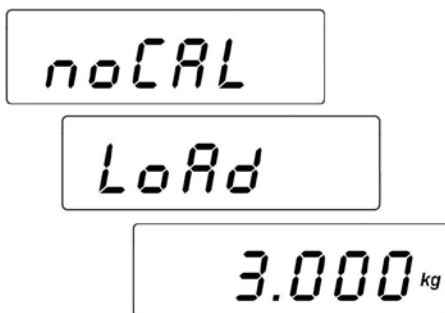

- A new start mass is adjusted during this period of time. After that a mass of calibration weight is shown (e.g. 3 000kg).

- Put a weight of the displayed mass value on the pan and press . The calibration process will start which is signalled by the message:

CAL

- After completion of the process of calibration the following screen will appear

unLoAd

- Take off the weight , then the following sequence of screens will appear

donE

6.2. uCAL

- Calibration process can be terminated anytime by pressing  which is signalled by the following message on the display:

Abort

- Return to weighing with saving changes that have been made.

Caution:

If the calibration process (span adjustment) lasts longer than 15 the <Err8> message will be displayed and short audible signal will be

emitted. Press  to perform calibration again with more stable ambient conditions!

16.2. Start mass adjustment

If the scale does not require the full calibration process it is possible to adjust only a new start mass.

Procedure:

- Enter the submenu <P6.CAL> and then:

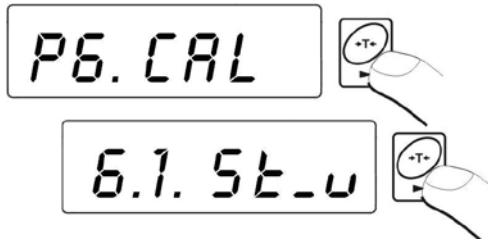

- The display will show the following information



- After the completion of the start mass adjustment the following screen will appear:

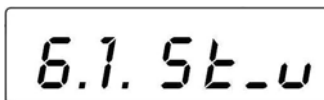

- The process of start mass adjustment can be terminated by pressing , which is signalled on the display:

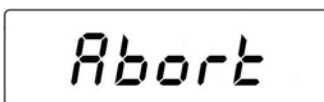

- Return to weighing performing the procedure of saving parameters.

Caution:

If the start mass adjustment lasts longer than 15 the **<Err8>** message will be displayed and short audible signal will be emitted. Press  to perform calibration again with more stable ambient conditions!

17. COOPERATION WITH PRINTER

Each time the  key is pressed a current mass value together with mass units is sent to RS 232 interface.

Depending on setting of **STAB** parameter it can be printed out with temporary or stable value. Depending on setting of **REPL** parameter, printout will be automatic or manual.

Cable diagrams:

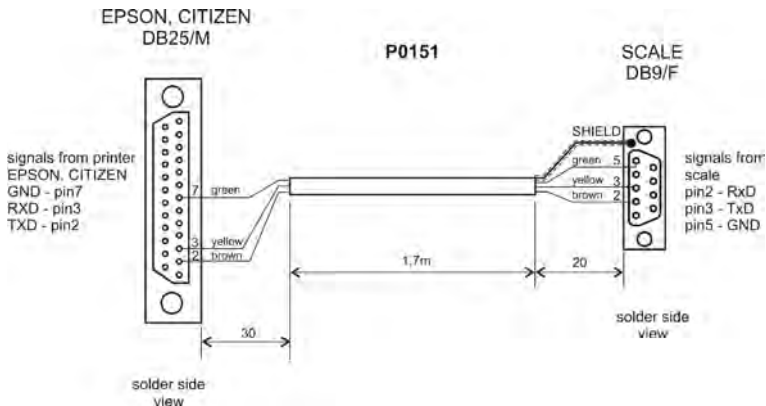

Scale – printer cable diagram for plastic casing

18. COOPERATION WITH COMPUTER

Sending weighing results to the computer can be done:

- manually
 - in continuous way
 - automatically
 - on the request from the computer
- after pressing  key,
 - after function activating or sending an appropriate command,
 - After stabilizing the indication
 - After sending a control command

These scales can cooperate with „**EDYTOR WAG**” program. The indicator window comprises the most important information from the scale display. The program allows to configure easily, e.g. design printouts, edit parameters. A precise description is issued in the „Help” file that accompanies the program.

Cable diagrams:

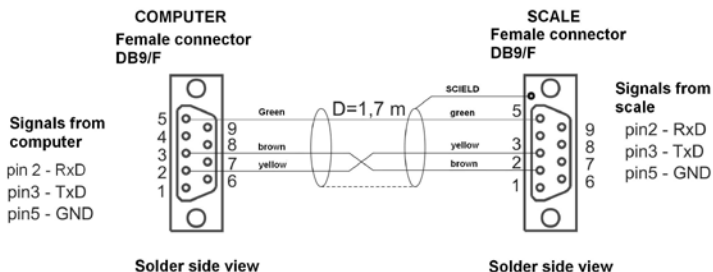

Scale – computer cable diagram for plastic casing

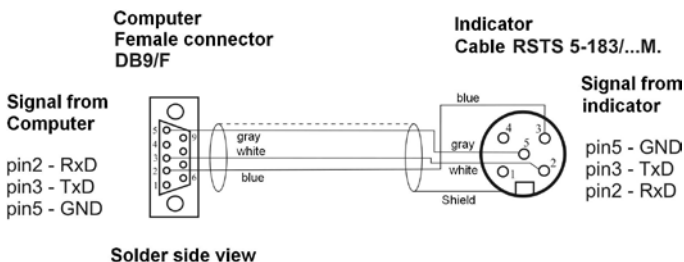

Scale – computer cable diagram

19. COMMUNICATION PROTOCOL

19.1. General information

- A. A character protocol scale-terminal has been designed for communication between RADWAG scales and external devices via RS-232 interface.
- B. It consists of commands sent from an external device to the scale and a responses from a scale.
- C. Responses are sent every time after receiving a command (reaction for any command).
- D. Using commands allows users to receive some information about the state of scale and/or influence the operation e.g.:
 - Requesting weighing results,
 - Display control.

19.2. A set of commands for RS interfaces

Commands	Description of commands
Z	Zeroing
T	Tarring
OT	Get tare
UT	Set tare
S	Send the stable result in basic unit
SI	Send the result immediately in basic unit
SU	Send the stable result in current unit
SUI	Send the result immediately in current unit
C1	Switch on continuous transmission in basic unit
C0	Switch off continuous transmission in basic unit
CU1	Switch on continuous transmission in current unit
CU0	Switch off continuous transmission in current unit
K1	Lock the scale keyboard
K0	Unlock the scale keyboard
NB	Give serial number
PC	Send all implemented commands

Notice:

1. Each command have to be terminated in CR LF;
2. The best Policy for communication is not sending another command until the former answer has been received.

19.3. Respond message format

After sending a request message you can receive:

XX_A CR LF	command accepted and in progress
XX_D CR LF	command completed (appears only after XX_A)
XX_I CR LF	command comprehended but cannot be executed
XX_^ CR LF	command comprehended but time overflow error appeared
XX_v CR LF	command comprehended but the indication below the
XX_OK CR LF	Command done
ES_CR LF	Command not comprehended
XX_E CR LF	error while executing command – time limit for stable result exceeded (limit time is a descriptive parameter of the scale)

XX - command name
_ - substitutes spaces

19.4. Command's description**19.4.1. Zeroing**

Syntax **Z CR LF**

Possible answers:

Z_A CR LF - command accepted and in progress
Z_D CR LF - command completed
Z_A CR LF - command accepted and in progress
Z_^ CR LF - command comprehended but zero range overflow appeared
Z_A CR LF - command accepted and in progress
Z_E CR LF - time limit for stable result exceeded
Z_I CR LF - command comprehended but cannot be executed

19.4.2. Tarring

Syntax: **T CR LF**

Possible answers:

- T_A CR LF** - command accepted and in progress
- T_D CR LF** - command completed
- T_A CR LF** - command accepted and in progress
- T_v CR LF** - command comprehended but tare range overflow appeared
- T_A CR LF** - command accepted and in progress
- T_E CR LF** - time limit for stable result exceeded
- T_I CR LF** - command comprehended but cannot be executed

19.4.3. Get tare value

Syntax: **OT CR LF**

Possible answers:

- OT_TARA CR LF** - command executed

Frame format:

1	2	3	4	5-6	7-15	16	17	18	19	20	21
T	O	space	stability	space	tare	space	unit			CR	LF

- Tare** - 9 characters with decimal point justified to the right
- Unit** - 3 characters justified to the left

19.4.4. Set tare value

Syntax: **UT_TARE CR LF**, where **TARE** – tare value

Possible answers:

- UT_OK CR LF** - command executed
- UT_I CR LF** - command comprehended but cannot be executed
- ES CR LF** - command not recognised (possible wrong tare format)

Notice:

This protocol uses the dot character as a decimal point for separating the decimal fraction part.

19.4.5. Send the stable result in basic unit

Syntax: **S CR LF**

Possible answers:

- S_A CR LF** - command accepted and in progress
- S_E CR LF** - time limit for stable result exceeded
- S_I CR LF** - command comprehended but cannot be executed
- S_A CR LF** - command accepted and in progress
- MASS FRAME** - mass value in basic unit is returned

Frame format:

1	2-3	4	5	6	7-15	16	17	18	19	20	21
S	space	stability	space	sign	mass	space	unit			CR	LF

Example:

S CR LF – computer command

S _ A CR LF - command accepted and in progress

S _ _ _ _ - _ _ _ _ _ 8 . 5 _ g _ _ CR LF – command done,
mass value in basic unit is returned.

19.4.6. Send the result immediately in basic unit

Syntax: **SI CR LF**

Possible answers:

- SI_I CR LF** - command comprehended but cannot be executed at the moment
- MASS FRAME** - mass value in basic unit is returned

Frame format:

1	2	3	4	5	6	7-15	16	17	18	19	20	21
S	I	space	stability	space	sign	mass	space	unit			CR	LF

Example:

S I CR LF – computer command

S I _ ? _ _ _ _ _ 1 8 . 5 _ k g _ CR LF - command done, mass value in basic unit is returned immediately.

19.4.7. Send the stable result in current unit

Syntax: **SU CR LF**

Possible answers:

SU_A CR LF - command accepted and in progress

SU_E CR LF - timeout while waiting for stable results

SU_I CR LF - command comprehended but cannot be executed

SU_A CR LF - command accepted and in progress

MASS FRAME - mass value in current unit is returned

Frame format:

1	2	3	4	5	6	7-15	16	17	18	19	20	21
S	U	space	stability	space	sign	mass	space	unit			CR	LF

Example:

S U CR LF – computer command

S U _ A CR LF - command accepted and in progress

S U _ _ _ - _ _ 1 7 2 . 1 3 5 _ N _ _ CR LF - command done, mass value in current unit is returned.

19.4.8. Send the result immediately in current unit

Syntax: **SUI CR LF**

Possible answers:

- SUI CR LF** - command comprehended but cannot be executed
- MASS FRAME** - mass value in current unit is returned immediately

Frame format:

1	2	3	4	5	6	7-15	16	17	18	19	20	21
S	U	I	stability	space	sign	mass	space	unit			CR	LF

Example:

SUI CR LF – computer command

SUI? _ - _ _ _ 5 8 . 2 3 7 _ k g _ CR LF - command executed and mass returned

19.4.9. Switch on continuous transmission in basic unit

Syntax: **C1 CR LF**

Possible answers:

- C1_I CR LF** - command comprehended but cannot be executed
- C1_A CR LF** - command comprehended and in progress
- MASS FRAME** - mass value in basic unit is returned

Frame format:

1	2	3	4	5	6	7-15	16	17	18	19	20	21
S	I	space	stability	space	sign	mass	space	unit			CR	LF

19.4.10. Switch off continuous transmission in basic unit

Syntax: **C0 CR LF**

Possible answers:

- C0_I CR LF** - command comprehended but cannot be executed
- C0_A CR LF** - command comprehended and executed

19.4.11. Switch on continuous transmission in current unit

Syntax: **CU1 CR LF**

Possible answers:

CU1_I CR LF - command comprehended but cannot be executed

CU1_A CR LF - command comprehended and in progress

MASS FRAME - mass value in current unit is returned

Frame format:

1	2	3	4	5	6	7-15	16	17	18	19	20	21
S	U	I	stability	space	sign	mass	space	unit			CR	LF

19.4.12. Switch off continuous transmission in current unit

Syntax: **CU0 CR LF**

Possible answers:

CU0_I CR LF - command comprehended but cannot be executed

CU0_A CR LF - command comprehended and executed

19.4.13. Lock the scale keyboard

Syntax: **K1 CR LF**

Possible answers:

K1_I CR LF - command comprehended but cannot be executed

K1_OK CR LF - command executed

Caution:

This command is not remembered after restart

19.4.14. Unlock the scale keyboard

Syntax: **K0 CR LF**

Possible answers: **K0_OK CR LF** – command in progress

19.4.15. Give serial number

Syntax: **NB CR LF**

Possible answers:

NB_A_”Factory number” CR LF - command comprehended, scale serial number is given in return

NB_I CR LF - command comprehended but cannot be executed

”Factory number” – parameter specifying scales serial number, it is returned in between inverted comas.

Example:

NB CR LF – command from a computer

NB_A_”123456” CR LF – scales serial number - 123456

19.4.16. Send all implemented commands

Syntax: **PC CR LF**

Possible answers:

PC_->_Z,T,S,SI,SU,SUI,C1,C0,CU1,CU0,K1,K0,OT,UT,NB,PC

– command executed, the indicator have sent all the implemented commands.

19.5. Manual printouts / automatic printouts

Users can general manual or automatic printouts from the scale.

- Manual printouts can be performed after loading the pan

and stabilizing indication by pressing .

- Automatic printouts can be performed only after loading the pan and stabilizing indication.

Notice:

If a scale is verified printouts of immediate values are blocked.

Format frame:

1	2	3	4 -12	13	14	15	16	17	18
stability	space	sign	mass	space	unit			CR	LF

Stability character [space] if stable
[?] if not stable
[^] if an indication over the range
[v] if fan indication below the range

sign [space] for positive values or
[-] for negative values

mass 9 characters justified to the right

unit 3 characters justified to the left

command 3 characters justified to the left

Example 1:

_____ **1 8 3 2 . 0 _ g _ _ CR LF** – the printout generated from the scale after pressing ENTER/PRINT.

Example 2:

? _ - _____ **2 . 2 3 7 _ l b _ CR LF** - the printout generated from the scale after pressing ENTER/PRINT.

Example 3:

^ _____ **0 . 0 0 0 _ k g _ CR LF** - the printout generated from the scale after pressing ENTER/PRINT.

19.6. Continuous transmission

The indicator can work in a continuous transmission mode. It can be switched on or off in parameters or using RS232 commands.

The frame format sent by the indicator in case of setting <P2.Prnt> to **CntA**:

1	2	3	4	5	6	7-15	16	17	18	19	20	21
S	I	space	stability	space	sign	mass	space	Unit			CR	LF

- Stability character** [space] if stable
[?] if not stable
[^] if an indication over the range
[v] if fan indication below the range
- sign** [space] for positive values or
[-] for negative values
- mass** 9 characters justified to the right
- unit** 3 characters justified to the left
- command** 3 characters justified to the left

The frame format sent by the indicator in case of setting <P2.Prnt> to **Cntb**:

1	2	3	4	5	6	7-15	16	17	18	19	20	21
S	U	I	stability	space	sign	mass	space	unit			CR	LF

19.7. Configuring printouts

General information

If some information included are redundant or not sufficient and there is a necessity of changes one can design their own protocol format in **EDYTOR WAG** computer program. This piece of software is accessible in: <http://www.radwag.com>

20. ERROR COMMANDS

- Err2** - Value beyond the zero range
- Err3** - Value beyond the tare range
- Err4** - Calibration mass or start mass beyond the acceptable range ($\pm 1\%$ for weight, ± 10 for start mass)
- Err5** - Mass of a single piece lower than the scale division
- Err8** - Exceeded the time for tarring, zeroing, start mass adjustment or span adjustment
- Err9** - Time for internal weight lifting/dropping down exceeded (refers to WLC.../C/2 scales)
- NULL** - Zero value from the AD converter
- FULL2** - Measurement range overflow
- LH** - Start mass error, the mass on the weighing platform is beyond the acceptable range (-5% to +15% of start mass)
- 5-FULL** - Display range overflow in totalizing

Notice:

1. Errors: **Err2, Err3, Err4, Err5, Err8, Err9, null**, that appear on the display are also signalled by a short beep sound (about 1 sec.);
2. Error **FULL2** that appears on the display is also signalled by a continuous sound until the cause of error disappears.

21. TROUBLE SHOOTING

Problem	Cause	Solution
Turning on does not work	Discharged batteries.	Connect to mains or change batteries
	No batteries (not installed or improperly installed)	Check the correctness of installation (polarization)
The scale turns off automatically	„t1” set to „YES” (Power save)	In „othr” submenu change „5.4 t1” to „no”
After turning on „LH” message on the display	Loaded weight pan during powering up	Unload the pan. Then the scale will indicator zero.

22. ADDITIONAL EQUIPMENT

Accessories:

- KAFKA printer cable for PUE C/31H, PUE C/31H/Z - **P0253**,
- Computer cable for PUE C/31H, PUE C/31H/Z - **P0259**,
- EPSON printer cable for PUE C/31H, PUE C/31H/Z - **P0261**,
- Power cord for car lighter 12V DC for PUE C/31H/Z - **K0042**,
- Thermal printer - **KAFKA**,
- Dot matrix printer - **EPSON**,
- Additional display in stainless metal housing for PUE C/31H, PUE C/31H/Z - **WD- 4/3** (accessible with balance as complete set only),
- Large size display (2") for PUE C/31H, PUE C/31H/Z - **WWG-2**,
- Current loop in metal housing PUE C/31H, PUE C/31H/Z - **AP2-3** (accessible with balance as complete set only),
- RS232 / Ethernet converter for PUE C/31 H, PUE C/31H/Z - **KR-04**,
- Anti-dust case for Epson printer,
- A rack for PUE C/31, PUE C/31H or PUE C/31H/Z indicator,
- A table for a scale (3 versions, for WPT/H3, WPT/H4 and WPT/H5),
- Stainless steel anti-vibration table - **SAP/N**,
- Inroads for low profile scales,
- Roller table.

Computer programs:

- "EDYTOR WAG" computer program,
- "RAD-KEY" computer program,
- "PW-WIN" computer program.



RADWAG BALANCES AND SCALES
ADVANCED WEIGHING TECHNOLOGIES

