

Susceptometer

SM-UYA 4Y
SM-MYA 4Y

USER MANUAL

IMMU-99-01-08-18-EN



Congratulations and thank you for selecting RADWAG product.
You have purchased a device that has been designed and manufactured to give you years of service.
Please read this User Manual carefully, this shall guarantee reliable operation.

AUGUST 2018

CONTENTS

| | |
|---|-----------|
| 1. GENERAL INFORMATION | 6 |
| 1.1. Dimensions | 6 |
| 1.2. Connectors Arrangement | 6 |
| 1.3. Intended Use | 7 |
| 1.4. Precautions | 7 |
| 1.5. Warranty Conditions | 8 |
| 1.6. Supervision Over Metrological Parameters | 8 |
| 1.7. User Manual Significance | 8 |
| 1.8. Operator Training | 8 |
| 2. TRANSPORT AND STORAGE | 9 |
| 2.1. Delivery Check | 9 |
| 2.2. Packaging | 9 |
| 3. UNPACKING AND INSTALLATION | 9 |
| 3.1. Place of Use | 9 |
| 3.2. Unpacking | 10 |
| 3.3. Standard Delivery Components List | 11 |
| 3.4. Workroom and Basic Operation Guidelines | 11 |
| 3.5. Connecting the Device to the Mains | 13 |
| 3.6. Temperature Stabilization Time | 13 |
| 3.7. Connecting Peripheral Equipment | 13 |
| 4. MAINTENANCE | 14 |
| 5. START-UP | 15 |
| 6. KEYS | 16 |
| 7. PROGRAM | 17 |
| 8. HOME SCREEN | 18 |
| 9. LOG IN OPERATION | 19 |
| 10. OPERATING THE MENU | 20 |
| 10.1. Navigation | 20 |
| 10.2. Return to the Magnetism Mode | 20 |
| 11. ADJUSTMENT | 21 |
| 11.1. Internal Adjustment | 21 |
| 11.2. External Adjustment | 21 |
| 11.3. User Adjustment | 22 |
| 11.4. Adjustment Test | 22 |
| 11.5. Automatic Adjustment | 22 |
| 11.6. Automatic Adjustment Time | 22 |
| 11.7. Scheduled Adjustments | 22 |
| 11.8. Report Printout | 24 |
| 11.9. GLP Project | 24 |
| 11.10. Adjustment History | 25 |
| 12. OPERATORS | 26 |
| 13. ADMINISTRATOR PANEL | 27 |

| | |
|--|-----------|
| 13.1. Password Settings | 27 |
| 13.2. Operator Accounts Settings | 28 |
| 13.3. Permissions Management | 29 |
| 14. PROFILES..... | 31 |
| 14.1. Creating a Profile | 31 |
| 14.2. Profile Structure | 32 |
| 14.2.1. Settings | 33 |
| 14.2.2. Working Modes | 33 |
| 14.2.3. Readout | 33 |
| 14.2.4. Units..... | 34 |
| 15. WORKING MODES - GENERAL INFORMATION | 35 |
| 15.1. Working Modes | 35 |
| 15.2. Working Mode Parameters..... | 36 |
| 15.3. Quick Access Buttons, Proximity Sensors..... | 36 |
| 15.3.1. Proximity Sensors | 36 |
| 15.4. Information | 37 |
| 15.5. Printouts | 37 |
| 15.6. PROFILES..... | 38 |
| 16. WEIGHING | 39 |
| 16.1. Weighing Unit Selection | 39 |
| 16.2. Good Weighing Practice..... | 39 |
| 16.3. Level Status | 40 |
| 16.4. Zeroing | 40 |
| 16.5. Taring..... | 40 |
| 16.6. Use of Air Buoyancy Compensation Factor | 41 |
| 16.7. Additional Parameters for a Weighing Process | 44 |
| 16.8. Minimum Sample Weight..... | 46 |
| 16.9. Cooperation with Titrators | 48 |
| 16.10. Ambient Conditions - Vibrations | 49 |
| 17. MAGNETISM..... | 52 |
| 18. DATABASES..... | 55 |
| 18.1. Database Connected Operations..... | 55 |
| 18.2. Weighing Records..... | 56 |
| 18.3. Customers..... | 57 |
| 18.4. Susceptibility: Reports | 57 |
| 18.5. Minimum sample weight..... | 58 |
| 18.6. Ambient Conditions | 59 |
| 18.7. Warehouses..... | 60 |
| 18.8. Printouts | 60 |
| 18.9. Universal Variables | 62 |
| 18.10. Databases Management | 62 |
| 18.10.1. Export Weighing Database to a File..... | 62 |
| 18.10.2. Delete Databases | 64 |
| 18.10.3. Delete Weighings and Reports..... | 64 |
| 19. COMMUNICATION | 65 |
| 19.1. RS 232 Settings | 65 |
| 19.2. ETHERNET Settings | 65 |
| 19.3. Wi-Fi Settings | 65 |

| | |
|--|------------|
| 19.4. TCP Settings | 67 |
| 20. PERIPHERALS | 67 |
| 20.1. Computer | 67 |
| 20.2. Printer | 68 |
| 20.3. Barcode Scanner | 69 |
| 20.3.1. Barcode Scanner Port | 70 |
| 20.3.2. Prefix/Suffix..... | 70 |
| 20.3.3. Field Selection | 70 |
| 20.3.4. Test..... | 72 |
| 20.4. Transponder Card Scanner | 72 |
| 20.5. Additional Display..... | 73 |
| 20.6. Ambient Conditions Module | 73 |
| 20.7. Automatic Feeder | 73 |
| 21. INPUTS/OUTPUTS..... | 74 |
| 22. MISCELLANEOUS PARAMETERS..... | 75 |
| 22.1. Interface Language..... | 75 |
| 22.2. Date and Time | 75 |
| 22.3. „Beep“ Sound | 77 |
| 22.4. Volume | 77 |
| 22.5. Sleep Mode..... | 77 |
| 22.6. Display Brightness..... | 77 |
| 22.7. Touch Panel Calibration..... | 77 |
| 22.8. Vibrations Detection | 78 |
| 22.9. Level Control | 78 |
| 22.10. Proximity Sensors Sensitivity..... | 78 |
| 22.11. Proximity Sensors Timeout..... | 79 |
| 22.12. Autotest..... | 79 |
| 22.13. Start-Up Logo..... | 83 |
| 22.14. Export of System Events | 83 |
| 23. UPDATE..... | 83 |
| 24. ABOUT | 84 |
| 25. VIDEOS | 84 |
| 26. COMMUNICATION PROTOCOL | 85 |
| 26.1. List of Commands..... | 85 |
| 26.2. Response Format | 87 |
| 26.3. Manual Printout / Automatic Printout | 102 |
| 27. CONNECTING PERIPHERALS | 102 |
| 28. ERROR MESSAGES..... | 103 |
| 29. ADDITIONAL EQUIPMENT | 104 |
| 30. APPENDIX A - Printout Variables | 104 |
| 30.1. Variables List | 104 |
| 30.2. Variables Formatting..... | 106 |
| 31. APPENDIX B – Programmable Buttons List | 108 |
| 32. APPENDIX E - Communication with Barcode Scanner | 109 |
| 33. APPENDIX F – Menu Structure | 109 |

1. GENERAL INFORMATION

1.1. Dimensions

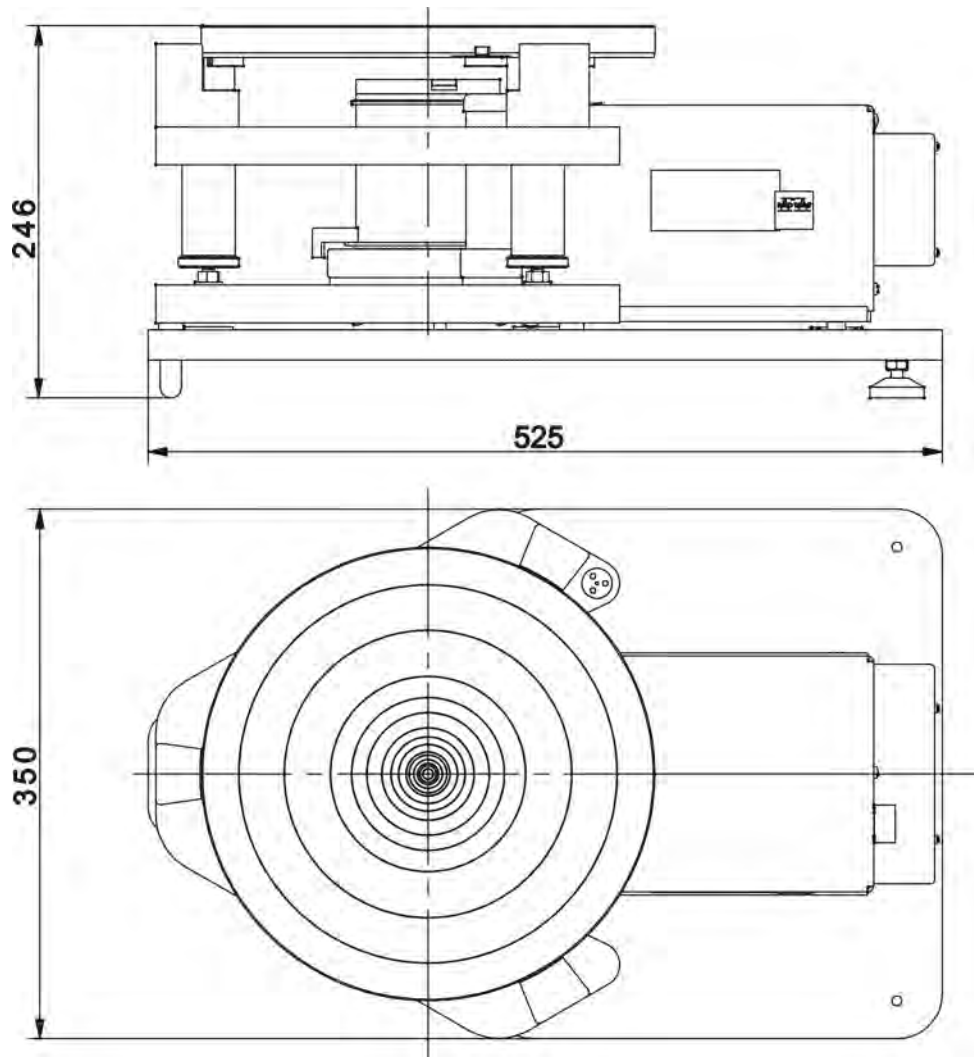

Indicator

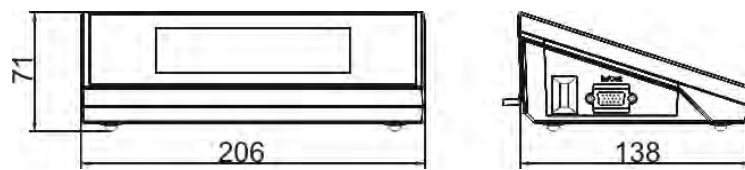

1.2. Connectors Arrangement

Connectors arrangement:



1 – Ethernet RJ45 connector
2 – RS232 (COM1) connector

4 – I/O, RS232 (COM2) connector

3 – USB connector

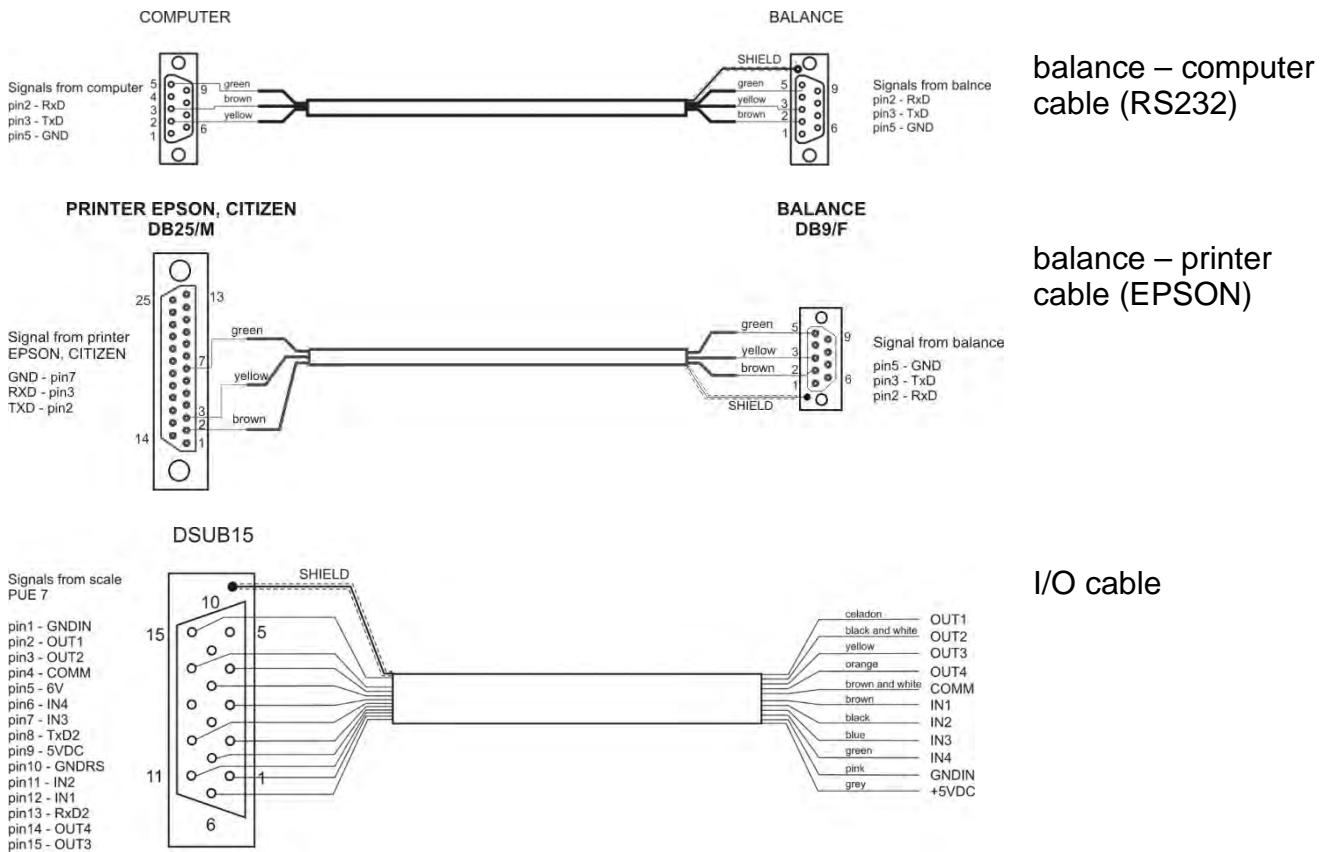

Caution: "Ethernet – weighing device" cable is a standard network cable terminated with RJ45 connectors on both ends.

1.3. Intended Use

SM susceptometer enables carrying out measurements of magnetic susceptibility and magnetization of mass standards and weights of class E1 and lower in accordance with OIML R111. The susceptometer is intended for accurate measurements in laboratory conditions.

1.4. Precautions

- Prior the first use, carefully read this User Manual. Use the device only as intended.
- Do not operate the touch panel using sharp-edged tools (knife, screwdriver, etc.).
- Place weighed loads in the centre of the weighing pan.
- Load the weighing pan with loads of gross weight which does not exceed the maximum capacity.
- Mind not to leave heavy loads on the weighing pan for longer periods of time.
- In case of damage, immediately unplug the device from the mains.
- Scales to be decommissioned must be decommissioned in accordance with valid legal regulations.
- Do not use the weighing instrument in areas endangered with explosion. The balance is not intended to be operated in hazardous areas.

1.5. Warranty Conditions

- A. RADWAG feels obliged to repair or exchange all elements that appear to be faulty by production or by construction.
- B. Defining defects of unclear origin and means of their elimination can only be realized with assistance of the manufacturer and user representatives.
- C. RADWAG does not bear any responsibility for damage or loss resulting from unauthorized or inadequate performing of production or service processes.
- D. The warranty does not cover:
 - mechanical damage caused by product exploitation other than intended, damage of thermal and chemical origin, damage caused by lightning, overvoltage in the power network or other random event,
 - damage caused by product exploitation other than intended,
 - mechanical damage, if service claims removing or destroying protective stickers which secure the device's housing against unauthorized access,
 - damage caused by liquids, water and natural wear,
 - damage caused by inappropriate setting or by electrical wiring failures,
 - damage caused by overloading of the mechanical measuring system,
 - inappropriate cleaning habits.
- E. Loss of warranty takes place if:
 - a repair is carried out outside RADWAG authorized service point,
 - service claims intrusion into mechanical or electronic construction by unauthorized people,
 - other than original version of the operating system is installed in a balance,
 - the device does not bear security seal stickers.
- F. For detailed warranty conditions read the warranty certificate.

1.6. Supervision Over Metrological Parameters

Metrological parameters need to be checked in determined time intervals. Inspection frequency depends on ambient conditions in which the weighing instrument is operated, kind of carried out processes and adopted quality management system.

1.7. User Manual Significance

Even if you are experienced and have already worked with this type of weighing instrument, you are still obliged to read this user manual carefully prior switching the device on. This user manual contains crucial information for correct operation of the module. As long as you follow the guidelines your balance operation is correct and reliable.

1.8. Operator Training

The weighing device must be utilized and supervised only by personnel who have been trained to use such type of a weighing device.

2. TRANSPORT AND STORAGE

2.1. Delivery Check

Upon delivery it is necessary to check the package and the device, make sure that your package bears no signs of damage. Otherwise contact the manufacturer's representative.

2.2. Packaging

Keep all package elements should your device be transported in the future. Remember that only original packaging can be used for shipping purposes. Prior packing, uncouple any cables, remove any separable components (weighing pan, shields, inserts). The device components shall be packed into an original packaging, thus being protected against potential damage during transportation.

3. UNPACKING AND INSTALLATION

3.1. Place of Use

- Operate the device in a workroom free of vibrations and shakes, where there are no air drafts nor dust.
- Make sure that the ambient temperature ranges between: +10 °C ÷ +40 °C,
- Make sure that the relative humidity is not higher than 80%,
- Make sure that the temperature changes slowly in the course of operation.
- Place the weighing instrument either on a robust-design table or on a wall bracket, which is both distant from heat sources and unsusceptible to vibrations.

3.2. Unpacking

Cut the adhesive tape. Take the device components and the wooden box with the device out of the packaging. Unscrew 3 screws fixing the device to the box and take them out. Screw 2 feet and base bracket into device's base.

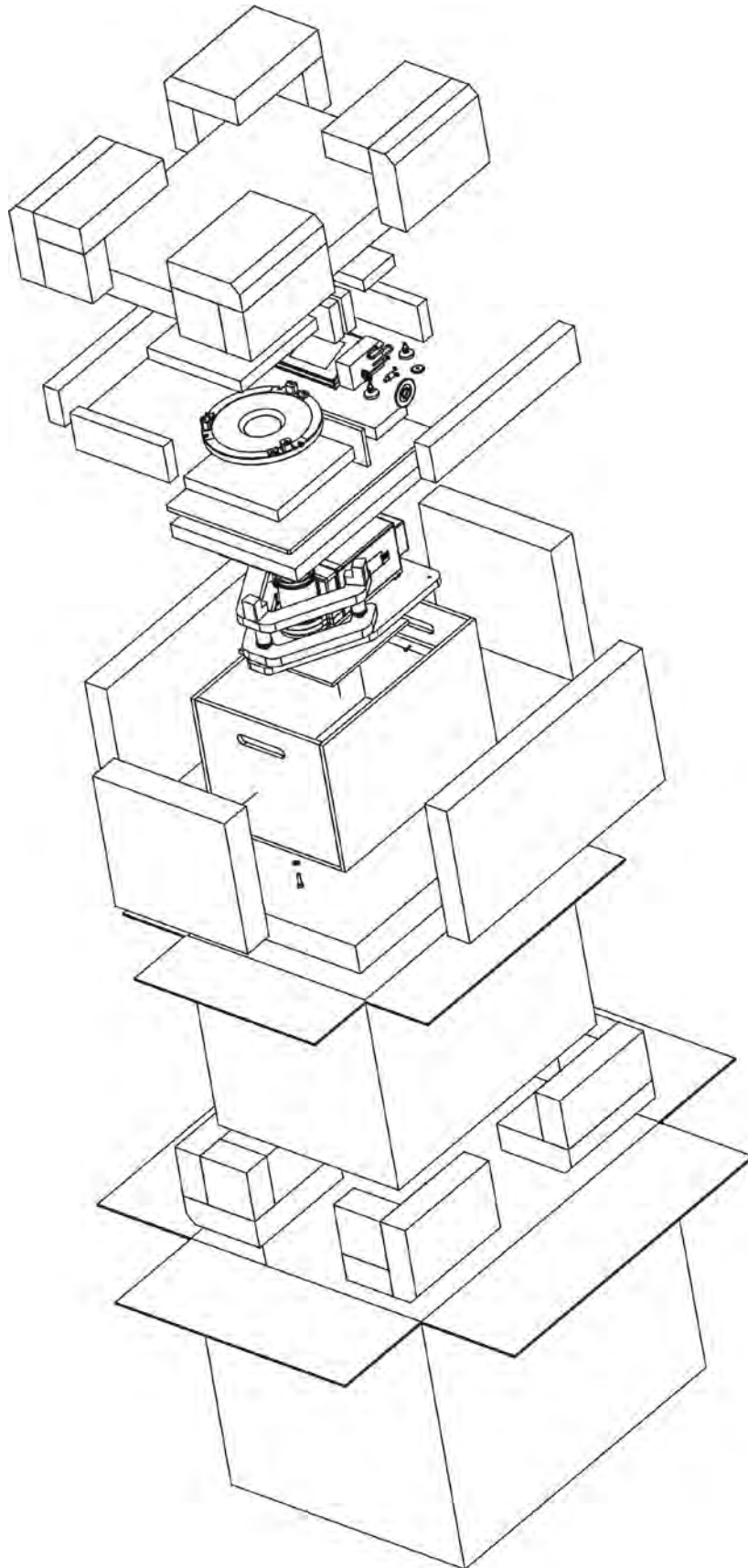

3.3. Standard Delivery Components List

- Balance
- Device feet
- Base support
- Mass standard support
- Mass standard support plate
- Draft shield
- Magnet
- Magnet support
- Weighing pan
- Anti-draft chamber glass lid
- Power supply
- User manual - CD version

3.4. Workroom and Basic Operation Guidelines

Put the weighing instrument in the place of use, on stable base, and install the weighing pan. Follow the below procedure.

Steps:

1. Place the balance (1) at its workstation.
2. Install the draft shield (2).
3. Install the magnet support (4).
4. Place the magnet (5) in the support's socket.
5. Install the anti-draft chamber glass lid (6).
6. Install the mass standard support (7) on the devices base by assembling bracket pin into corresponding base sockets.
7. Install the mass standard support plate (8) by assembling support's pins into corresponding plate sockets depending on tested mass standard (see description in section 17).

If the device is to be used to weight mass standards and other samples, dismantle mass standard support plate (8), mass standard support (7), magnet (5) and magnet support (4). Next, install weighing pan (3) in the weighing chamber in the place where magnet support was previously installed.

Such prepared susceptometer can work as a balance.

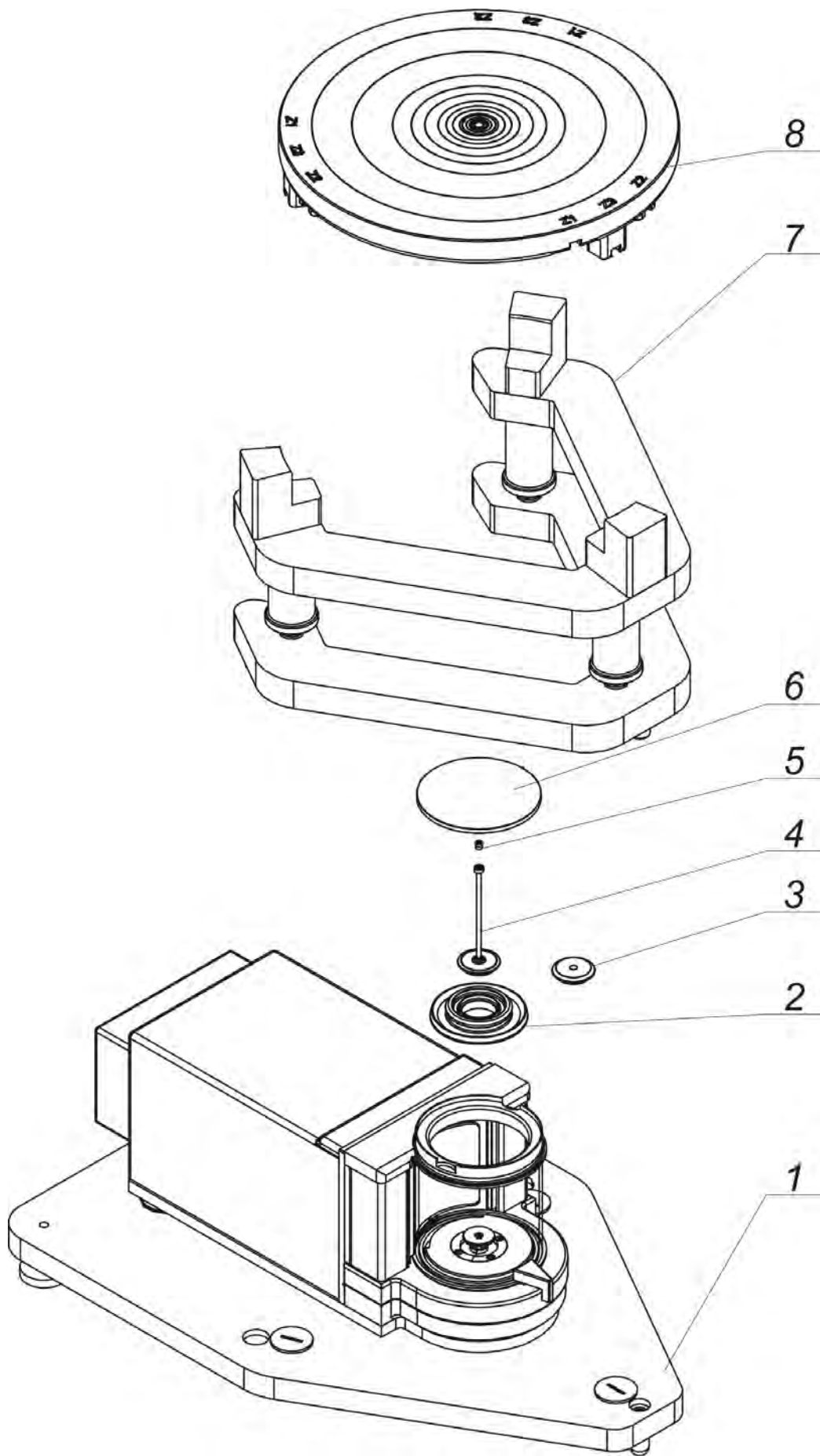

3.5. Connecting the Device to the Mains

The weighing device can be connected to the mains only with a power supply that comes standard with a particular model. Nominal voltage of the power supply (specified on the power supply data plate) has to be compatible with the mains nominal voltage.

Plug the balance to the mains – connect the power adapter to the socket, next connect its connector to interface located at the back of the balance housing.

3.6. Temperature Stabilization Time

Prior to measuring processes start, it is necessary to wait until the platform reaches thermal stabilisation.

Balances stored in much lower temperatures, than the workroom temperature, before being plugged to the mains (e.g. during winter period) must be subjected to thermal stabilisation. The thermal stabilisation period takes about 12 hours. During the thermal stabilization, the indications on the screen may change. Potential workroom temperature change shall occur gradually and slowly in the course of the weighing instrument operation.

3.7. Connecting Peripheral Equipment

Use only accessories and peripheral equipment recommended by the manufacturer. The balance must be disconnected from the mains before connecting or disconnecting any peripherals (printer, PC computer, computer keyboard of USB type, additional display). Upon connecting the peripherals, plug the module to the mains.

4. MAINTENANCE

CAUTION:

Cleaning the weighing pan or the magnet support while still installed may cause damage of the measuring system.

1. Uninstall the weighing pan and other detachable components depending on balance type (refer to section: *UNPACKING AND INSTALLATION*). Be careful while detaching the components so as not to cause any damages to the mechanism. Remove the weighing pan of a microbalance using tweezers.
2. Using handheld vacuum cleaner remove dust from the weighing chamber (recommended for microbalances).

Cleaning anti-draft chamber panes:

Select dissolvent depending on a dirt. Never soak the glass panes in alkaline solutions since they interact with glass and may cause damage. Do not use products containing abrasive substances.

For organic dirt use acetone first, next use water or detergent. For other than organic dirt use diluted acid solutions (soluble salts of hydrochloric or nitric acid) or base solutions (ammonium or sodium base).

To remove ACIDS use protophilic solvent (sodium carbonate), to remove BASE use protogenic solvent (mineral acid of various concentration).

In case of heavy contamination use brush or detergent nevertheless avoid detergents containing large and hard molecules which could potentially scratch glass panes.

At the end of the cleaning process rinse the pane using running water first, distilled next.

Use soft brush with wooden or plastic handle exclusively in order to avoid risk of scratches. Do not use wire brush.

Rinsing is a necessary cleaning process stage allowing to remove remaining soap, detergents and other cleansers from the panes prior their reinstallation.

At the end of the cleaning process rinse the pane using running water first, distilled next.

Avoid drying the panes either using paper towel or forced air circulation since some fibres, grains or contamination of other type could permeate into the panes thus causing weighing errors.

One shall not use driers when drying measuring glass tools.

It is a frequent treatment to leave glass components on a rack to dry.

Cleaning powder-coated components:

For preliminary cleaning stage you need running water or wet sponge featuring large holes, this will help you to remove loose, heavy dirt.

Do not use products containing abrasive substances.

Next, using cloth and cleanser-water solution (soap, dishwashing liquid) gently rub the cleaned surface.

Avoid using cleanser without water since it may result with damage of the cleaned surface, please mind that large amount of water mixed with cleanser is a must.

Cleaning aluminium components:

While cleaning aluminium components use products acid by nature, e.g. spirit vinegar, lemon. Do not use products containing abrasive substances. Avoid using hard brush, this may cause scratches. It is recommended to use microfiber cloth.

While polishing the surface use circular movements. Use clean, dry cloth.

Cleaning stainless steel components:

Avoid using cleansers containing any corrosive chemicals, e.g. bleach (including chlorine). Do not use products containing abrasive substances. Always remove the dirt using microfibre cloth to avoid damage of protective coating.

In case of a daily maintenance:



- 1. Remove the dirt using cloth dipped in warm water.*
- 2. For best results, add a little dishwashing detergent.*

Cleaning ABS components:

To clean dry surfaces and avoid smudging, use clean non-colouring cloths made of cellulose or cotton. You can use a solution of water and detergent (soap, dishwashing detergent, glass cleaner). Gently rub the cleaned surface and let it dry. Repeat the cleaning process if needed.



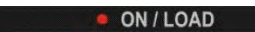

In case of hard to remove contamination, e.g.: residues of adhesive, rubber, resin, polyurethane foam etc., you can use a special cleaning agents based on a mixture of aliphatic hydrocarbons that do not dissolve plastics. Before using the cleanser for all surfaces we recommend carrying out tests. Do not use cleansers containing abrasive substances.

5. START-UP

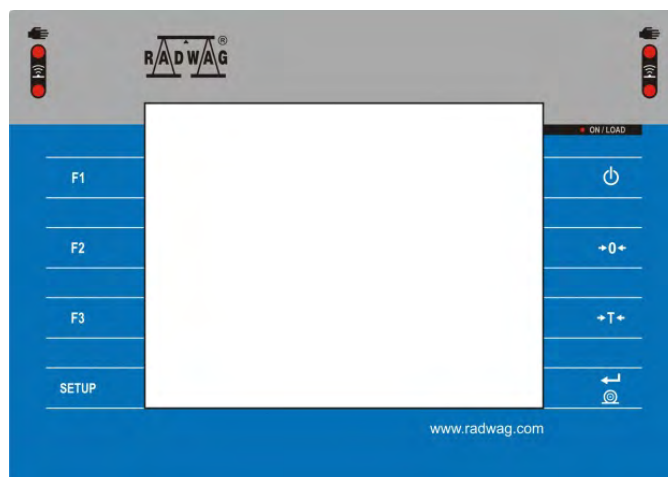
- Connect the power supply to the mains, ON/LOAD  diode on the operation panel lights up.
- Press  key located on the top of the operation panel. Within a few seconds the OS Windows and RADWAG software start loading, it is signalled by flickering ON/LOAD red diode.
- Upon completed start-up the home screen is displayed automatically.
- The balance runs with no user logged in. In order to start operation it is necessary to log in (for detailed logging procedure read later sections of this user manual).

6. KEYS















| Key | Description |
|--|---|
|  | Press to switch the balance ON/OFF |
|  | Press to zero the balance |
|  | Press to tare the balance |
|  | Press to send measurement to a printer or a computer |
| SETUP | Press to enter the menu |
| F1 | Press to select working mode; programmable key |
| F2 | Press to select profile; programmable key |
| F3 | Press to carry out an internal adjustment; programmable key |

7. PROGRAM

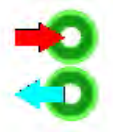
Program menu is divided into function groups. Function group is a group of interrelated parameters. For detailed description of each menu group read later sections of this user manual.

Menu - Function Groups:

To access the menu press SETUP function key or  button located in the bottom part of the display. The menu comprises parameters related to balance settings, functions and profiles.

| | | |
|--|---|---|
|  ADJUSTMENT |  OPERATORS |  PROFILES |
|  DATABASES |  COMMUNICATION |  PERIPHERALS |
|  INPUTS/OUTPUTS |  ADMINISTRATOR PANEL |  MISCELLANEOUS |
|  AMBIENT CONDITIONS |  UPDATE |  ABOUT (system info) |
|  VIDEOS | | |

8. HOME SCREEN

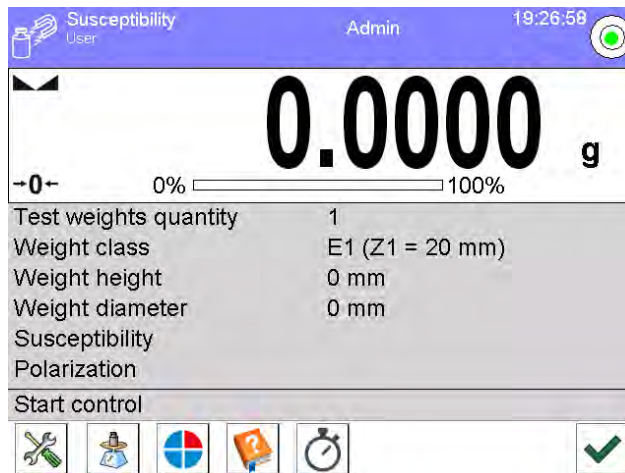

The home screen features 4 sections:

- Top section displaying data on active working mode, logged in user, date, time, computer connection status and level status.



- Section presenting the weighing result and a current measuring unit.

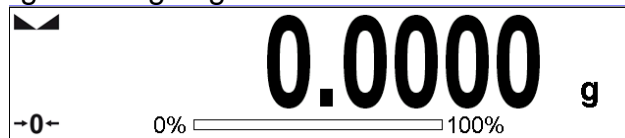

- Section comprising supplementary information on currently performed operations (grey background).

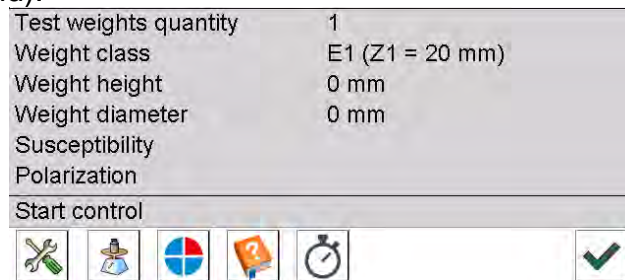

CAUTION:

Data contained in this workspace is freely configurable. For detailed instruction read section 15.4 of this user manual.

- Section comprising on-screen function buttons:



CAUTION:

The operator can define the on-screen function buttons. For detailed instruction read section 15.3 of this user manual.

9. LOG IN OPERATION

In order to access operator-related parameters and in order to edit databases, you need to log in as an operator with **<Administrator>** permissions level.

First log in operation:

- Go to home screen, press **<Log in>** button, wait for the operators database and **<Admin>** entry to open.
- Press **<Admin>** entry, Wait for the on-screen keyboard with a password box to open.
- Enter „1111” password and press  button to confirm.
- The home screen is displayed, **<Log in>** sign is replaced by **<Admin>** sign.
- When logged, add operators and set permissions (for detailed procedure read section 12 and 13).

While logging in again, select an operator from the list and enter the password; the program initiates operation with permissions set for the selected operator.















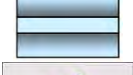

Log Out operation:

- Go to home screen, press logged operator name, wait for the operators database to open.
- Press **<Log out>** entry (1st position on the operators list).
- Home screen is displayed, admin name is replaced with **<Log in>** entry.

10. OPERATING THE MENU

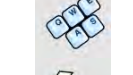
Operation of device program menu is intuitive. The touch panel makes the software operation easy. By pressing an on-screen button or any field, you activate respective function/operation.

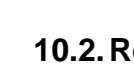

10.1. Navigation

| | | | |
|---|----|---|--|
|  | or |  | Press to enter the main menu. |
|  | | | Press to scroll the menu 'up' |
|  | | | Press to scroll the menu 'down' |
|  | | | Press to scroll the menu 'up-down' fast |
|  | | | Press to confirm modification |
|  | | | Press to exit, function remains unmodified |
|  | | | Press to add a new record to a database |
|  | | | Press to search for a particular record in a database by date |
|  | | | Press to search for a particular record in a database by name |
|  | | | Press to search for a particular record in a database by code |
|  | | | Press to print database entries |
|  | | | Press to clear edit box content |
|  | | | Press to switch the on-screen keyboard on/off |
|  | | | Press to read printout template saved to *.lb file (the button becomes active upon connecting the USB flash drive) |
|  | | | Press to select printout template variables out of the list |
|  | | | Press to go one menu level up |

10.2. Return to the Magnetism Mode

Modifications introduced into balance memory, are automatically saved upon return to weighing operation.

Procedure:

- Press  button repeatedly, keep pressing until you see the home screen.
- Press  button, the home screen is displayed immediately.

11. ADJUSTMENT

The module features automatic internal adjustment system which ensures correct measurement accuracy. <ADJUSTMENT> menu contains functions controlling operation of module adjustment process.

11.1. Internal Adjustment

Internal adjustment is carried out by means of an internal adjustment weight. <Internal adjustment> button, when pressed, automatically triggers adjustment process. Upon adjustment process completion, a respective message is displayed informing on the process status.





CAUTION:

Balance adjustment procedure requires stable conditions (no air drafts, no vibrations), in the course of adjustment the weighing pan must be unloaded.

11.2. External Adjustment

External adjustment is carried out using an external mass standard of the right accuracy and weight value, which value depends on weighing device model and capacity. The external adjustment procedure is a semi-automatic process, particular stages of which are signalled with on-screen prompts.

Procedure:

- Enter <Adjustment> submenu, next select  < External adjustment> parameter.
- Message to remove weight is displayed. Unload the weighing pan and press  button. The balance determines start mass, message: **Start mass determination** is displayed.
- Upon completed start mass determination, message ordering you to load the weighing pan is displayed. Load the weighing pan with weight of respective mass value and press  button.
- Upon completed procedure, unload the weighing pan and press  button to confirm. Balance returns to the weighing process.

11.3. User Adjustment

User adjustment can be carried out using any adjustment weight mass of which ranges between 0.15 Max and Max. User adjustment and external adjustment procedures are likewise with one exception, before user adjustment start, an edit box for entering mass of the used adjustment weight is opened.

In order to start user adjustment, enter <Adjustment> submenu and select  User adjustment> option. Then follow the displayed prompts.

11.4. Adjustment Test

<Adjustment test> function enables comparing the result of an internal automatic adjustment with the value recorded in mass comparator factory parameters. The comparison is used for determining balance sensitivity drift over time.

11.5. Automatic Adjustment

Enter this menu to specify conditions initiating an automatic adjustment. Options:

- None – automatic adjustment inactive.
- Time – adjustment takes place in time intervals declared in menu <Automatic adjustment time> (11.6),
- Temperature – adjustment is triggered by temperature change.
- Both – adjustment is triggered by both, temperature changes and time.

11.6. Automatic Adjustment Time

 <Automatic adjustment time> parameter determines time interval between successive automatic internal adjustments. The time interval is declared in hours and ranges between 1 and 12 hours.

To set time interval for automatic adjustment:

- Select <Automatic adjustment time> option.
- Using displayed menu, select appropriate time interval (given in hours) which is to elapse between the most recent adjustment and activation of the following automatic internal adjustment.

11.7. Scheduled Adjustments

 <Scheduled adjustments> parameter allows you to precisely specify time for adjustment performance and interval between successive adjustments. The parameter is not connected with automatic adjustment and its criteria (time, temperature). You can schedule when internal and external adjustment are to be performed. In order to design schedule for external adjustment, it is necessary to record mass standards for adjustment performance into balance memory.

Procedure:

Prior setting adjustment schedule, enter data of mass standards intended for external adjustment performance.

Enter operator menu, select <Adjustment> submenu and find  Adjustment weights> parameter. Enter weight data:



Enter operator menu, select <Adjustment> submenu and find <Scheduled adjustments> parameter.



Enter <Scheduled adjustments> parameter, wait for 'Scheduled adjustments' window to open, add adjustment procedures. Remember, only Administrator can add new entries.

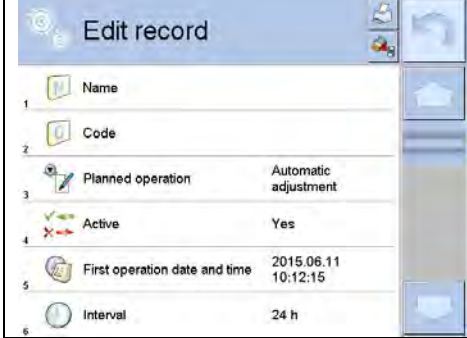

In order to add a new position, press  button, wait for a window with data on scheduled adjustment to open.

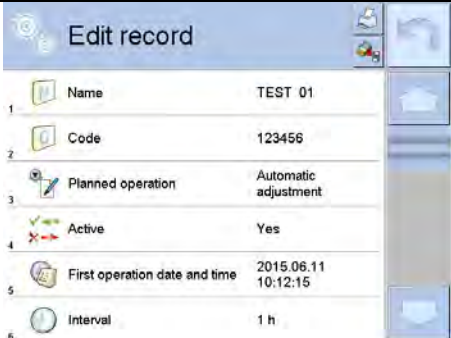
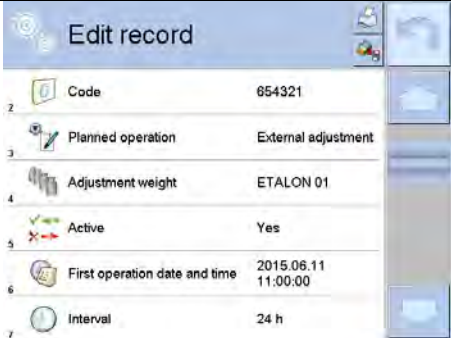
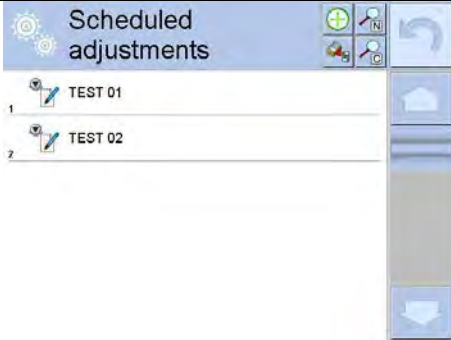

Select task: automatic adjustment (internal or external).

| | |
|--|--|
|  | <p>For automatic adjustment option, enter data on the adjustment and its schedule.</p> |
|  | <p>For external adjustment option, enter data on the adjustment, mass standard used for the adjustment performance and its schedule.</p> |
|  | <p>When all necessary data has been introduced, return to the previous window. The window features newly added entry.</p> |

Upon entering all data, exit the menu.

Now all the adjustments are carried out automatically as scheduled and with specified time intervals.

11.8. Report Printout

 Report printout parameter determines whether or not an adjustment report is to be automatically printed upon adjustment process completion.

In order to set automatic report printout, go to  Report printout parameter and select <YES> value.

11.9. GLP Project

GLP is one of many methods for documenting work in accordance with adopted quality system. Data selected for printing is printed on each release of an adjustment report.

Information and signs to be used in a GLP report:

- adjustment (adjustment type)
- working mode (working mode name)
- date, time
- operator
- balance type
- balance S/N
- level status

- nominal mass
- current mass
- difference
- temperature
- empty line
- dashes
- signature
- non-standard printout

11.10. Adjustment History

Adjustment history contains data on all carried out adjustment processes. The record is carried out automatically. Each record on adjustment comprises basic data on completed process. This menu enables displaying the list of completed adjustment processes. Each report is printable.

In order to print an adjustment report, enter <Adjustment> submenu, next enter <Adjustment history>, select adjustment to be printed. Upon displaying record details, press < > print key located on the top of the display.

CAUTION:

If the balance memory is full, the oldest record gets automatically deleted.

If internal procedures of an organization require maintaining complete documentation concerning all carried out adjustment processes, then the list with adjustment records has to be printed and archived periodically.

Searching for Adjustment Record

The module enables searching for a specific completed adjustment record. To do that, press  search button and enter date of an adjustment process that is to be found.

Exporting data on completed adjustment process

Connect a USB flash drive to balance's USB port. Press <Data export> button located on the top of the display. The process is fully automatic and on its completion a file with **.db.** extension is saved on a USB flash drive connected to the USB port.

12. OPERATORS

Operators database features list of users permissioned to operate the weighing device. The following data can be defined for each balance operator:

- Name
- Code
- Password
- Name and surname
- Permissions
- Account active
- Language
- Default profile
- Card no.

New operator can be added by the Administrator exclusively.

Procedure:

- Enter <Operators> menu, press <Add>  button.
- Define all necessary data.

CAUTION:

It is possible to search for an operator in a database of operators by code or name.

Editing data on an operator:

- Press field with operator name.
- Data on a specific operator is displayed.
- Select and change necessary data.

New operator can be deleted by the Administrator exclusively.

Procedure:

- Press and hold operator name.
- Database menu is displayed.
- Select <Delete> parameter.



13. ADMINISTRATOR PANEL

 Administrator panel enables to determine activities of an operator with determined permissions, password strength and permissions for an unlogged operator.

CAUTION: Only operator with <Administrator> permissions can modify this menu.

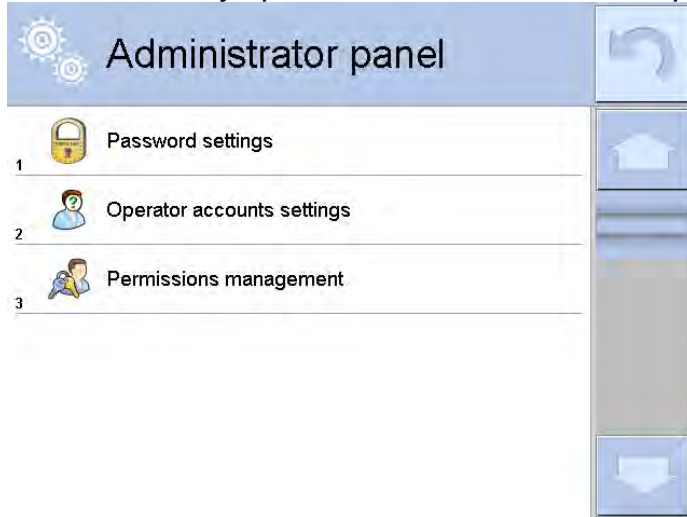

13.1. Password Settings

Menu enables to determine password strength.

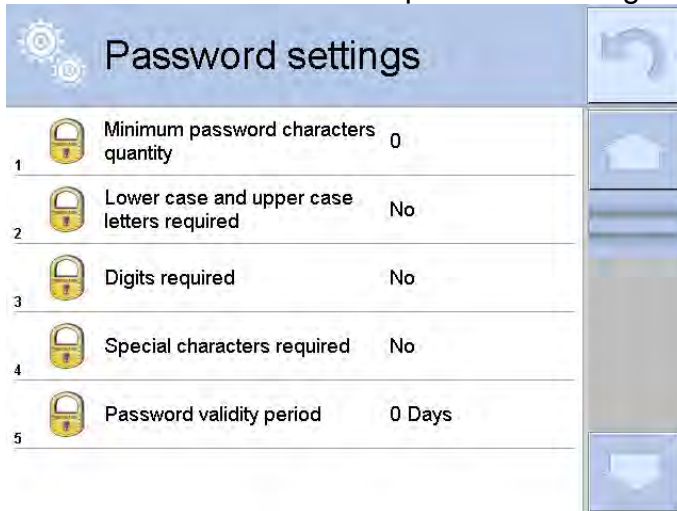

| | |
|--|---|
| Minimum password characters quantity | Determining minimum quantity of characters in operator's password. For „0” value selected, an operator can set any quantity of characters. |
| Lower case and upper case letters required | Determining requirements for characters in operator's password. |
| Digits required | |
| Special characters required | |
| Period of password validity | Determining the period after which the password has to be changed. For „0” value selected password change is not required. |

13.2. Operator Accounts Settings



Permissions of an unlogged operator

Administrator can assign an unlogged weighing device operator (so called anonymous operator) with permissions level.

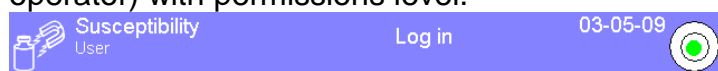

Procedure:

- Enter <  Permissions > menu.
- Select < Anonymous operator > parameter.
- Set appropriate permissions for the anonymous user.
- Set one of four options: Guest, Operator, Advanced operator, Administrator.



CAUTION:

Operator assigned with <Guest> permissions is not allowed to modify program settings.

Automatic log out

With Auto logout function on, the operator is logged out automatically if the balance is not operated within a specified time interval, given in minutes.
By default the function is disabled (<None> value set).

Procedure:

- Enter <  Permissions > menu.
- Select <  Printouts > parameter.
- Set one of four options: none/3/5/15/30/60. Time given in [min].

13.3. Permissions Management

| Permissions management | | |
|------------------------|----------------------|---------------|
| 1 | Database | |
| 2 | Date and time | Operator |
| 3 | Printouts | Administrator |
| 4 | Header printout | Operator |
| 5 | Footer printout | Operator |
| 6 | Printout / Enter key | Operator |

Databases

| Permissions management | | | Database | | |
|------------------------|----------------------|---------------|----------|-------------------|---------------|
| 1 | Database | | 1 | Databases preview | Operator |
| 2 | Date and time | Operator | 2 | Products | Administrator |
| 3 | Printouts | Administrator | 3 | Customers | Administrator |
| 4 | Header printout | Operator | 4 | Formulations | Administrator |
| 5 | Footer printout | Operator | 5 | Packaging | Administrator |
| 6 | Printout / Enter key | Operator | 6 | Warehouses | Administrator |

Default balance settings enable operator who is logged as **Administrator** to modify databases. The software allows to change permissions.

Procedure:

- Enter < Administrator panel> submenu, select <Databases> option, next set respective permissions.
- Set one of four options: Guest, Operator, Advanced operator, Administrator.

CAUTION:

When <**Guest**> option is set, settings submenu is freely accessed (there is no need to log in).

Date and time

Default balance settings enable operator who is logged as **Administrator** to modify date and time parameter. The software allows to change permissions, and as a result authorize other operators to access < Date and time> parameter.

Procedure:

- Enter < Permissions> menu.
- Select < Date and time> parameter.
- Set one of four options: Guest, Operator, Advanced operator, Administrator.



CAUTION:

When <**Guest**> option is set, all unlogged operators can edit date and time.

Printouts

Default balance settings enable operator who is logged as **Administrator** to edit printouts but the software allows to change permissions, and as a result authorize other operators to access < Printouts> parameter.

Procedure:

- Enter < Permissions> menu.
- Select < Printouts> parameter.
- Set one of four options: Guest, Operator, Advanced operator, Administrator.



CAUTION:

When <Guest> option is set, all unlogged operators can edit printouts.

Value release

Default balance settings enable operator who is logged as **User** to carry out printouts. The software allows to change permissions, and as a result authorize other operators to access < Value release> parameter.

Procedure:

- Enter < Permissions> menu.
- Select < Value release> parameter.
- Set one of four options: Guest, Operator, Advanced operator, Administrator.



CAUTION:

When <Guest> option is set, <Value release> submenu is freely accessed (there is no need to log in).

Videos

Default balance settings enable operator who is logged as **Administrator** to modify <Videos> submenu (add or delete files). Providing that respective modifications have been introduced by the Administrator, it is possible for remaining operators to access < Videos> menu options too.

Procedure:

- Enter < Permissions> menu.
- Select < Videos> parameter.
- Set one of four options: Guest, Operator, Advanced operator, Administrator.

CAUTION:

When <Guest> option is set, <Videos> submenu is freely accessed (there is no need to log in).

14. PROFILES

A Profile is a data pack that determines:

- function operation, e.g. parts counting, percent weighing, etc.
- data to be displayed during operation,
- function keys to be active,
- measuring units to be accessible
- criteria determining speed of operation and measurement stability,

Balance software allows you to create numerous profiles, this enables:

- designing an individual working environment by each operator,
- customized balance operation, i.e. activating selected function keys and information (improved operation performance).

To simplify weighing instrument operation, there are 4 profiles in the software. The profiles are selected and saved so that the weighings for respective requirements and conditions are optimized.

Profile types:

- **Fast** – profile set to enable fast measurement of mass of any size regardless of the selected working mode. Fast profile gets activated automatically at the first balance start-up. For Fast profile, the parameters settings enable obtaining the final result as fast as possible.
- **Fast dosing** – profile intended for dosing, it is set to enable fast dispensing of product. For this profile selected, the DOSING mode gets activated automatically,
- **Precision** – profile set to enable precise measurement of mass of any size regardless of the selected working mode. For Precision profile the weighing process takes a lot of time, but this guarantees the most precise weighing result.
- **User** – basic profile, filters settings provide quite fast and precise measurement. For this profile selected, the WEIGHING mode gets activated automatically.

CAUTION: as an operator you can modify all profile settings only for User profile, when it comes to the remaining default profiles (Fast, Fast dosing and Precision) they can only be modified partially. Each additional profile you created can be modified in terms of all settings.

14.1. Creating a Profile

Default profile: <Home>. The Administrator can create new profiles by:

- Copying an already existing profile and modifying it,
- Creating a new profile.

Copying an existing profile



Procedure:

- Enter the main menu, to do it press **Setup** key.
- Enter <Profiles> submenu.
- Press and hold profile that is to be copied.
- Menu referring to a profile record is displayed.
- Select <Copy> parameter.

- A new <Copy name> profile is created, new profile settings and base profile settings are identical.
- Modify necessary data: (name, etc.).

Adding a new profile

Procedure:

- Enter the main menu, to do it press **Setup** key.
- Enter <Profiles> submenu.
- Press  button, message box: <Create new record?> is displayed.
- Press  button to confirm. The software automatically adds a new record and enters its editing mode.

Deleting a profile

Procedure:

- Enter the main menu, to do it press **Setup** key.
- Enter <Profiles> submenu.
- Press and hold profile that is to be deleted.
- Menu referring to a profile record is displayed. Select <Delete> parameter.
- Message box: <Delete?> is displayed.
- Press  button to confirm, the profile gets deleted.

CAUTION:

In order to operate profiles it is necessary to log in as an Administrator.

14.2. Profile Structure

Profile parameters list:

| | |
|----------------------|--|
| Settings | Enter this menu to set an individual profile name (an order of alphanumeric characters), and to declare a default working mode (the selected mode is activated as default upon selecting the profile). |
| Working Modes | Contains the following submenus: <ul style="list-style-type: none"> ▪ Additional settings of a working mode ▪ Control ▪ Information ▪ Printouts |
| Readout | Contains the following submenus: <ul style="list-style-type: none"> ▪ Filter ▪ Value release ▪ Autozero ▪ Autozero: Dosing ▪ Last digit |
| Units | Enter this menu to declare the start unit, the supplementary unit, 2 custom units and to enter the value of gravitational acceleration force in module's operation place. |

14.2.1. Settings

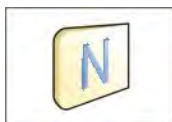

Name

Upon entering this parameter, a message box with an on-screen keyboard is displayed. Enter the name of a profile and press  button to confirm. The name is assigned to the profile.



Default working mode

Upon entering this parameter you can select a specific working mode that is to be set as default. For <None> parameter set, upon selecting the profile, the balance activates the most recently used working mode.

14.2.2. Working Modes

Upon entering Working Modes parameter, a window containing all accessible working modes is displayed. Parameters are set for each working mode independently. Particular profile when activated runs with given set of parameters.

You can enter the following data for each working mode:

- Settings:
contains specific parameters relating to a working mode and universal settings, such as: result control, tare mode, automatic footer printout, printout mode, printout.
- Quick access buttons:
declaring quick access buttons to be displayed.
- Information:
declaring information to be displayed.
- Printouts:
declaring type of a printout or defining a non-standard printout.

14.2.3. Readout

The function enables you to adjust balance operation to ambient conditions (filter settings) or your individual needs. <Readout> menu contains the following elements:

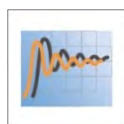

FILTER (function unavailable for the following profiles: Fast, Fast dosing, Precision)

Each measurement signal before being displayed is electronically processed in order to provide correct parameters specific for stable measurement result, i.e. ready to read.

You can determine signal processing rate, there are five different filters for you to select from. Range:

- very fast, fast, average, slow, very slow.

While setting the filter consider the actual operating conditions. In case of very good operating conditions select average or fast filter in case of rough conditions select slow or very slow filter.

CAUTION:

- *for precision balances set: very fast ÷ or average filter,*
- *for analytical balances and microbalances set: ÷ very slow filter.*



Value release (option disabled for the following profiles: Fast, Fast dosing, Precision)

The parameter has been designed to determine when the stability marker is to be displayed.

There are three different settings for value release parameter:

- fast, fast and reliable, reliable.



CAUTION:

Both parameters, filter and value release, determine how long it takes to obtain stable result.



Autozero Function

The function has been designed to enable automatic control and correction of zero indication.

If the function is enabled, the subsequent measurement results are compared to each other in constant time intervals. If the results differ less than declared AUTOZERO range, e.g. 1 division, the balance is automatically zeroed, and the pictograms of stable indication –  and precise zero –  are displayed. Active Autozero function means, that each measurement starts with the precise zero. There are, however, some cases when this function can be a disturbing factor for the measuring process, e.g. very slow placing of a load on the weighing pan (load adding, e.g. pouring, filling). In such case, the system correcting zero indication may also correct the actual indication of a load placed on the weighing pan.

Accessible settings: **NO** - autozero function disabled
YES - autozero function enabled



Autozero function: Dosing (function unavailable for the following profiles: Fast, Fast dosing, Precision)

The function has been designed to set autozero to default value selected for dosing.

Options:

- NO** - autozero operation is automatically disabled on entering dosing mode.
- YES** - autozero operation is automatically enabled on entering dosing mode.



Last Digit

The function has been designed to enable/disable visibility of the last decimal place of measurement result. Accessible settings:

- **Always:** all digits are displayed.
- **Never:** last digit disabled.
- **When stable:** last digit displayed only when the result is stable.

Ambient Conditions

Parameter relating to ambient and environmental conditions of the workstation. For unstable ambient conditions it is advisable to set the parameter to value: Unstable. By default the parameter is set to value: Stable.



Setting 'Stable' value results with faster operation, i.e. weighing takes much less time than in case of setting the parameter to value: Unstable.

- **Unstable, Stable.**

14.2.4. Units

For a selected profile you can declare start unit, supplementary unit and two custom units. You can also determine which units are to be displayed during operation.

A custom unit features:

- a multiplier
- a name (3 characters)

Upon completed operation of designing a custom unit its name is added to the list of accessible measuring units.

Units menu enables you to enter the value of gravitational acceleration force characteristic for a place of use. It is obligatory should a balance be used to determine mass in [N].

15. WORKING MODES - GENERAL INFORMATION



Weighing

Means of operation: weight of a load is determined through an indirect measurement. The balance measures gravitational force which attracts the load. The obtained result is processed and displayed on the balance screen in a digital format.



MAGNETISM

RADWAG-manufactured susceptometer enables carrying out measurement of magnetic susceptibility and magnetization of weights of class E1 and lower in accordance with OIML R111.

SM susceptometer is a complete reference solution for specifying the magnetic characteristics even for weights of E1 class. The instrument features user-friendly menu. Modular design, upon disassembling respective module, enables using the susceptometer as a mass comparator or a balance.

SM-UYA-6.4Y features internal adjustment option and readability of [d] 01 µg for loads within the range of 2 g to 50 kg.

Settings menu contains special functions for adapting balance operation to customer needs. They are activated upon selecting a respective profile. For detailed description of specific working mode settings refer to the given working mode section.

15.1. Working Modes

To run working mode other than currently operated one:

- Press active working mode name.

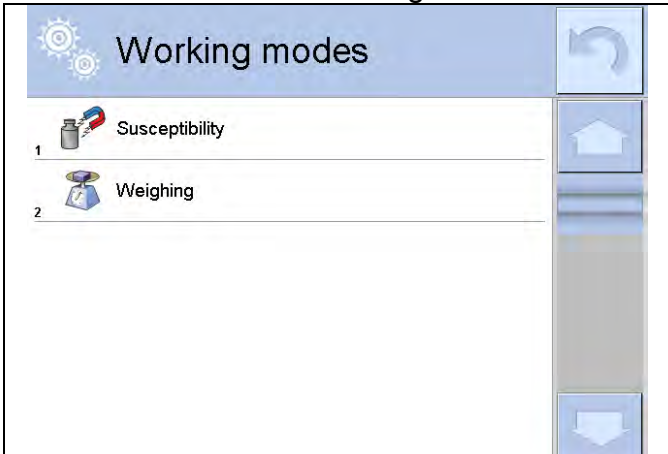
| | |
|---|---|
|  | <ul style="list-style-type: none">•List of working modes is displayed.•Select the mode that is to be operated. |
|---|---|

15.2. Working Mode Parameters

Each working mode has programmable parameters determining its functioning. To access particular working mode parameters:

1. Press grey workspace area.
2. The following menu is displayed:
 - <Settings> - additional options.
 - <Keys> - defining quick access buttons .
 - <Information> - selecting information to be displayed in the workspace.
 - <Printouts> - selecting printout type and content.
 - <Profile> - selecting a profile to be active in the course of operation .

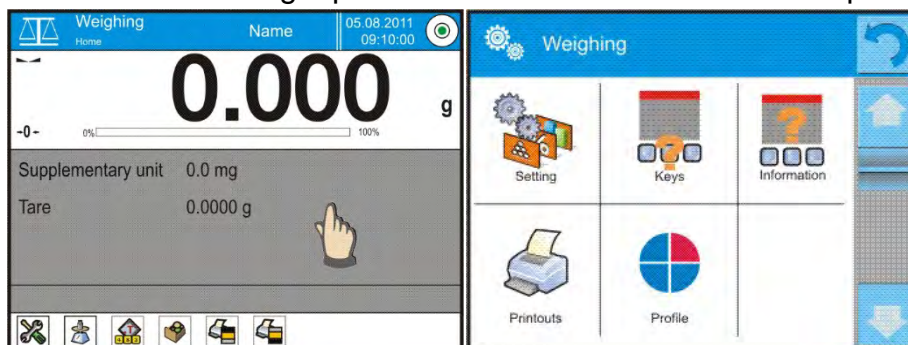

3. Enter particular submenu and select the component that is to be modified

For detailed information on parameters of <Settings> menu go to section 16.7 Additional Parameters for a Weighing Process. For detailed overview of particular mode's parameters read section providing information on the mode in question.

15.3. Quick Access Buttons, Proximity Sensors

You can define up to 7 quick access buttons, which are to be displayed in the bottom bar. Upon assigning a function to a button a corresponding pictogram is displayed in the bottom navigation bar of the home screen. Each working mode features customized set of buttons. For complete buttons list read Appendix B.

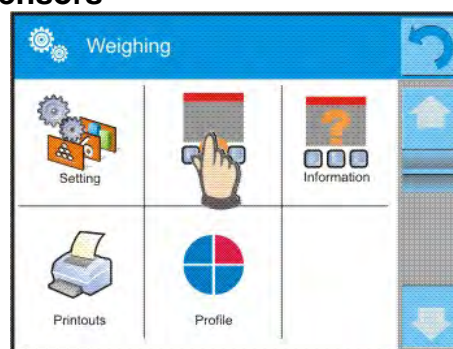

These are so called quick access keys for triggering the most often performed operations.

Caution: You can view user manual saved to balance memory. In order to take advantage

of this function add  help button to a tool bar.

15.3.1. Proximity Sensors

The balance features two proximity sensors enabling touch-free control.

The program detects four motions performed around the sensors:

1. Hand in a close vicinity to the left sensor <Left sensor>.
2. Hand in a close vicinity to the right sensor <Right sensor>.
3. Hand motion to the left over both sensors (move your hand over right sensor first, left next) <Proximity sensor: gesture to the left>.

4. Hand motion to the right over both sensors (move your hand over left sensor first, right next) <Proximity sensor: gesture to the right>.

Caution:

Using GESTURE TO THE LEFT or GESTURE TO THE RIGHT, it is necessary to remember that <Proximity sensors delay> parameter must be set to value **500 ms!**

List of operations to be assigned: None; Profile; Adjustment; Zeroing; Taring; Tare setting; Disable tare; Enable tare; Packaging; Print; Header printout; Footer printout; Unit; Universal variable 1; Universal variable 2; Universal variable 3; Universal variable 4; Universal variable 5; Accept; Abort; Operator; Left door; Right door; Open/close door; Parameters; Product; Warehouse; Customer.

Upon completed configuration procedure, the software runs function assigned to a particular proximity sensor, having detected motion around it. To provide correct operation, it is necessary to set respective proximity sensors sensitivity and delay (read section 22 'Proximity sensors sensitivity').

15.4. Information

Information on weighing process is displayed in the grey workspace. The workspace can contain up to 6 data. If larger amount of data is selected, then only the first 6 are displayed.

Each parameter features two options:

- YES, information enabled (displayed in the workspace).
- NO, information disabled.

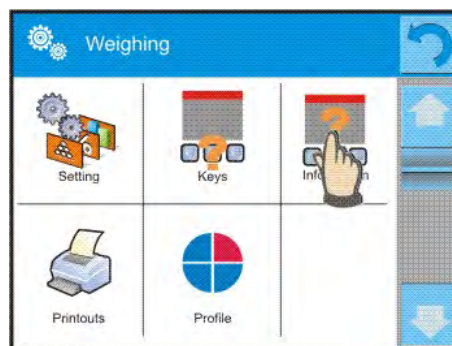

15.5. Printouts

Printouts menu comprises two separate sections:

- standard printouts, non-standard printouts.

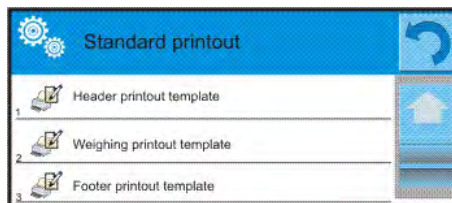

Standard printout

Standard printout comprises three internal sections containing different variables. YES value - variable printout enabled, NO value - variable printout disabled.

Procedure:



1. Press field with name of a template to be edited (Header – Weighing – Footer) and select variables to be printed.
2. If a printout is a non-standard one, create it.

| HEADER | WEIGHING | FOOTER |
|--|---|---|
| <ul style="list-style-type: none"> - Dashes - Working mode - Date - Time - Balance type - Balance S/N - Operator - Level status - Customer - Warehouse | <ul style="list-style-type: none"> - N (measurements quantity) - Date - Time - Level status - Customer - Warehouse - Product - Packaging - Universal variable 1 ... 5 - Net - Tare | <ul style="list-style-type: none"> - Working mode - Date - Time - Balance type - Balance S/N - Operator - Level status - Customer - Warehouse - Product |

| | | |
|---|---|---|
| <ul style="list-style-type: none"> – Product – Packaging – Universal variable 1 ... 5 – Empty line – GLP report – Non-standard printout | <ul style="list-style-type: none"> – Gross – Current result – Additional unit – Mass – Non-standard printout | <ul style="list-style-type: none"> – Packaging – Universal variable 1 ... 5 – Dashes – Empty line – GLP report – Signature – Non-standard printout |
|---|---|---|

HOW TO OPERATE PRINTOUTS

1. In order to print WEIGHING section variables press PRINT button on balance's panel, only variables with attribute YES can be printed (see the above list).
2. Variables with YES attribute present in the HEADER and FOOTER are printed **ONLY** upon pressing **PRINT HEADER** and **PRINT FOOTER** pictograms. The pictograms have to be added to the bottom bar of the display, as quick access buttons.
(For detailed instruction on how to add quick access buttons to the bottom bar of the display go to section 15.3)

| | |
|---|---|
|  |  |
| Print header data | Print footer data |

CAUTION:

Measuring units for mass indication:

- Net – the main measuring unit (adjustment unit)
- Tare – the main measuring unit (adjustment unit)
- Gross – the main measuring unit (adjustment unit)
- Current result – currently displayed measuring unit
- Supplementary unit – supplementary measuring unit
- Mass – the main measuring unit (adjustment unit)

Non-standard printout

Non-standard printout may contain: TEXTS and VARIABLES (acquired from the software during printout). Each non-standard printout is a separate project, featuring specific name, by which it is identified, and saved to the database of printouts.

Procedure:

1. Press <Non-standard printout> field.
2. Press  Add> button, window featuring Name/Code/Project data opens.
3. Set name and code of a printout.
4. Press <Project> button,
5. Printout edit box with an on-screen keyboard is displayed.
6. Use the keyboard to design printout template, the printout may contain texts and variables

CAUTION:

- It is possible to add a printout by importing configured texts from flash drive connected to balance's USB port.
- Printout's name is **ONLY** a NAME, and it is not part of its content.
- For information on how to design a non-standard printout template read section 18.7 Printouts.

15.6. PROFILES

Profiles function has been described in section 14 Profiles.

16. WEIGHING

Load the weighing pan. Wait for a stable indication (display of stability marker, \blacktriangle) and read the measurement result.

Record/printout of the measurement result is available on pressing <PRINT> key:

- for non-verified balances – stable and unstable measurement results are saved or printed (regardless of stability marker \blacktriangle absence). For unstable measurement result question mark <?> is printed next to the mass value.

16.1. Weighing Unit Selection

Change of weighing unit is carried out by pressing the weighing unit pictogram visible next to the value of measurement result. Upon pressing the weighing unit, list of available units is displayed. Select the unit you need, the software automatically recalculates indicated value.

Units list:

| <i>unit</i> | <i>denotation</i> | <i>unit</i> | <i>denotation</i> |
|-------------|-------------------|-----------------|-------------------|
| gram | [g] | Taele Hongkong | [tlh] |
| milligram | [mg] | Taele Singapore | [tls] |
| carat | [ct] | Taele Taiwan | [tlt] |
| pound | [lb] | Taele China | [tlc] |
| ounce | [oz] | Momme | [mom] |
| ounce Troy | [ozt] | Grain | [gr] |
| pennyweight | [dwt] | Newton | [N] |
| | | Tical | [ti] |

16.2. Good Weighing Practice

To assure long-term operation and correct mass measurements, follow the rules presented below:

- Start the balance with no load on the weighing pan (permissible value of load on the weighing pan at start is $\pm 10\%$ of the maximum capacity).

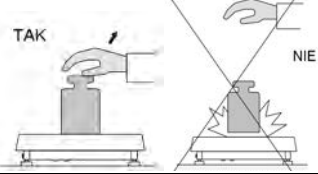
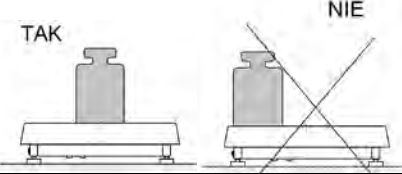
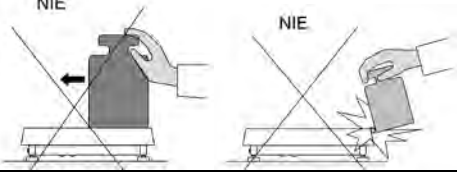
| | |
|---|--|
|  |  |
| <p>Load the weighing pan steadily avoiding shocks. Setup/Misc./Vibrations detection parameter enables control of weighing pan loading (section 22.8).</p> | <p>Place weighed loads centrally on the weighing pan</p> |
|  | |
| <p>Avoid side loading, in particular side shocks</p> | |

16.3. Level Status

The balance is equipped with an AutoLEVEL System which enables monitoring of the balance level. Level monitoring is performed uninterruptedly in the course of balance operation. Level status is signalled with a respective pictogram, displayed in the upper right corner of the work panel. The system monitors balance level state and on detecting any change the position of level marker is displayed on the screen and/or respective alarm is activated. Balance level setting proceeds.

Levelling procedure:

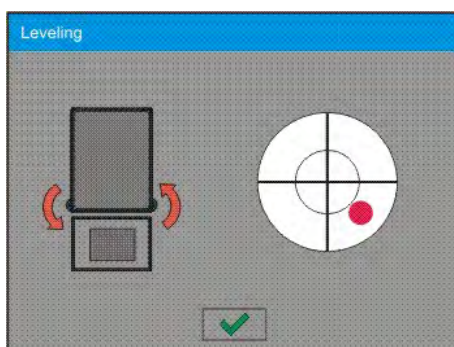

- Press level status  pictogram located on the top of the display.
- Control panel of level function is displayed. Along with the level indicator, balance view is presented.



- Level the balance by turning its feet left/right, follow the blinking pictograms,  – press to make level marker move toward the centre of the circle.
- When the marker takes central position, its colour turns from red to green – the balance is correctly levelled.

Caution: The balance is equipped with Automatic Level Control mechanism. For detailed information regarding the mechanism operation refer to section 22.9 of this user manual.



16.4. Zeroing

To zero mass indication press  key. Zero indication and the following pictograms are displayed:  and . Zeroing operation means determining new zero point, recognized by the weighing instrument as precise zero. The instrument can be zeroed only when the indication is stable.

CAUTION:

Indication can be zeroed only within $\pm 2\%$ range of maximum capacity. If the zeroed value is above $\pm 2\%$ of the maximum capacity, then the software indicates a respective **Err2** error message.



16.5. Taring

To determine net weight value, load the weighing pan with a packaging, wait for a stable indication and press  key. Zero indication and the following pictograms are displayed: **Net** and . Upon unloading the weighing pan, the sum of tared masses with minus sign is displayed. You can assign tare value to a particular product stored in the database. In such case the assigned tare value is automatically acquired upon selection of the given product.

CAUTION:

It is impossible to tare negative values. When you try to tare negative values, the weighing instrument responds with an error message: **Err3**. In such case, zero the indication and repeat taring procedure.

Entering tare value manually**Procedure:**

- Press quick access button. The button is available regardless of the working mode you operate  operate .
- An on-screen numeric keyboard is displayed.
- Enter tare value and press  button.
- Balance returns to weighing mode. Tare value with „-“ sign is displayed.

Deleting tare

The tare value indicated on the display can be deleted by pressing key on the operation panel, or by using programmable <Deactivate tare> function button.



Procedure 1 - upon taking the tared load off the weighing pan:

- press ZERO key,
- the <Net> marker gets deleted, new zero point is determined.

Procedure 2 - with tared load on the weighing pan:

- press ZERO key,
- the <Net> marker gets deleted, new zero point is determined.
- when the tare value exceeds 2% of the maximum capacity, -Err- message is displayed in order to inform you about the fact that operation cannot be carried out.

Procedure 3 - when the tared load is on the weighing pan or upon taking the tared load off the weighing pan:

- press  <Deactivate tare> programmable button,
- the NET marker is deleted.
- the display indicates tare value.
- to restore the last tare value press  <Restore tare> button.

16.6. Use of Air Buoyancy Compensation Factor

The application enables correcting mass measurement errors in the course of:

1. weighing loads of density considerably different from the density of standard that has been used to adjust the balance; typically the balance is adjusted with a steel mass standard with density $\sim 8.0\text{g/cm}^3$ or a brass mass standard with density $\sim 8.7\text{g/cm}^3$; if loads made of other substances are weighed, then ratio indicated on the graph below applies.

Error value in relation to density of weighed sample

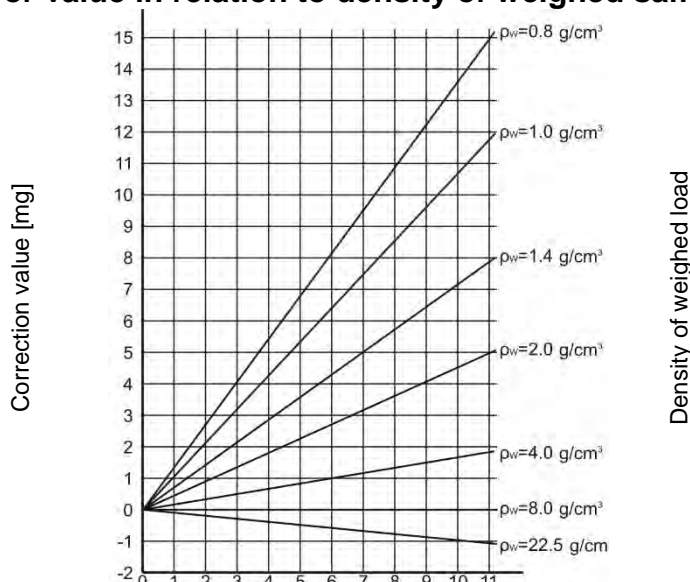

The graph presents correction values for versus the density of weighed load, assumption that air density is constant and equals 1.2 kg/m^3 is taken.

- testing sample mass change within a few hours long period of time for a case when the sample mass is relatively constant (minor changes). It is assumed that air density changes affect considerably the final result, wherein the density is influenced by changes of pressure, temperature and humidity.

In order to carry out a reliable measurement it is necessary to know the measuring methods, features of tested sample, ambient conditions, air density in the laboratory room and density of weighed sample.

FUNCTIONING

The air buoyancy compensation procedure is to be used as follows:

- Method 1:
 - Enter air density value and value of weighed sample density to balance's memory.
 - Wait, the software automatically calculates the correction factor for weighed mass, next corrected value of weighed mass is displayed.
 - In order to avoid mistakes, the corrected mass value is accompanied by <!> symbol, the symbol is visible on a display and a printout.
- Method 2:
 - Determine air density value with use of module program (semi-automatic operation) and enter value of weighed sample density to balance's memory.
 - Determination of air density is carried out using a set of two mass standards, one made of stainless steel, and the other one of aluminium. Based on mass indications of the two standards, the software automatically calculates the air density and saves the value in balance's memory on operator's confirmation. Now, enter value of weighed sample density to balance's memory.
 - Wait, the software automatically calculates the correction factor for weighed mass, next corrected value of weighed mass is displayed.
 - The corrected mass value is accompanied by <!> symbol, the symbol is visible on a display and a printout.

In order to enable/disable the air buoyancy compensation procedure go to the user menu. The procedure is valid for weighing mode exclusively.

AIR BUOYANCY COMPENSATION START-UP

Procedure:

- 1. Enter home screen and press grey workspace.

- 2. Select <Settings> parameter.



- Select <Air buoyancy compensation> parameter.

Parameter values:

- Air buoyancy compensation – YES/NO.
- Sample density (enter value of weighed sample density). If you use products from databases, then on product selection its density value is automatically uploaded.
- Air density – parameter designed to enable you to select the method of entering the air density value.

Parameter values:

VALUE – select to open a window where you enter specified air density value (e.g.: determined by means of other methods). The entered value is used in the course of compensation. It is assigned automatically upon completed air density determination (to

complete air density determination press <> button).

ONLINE – select to make the balance acquire air density value from a connected THB sensor at a real time, if such is connected to the balance, or from internal sensor installed in the balance.

If your balance features both types of sensors (THB and internal), then data from the THB supersedes the other, in such case go to **Setup/Ambient conditions/Ambient conditions module** and set **SAVE or SAVE & ALERTS** parameter.

If your balance features only one set of sensors recording temperature, humidity and pressure, then correct ONLINE operation requires setting the following parameters:

- internal sensors exclusively – go to **Setup/Ambient Conditions/Ambient Conditions Module** and set NONE value,
- external THB sensor exclusively – go to **Setup/Ambient Conditions/Ambient Conditions Module** and set SAVE or SAVE & ALERTS value.

For correct balance cooperation with the THB sensor it is necessary to set port's transmission parameters, they must be compatible with those of the THB sensor. The THB sensor transmission parameters are detailed on its data plate.

On returning to the weighing mode, the display indicates an additional symbol <!>, as indicated on the figure below. From now on the value of indicated mass is corrected including the air buoyancy compensation factor and sample density.



The measurement result can only be compensated by a correct value if the operator enters the actual value of the air density and correct value of weighed sample density to balance's memory.

CAUTION:

*If the <AIR BUOYANCY COMPENSATION> parameter is set to <ONLINE> parameter, then pictogram <!> is not displayed. This means that parameter **Setup/Ambient Conditions/Ambient Conditions Module** is set to SAVE or SAVE & ALERTS value, and that there is no physical connection between a balance and the module, or that balance-module communication parameters are incorrect. In such case plug a THB module to balance's ports COM 1 or COM 2 and set appropriate communication parameters, for the parameters refer to a data plate.*

16.7. Additional Parameters for a Weighing Process

Modification of weighing functions enables programming balance operation.

Procedure:

- Press grey workspace area.
 - The following submenus are displayed: Settings, Buttons, Information, Printouts, Profile.
 - Enter particular submenu and select the component that is to be modified
- <Settings> - additional options related to weighing mode,
<Keys> - defining quick access buttons,
<Information> - supplementary data on weighing process displayed in an Info field,
<Printouts> - selecting printout type,
<Profile> - selecting profile that is to be active during balance operation,
<SETTINGS> - weighing process related data such as:
- **Tare mode**
Available options:
 - **SINGLE:**
mass value saved to balance memory on single pressing of TARE key. Subsequent pressing of TARE key determines new tare value. Selecting product or packaging to which tare value is assigned causes automatic deleting of previously assigned tare value.
 - **CURRENT SUM**
total value of currently entered product and packaging tare values (result of selection of product and packaging from the database) with possibility to add tare value entered manually. When new tare value for a product or packaging is set again then tare value entered manually gets deactivated.
 - **TOTAL SUM**
total value of all entered tare values.
 - **AUTOTARE:**
Means of operation:
Each first stable measurement result is tared. NET sign is displayed. Now you can determine net mass of weighed load. Upon unloading the weighing pan and autozeroing, tare value is automatically deleted
 - **Automatic footer printout**
Available options:
MODE – None – manual footer printout,
Sum of measurements – footer is printed when mass value entered in <Threshold> parameter gets exceeded.
Measurements quantity – footer is printed when a pre-defined measurements quantity (a batch) set in parameter <Threshold> is carried out.
THRESHOLD – setting the threshold value determining footer printout.
For <Sum of measurements> parameter, threshold value is determined in measuring unit [g], for <Measurements quantity> parameter the unit is not determined, the provided value specifies carried out measurements quantity.
 - **Printout/Enter mode**
 - **PRINT/RELEASE BUTTON** (manual operation)

- Never – printout disabled.
- First stable – first stable measurement is recorded.
- Each stable – all stable measurements are registered.
- Each – printout of all measurements (stable and unstable), for verified balance only stable measurements are printed out (as in <Each stable> setting).

- **AUTOMATIC MODE**

- Never – printout disabled.

First stable - first stable measurement is recorded upon loading of the weighing pan with a load; record of the next stable measurement result takes place only if the following conditions are met: weighing pan gets unloaded, measurement value lower than value of set threshold is displayed, a new load is placed on the weighing pan.

Last stable - last stable measurement, registered prior unloading, is recorded. The record takes place only if the following conditions are met: weighing pan gets unloaded, measurement value lower than value of set threshold is displayed

- With interval – select this value to start automatic printout and record of indications in WEIGHINGS database, carried out in a cyclic manner in a specified time intervals. The interval is set in [min] in <INTERVAL> parameter. Interval range is 1 - 9999 min.

CAUTION:

Each weighing result is printed and recorded (stable and unstable for a non-verified balance, stable for a verified balance).

Automatic operation with interval starts at the moment of switching the function on. The first stable weighing result of value greater than THRESHOLD value is printed and recorded as the first measurement. The following measurements are printed with frequency set in INTERVAL parameter. To stop the automatic operation with interval, switch the option off.

- **THRESHOLD:**
Mass value obligatory for operation of automatic printout, set in grams.
- **INTERVAL**
Record frequency for automatic operation with interval

– **Printout**

Printout type related to a working mode. Printout is activated by pressing PRINT key on balance panel.

Available options:

- **STANDARD PRINTOUT:**
Enables declaring content of the following printouts: HEADER, WEIGHINGS and FOOTER.
Select <YES> parameter for the components that are to be printed on pressing printout activating function key.
- **NON-STANDARD PRINTOUT:**
Enables selecting one of database-stored non-standard printouts from a list of <PRINTOUTS> menu, or designing a unique printout which is automatically added to the database.

Caution: For detailed instruction refer to section 18.7 of this user manual.

– **Air buoyancy compensation**

Parameters allowing you to switch on the compensation and to enter weighed sample density data and air density data.

Caution: *Function valid for weighing mode exclusively.* For detailed information regarding the operation and settings refer to the previous section of this user manual.

16.8. Minimum Sample Weight

Weighing mode settings comprise <Minimum sample weight> function. In order to use the function it is necessary to enter data related to minimum sample weight determination methods and minimum sample weight values for a given method. The data must be entered to <Minimum sample weight> database. The database is empty in standard balance version.

Determining minimum sample weight and adding data to the : <Minimum sample weights> database can be carried out by an authorized “RADWAG” personnel exclusively.

Should you use the minimum sample weight function, and need data on minimal sample weight to be entered to balance menu, please contact the local representative of “RADWAG” company.

Using reference weights, the authorized RADWAG employee determines minimum sample weight for specified tare containers. This operation is carried out at the place of use and in accordance with requirements of the applied quality system. The obtained values are entered to balance software: <Minimum sample weights> database.

For a particular method of minimum sample weight determination, it is possible to define few tare values along with values of minimum sample weights, expiry dates of the carried out measurements and entered data. The settings are not to be edited by a balance user.

<Minimum sample weight> function guarantees that the results of weighing operation are comprised within the set tolerance, in accordance with applied quality management system of particular company.

CAUTION: *Function valid for weighing mode exclusively.*

Available options:

- **METHOD**

Option allowing you to select used quality standard. Press METHOD field to open a window with a list of database-stored methods by means of which the minimum sample weights were determined. In order to add a new method enter <Databases /Minimum sample weights>.

- **MODE**

Block – select to display pictograms informing you on status of weighed mass (weighed mass below/above minimum sample weight) and to disable accepting the measurement result if it is below the minimum sample weight limit.

Warn – select to enable display of respective pictograms informing you about the measured mass (whether it is lower than the MSW value or higher than the MSW value). You can accept the measurement that is lower than the MSW value. Mind that on a printout it will be preceded by an asterisk (*).

CAUTION:

For information on how to enter a method for minimum sample weight go to section 18.5 <Databases /Minimum sample weights> of this user manual. New minimum sample weight values can be entered by an authorized RADWAG personnel exclusively.

Weighing with use of <MINIMUM SAMPLE WEIGHT> function

If in the course of weighing you want to find out whether a particular measurement value is higher than the MSW value, specified for a given weighing range, then <Minimum sample weight> function must be on. To turn the function on go to weighing mode settings.

Procedure:

1. Press grey workspace area.
2. The following submenus are displayed: Settings, Buttons, Information, Printouts, Profile.
3. Select <Settings> menu - additional weighing process options.
4. Press  Minimum sample weight> field.
5. Wait for Minimum sample weight window to open. 6. Press <Method> field,

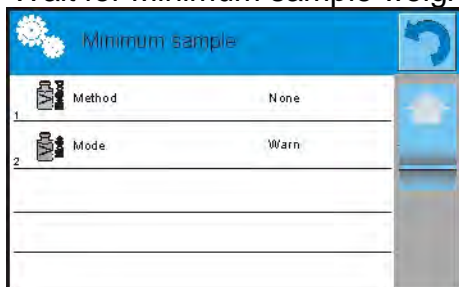

window with a list of database-stored methods opens.

6. Select respective method.
7. Previous menu is displayed.
8. Press <Mode> parameter.
9. Settings box is displayed, select respective option:
 - Block** – select to display pictograms informing you on status of weighed mass (weighed mass below/above minimum sample weight) and to disable accepting the measurement result if it is below the minimum sample weight limit.
 - Warn** – select to enable display of respective pictograms informing you about the measured mass (whether it is lower than the MSW value or higher than the MSW value). You can accept the measurement that is lower than the MSW value. Mind that on a printout it will be preceded by an asterisk (*).
10. Set the parameters and exit the menu.
11. Section presenting the weighing result comprises additional pictogram providing supplementary information. The pictogram changes in the course of weighing operation, it informs you on the weighed sample mass; the information is referred to the declared minimum sample weight value.

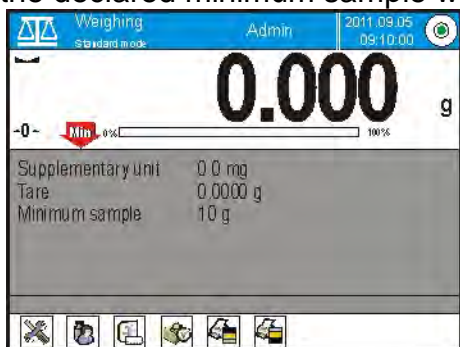



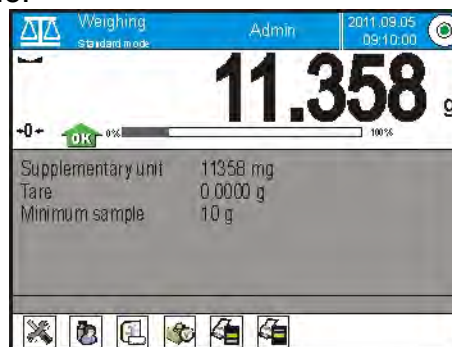

Weight value lower than the MSW value specified for a particular tare range.



Weight value higher than the MSW value specified for a particular tare range.

Pictograms providing MSW-related information:

| | |
|---|---|
|  | Weight value lower than the specified MSW value. |
|  | Weight value higher than or equal to the specified MSW value. |
|  | Weight value lower than the specified MSW value. A pictogram with a clock informs on expiry of the minimum sample weight validity period (it is displayed two weeks before the determined expiry date). |
|  | Weight value higher than the specified MSW value. A pictogram with a clock informs on expiry of the minimum sample weight validity period (it is displayed two weeks before the determined expiry date). |
|  | The validity period of the minimum sample weight has expired. The minimum sample weight settings need to be modified. The minimum sample weight settings can be modified by an authorized RADWAG personnel exclusively. |

CAUTION:

If more than one reference tare value is programmed (with corresponding minimum sample weight mass) then the indicated value automatically moves to a range corresponding to the weight of the tared container. At the same time the required minimum mass is changed.

16.9. Cooperation with Titrators

In order to provide correct cooperation with TITRATORS, go to settings of standard printout content and set <Mass value for a titrator> parameter to <Yes> value. With this, other variables for the printout are turned off.

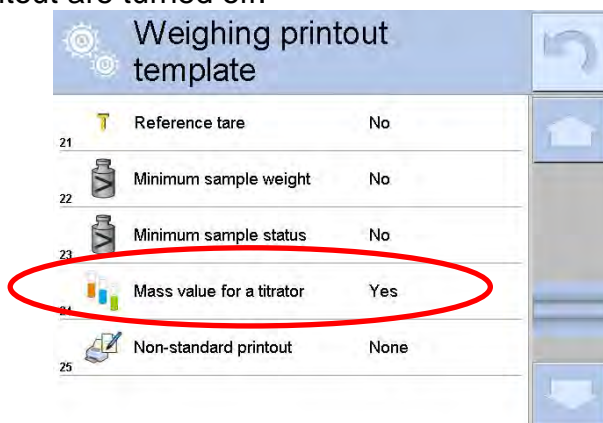

The pictogram informs on special format of mass printout, permissible by TITRATORS.

16.10. Ambient Conditions - Vibrations

Vibrations are a major cause of errors. Since the vibrations spread in all directions, the vibrations analysers and meters must carry out measurement in three axes concurrently. Ambient conditions module implemented in RADWAG balances of 4Y series features such option.

Analytical balances are precise weighing instruments therefore even insignificant oscillations influence their operation. Humans are most often unable to sense vibrations. In order to detect them, it is necessary to use special equipment. Vibrations sensor, along with a module that analyses the influence of the vibrations onto the measurement, informs the user in a real time on the possibility of occurrence of error caused by high-frequency vibrations. Usually the vibrations are dampened with use of anti-vibration tables. Signalling device, i.e. ambient conditions module equipped with a vibrations sensor, is used to support the process of vibrations dampening. Such device comes standard with each 4Y series balance. With use of the said signalling device it is possible to evaluate workstation conditions and if necessary to find more convenient place of use. It is often impossible to find a place where no vibrations occur, however the signalling device allows the operator to determine when and where to expect vibrations of the lowest-frequency.

Due to the following 3 factors: specified values of free vibrations, resolution, and permissible weighing instrument errors, the analysis must be carried out with regard to the right effective value (rms value) and bandwidth. Such analysis is performed on each 4Y series balance in a real time.

In case of the module that is in-built into balances manufactured by RADWAG, the filters analyse those frequencies to which the weighing devices are sensitive. In case of balances, effective value (rms value) measured from 3 axes and for a particular time interval is given, such value provides information on amplitude and history of disturbances.

Radwag has designed analysis method and selected permissible vibrations thresholds respectively to make signalling device operation both effective and convenient (not troublesome). Balance screen displays balance-registered vibrations level in percent.

Vibrations threshold cannot be changed, however the operator can modify settings in a way ensuring that alerts are displayed in the most convenient way, depending on the needs. By default the set value is 100%.

Example of settings modification:

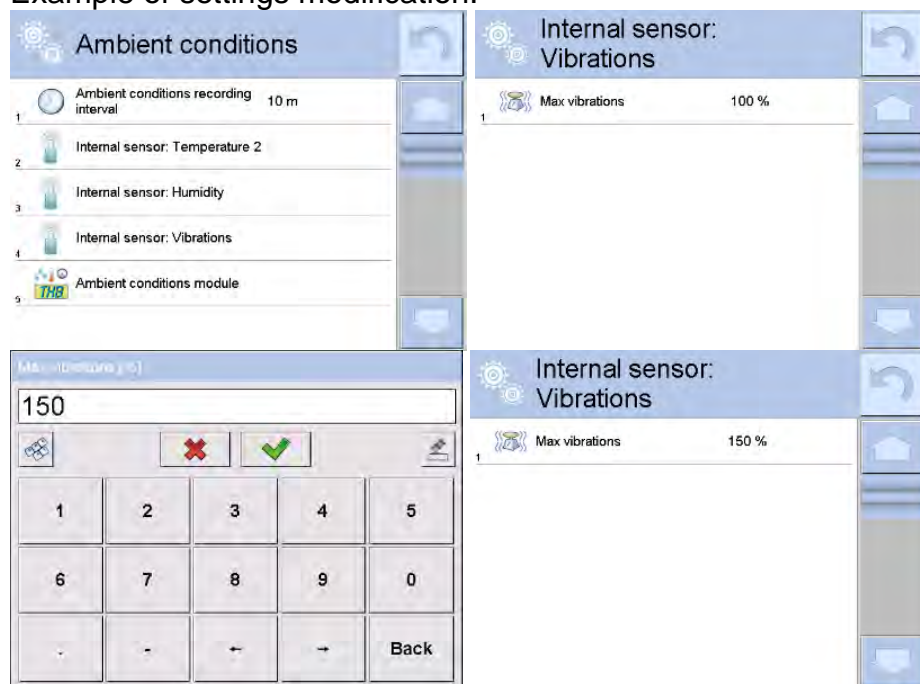

For better understanding, analyse the following example (the values used below are exemplary ones, they were not taken from the balance).

1. Assumed vibrations threshold set by default on 4Y series balance: 100mm/s².
2. Max vibrations value: 100% (threshold for alert display – pictogram colour change, from green to red). Pictogram colour is green for vibrations within 0 - 100mm/s² range, for vibrations value of 101mm/s², the pictogram changes to red.
3. Max vibrations value: 150%. Pictogram colour is green for vibrations within 0 - 150mm/s² range, for vibrations value of 151mm/s², the pictogram changes to red.

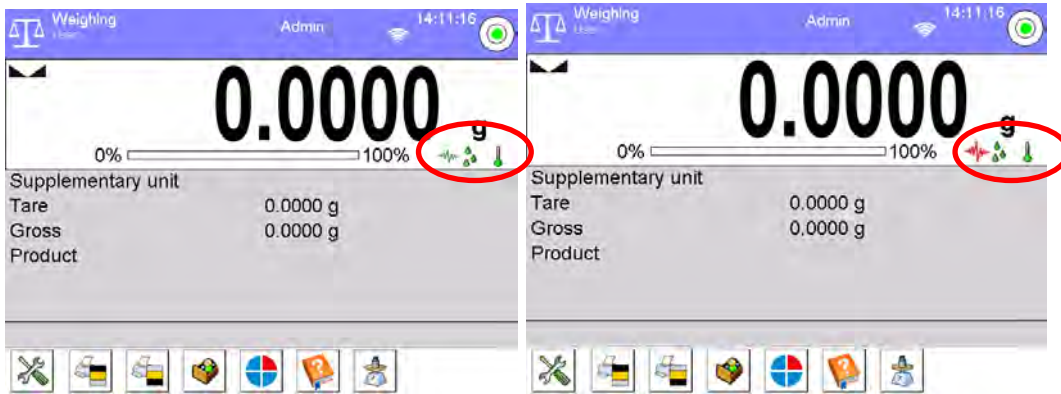

Vibrations are signalled by a respective pictogram displayed in the weighing result window.

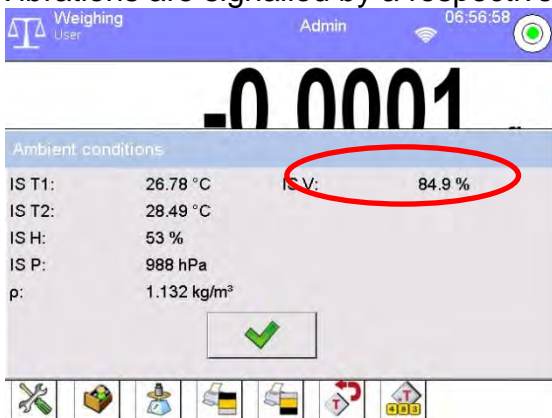

Upon pressing vibrations pictogram, window with current values measured by sensors is displayed. Displayed vibrations value (IS V) is the effective value registered within the most recent 2 seconds. This value is refreshed every 2 seconds. If the screen displays 100% value, this means that vibrations have reached threshold set by RADWAG.

Vibrations are recorded in the database, this allows to analyse history of ambient conditions quality.

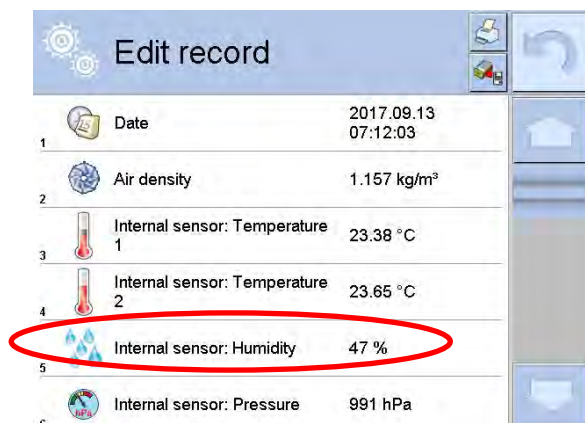
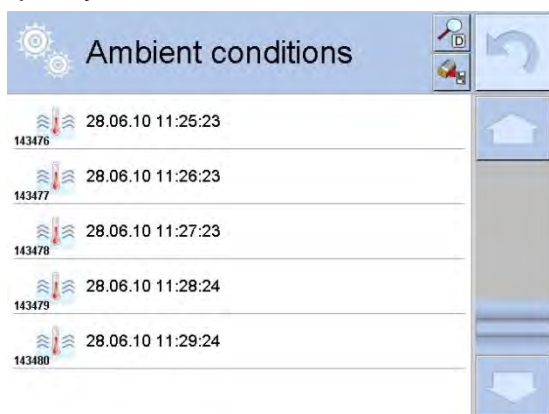

Effective value of vibrations registered by the balance over a declared time interval is saved (from the moment of the last record) – Setup/Ambient conditions/Ambient conditions recording interval.

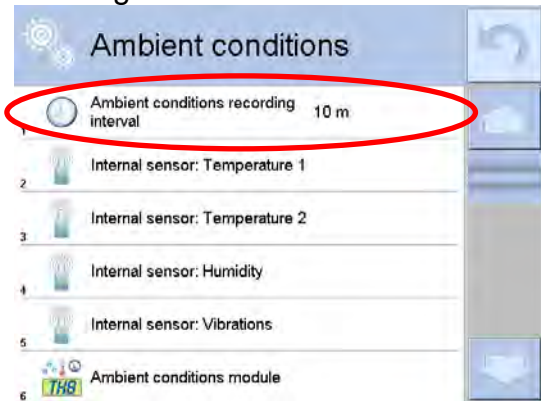

By default the interval is set to 10 min, this value may range between 1 min - 60 min. Record analysis allows the user to select optimal time of the day for the measurement performance, i.e. time when the environmental conditions (vibrations) influence the measurement the least. Mind that there are places where the most convenient working conditions occur after-hours.

Along with each measurement, data on ambient conditions alerts and level of vibrations, that occurred in the course of the measurement, is saved.

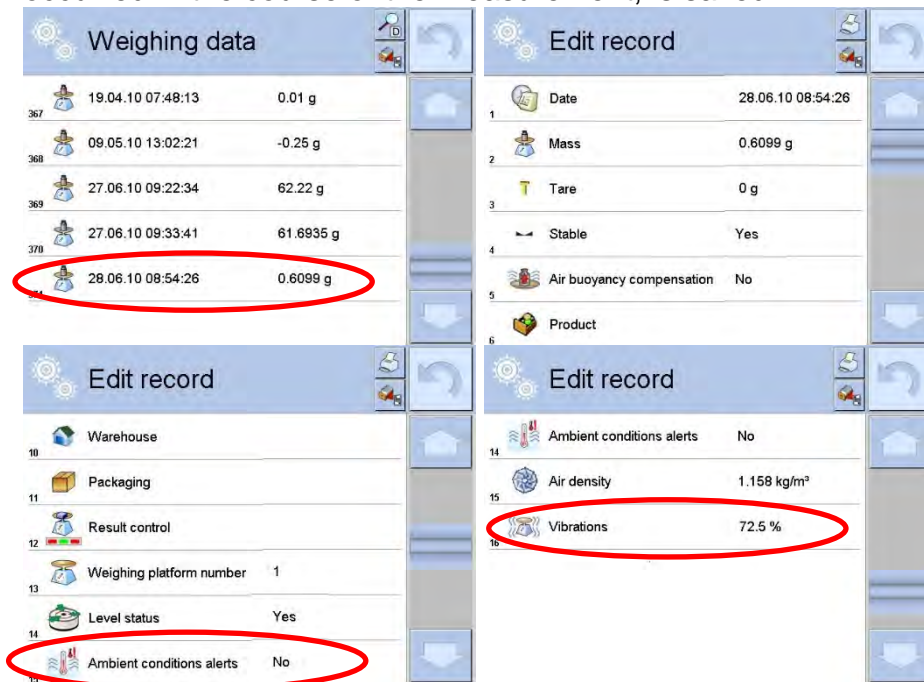

17. MAGNETISM

CAUTION: Prior to measurement, carry out internal adjustment.

Prior to measurement, set mass standard support plate depending on the test weight, so that the distance between the test weight and the magnet is compliant with the requirements.
For mass standards of class E1 - 20 mm distance (marking Z1 on the plate).
For mass standards of class E2- 27 mm distance (marking Z2 on the plate).
For mass standards of class F1 and F2 - 43 mm distance (marking Z3 on the plate).

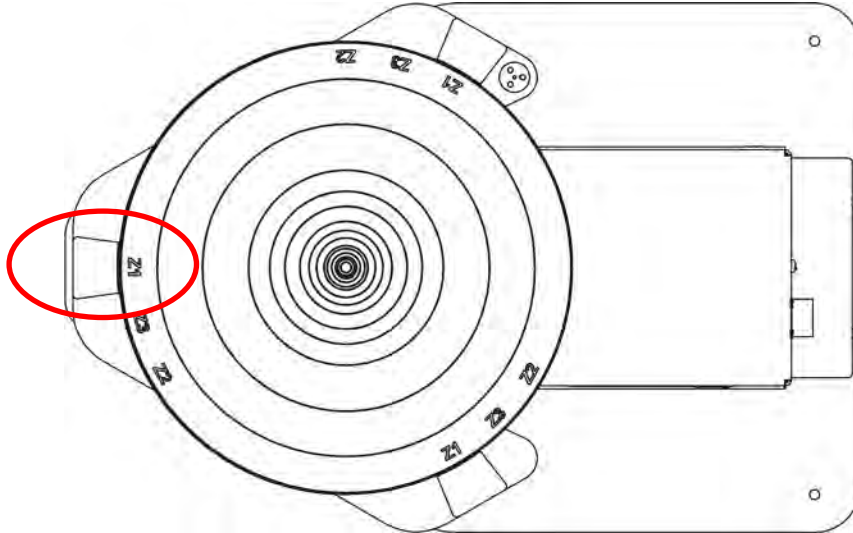

Enter respective settings in the program, according to the test weight: class, height, diameter and mass of the test weight.
If a series of test weights of the same class and dimensions is to be tested, determine and enter their quantity in <Test weights quantity> parameter.

| Settings | | |
|----------|-----------------------|-----------------|
| 1 | Weight class | E2 (Z2 = 27 mm) |
| 2 | Weight height | 0 mm |
| 3 | Weight diameter | 0 mm |
| 4 | Weight mass | 0 g |
| 5 | Test weights quantity | 1 |
| 6 | Print report | Yes |

| Settings | | |
|----------|-----------------------|-----------------|
| 1 | Weight class | E2 (Z2 = 27 mm) |
| 2 | Weight height | 66 mm |
| 3 | Weight diameter | 48 mm |
| 4 | Weight mass | 1000 g |
| 5 | Test weights quantity | 1 |
| 6 | Print report | Yes |

Upon entering respective values, you can return to the home screen and carry out weighing.

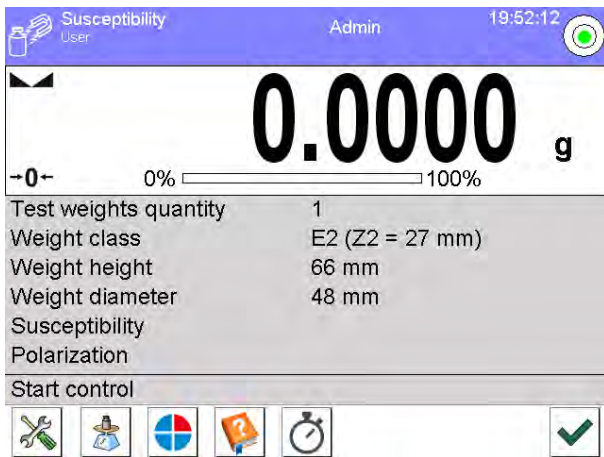

Press  button.



A message to set the magnet to position 1 is displayed. Press  button to confirm. The indication is automatically zeroed and the first step of the procedure is started. A message to load the test weight onto the spot marked on the bracket plate is displayed.





Wait for a stable indication and press  button to confirm. The measurement is saved to the database. The following message is displayed:

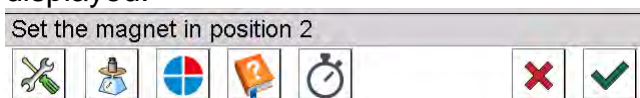

Unload the plate, wait until zero is displayed. Load the weight again, wait for indication stabilization and confirm the measurement. Repeat the procedure. Carry out 3 measurements for the first position of the magnet.

Upon confirmation of the third measurement, message to change magnet position is displayed.



Remove the plate, change magnet position, install the plate in the previous position and press  button to confirm.

The indication is automatically zeroed and the next step of the procedure is started. A message to load the test weight onto the spot marked on the mass standard support plate is displayed.



Upon magnet position change, carry out 3 subsequent measurements.

Upon the last measurement confirmation, respective calculations are automatically carried out. The results are displayed on the grey workspace and saved to <Susceptibility: reports> entry. If report printout option is selected in the settings, the report is automatically printed.

| | |
|-----------------------|------------------|
| Test weights quantity | 1/1 |
| Weight class | E2 (Z2 = 27 mm) |
| Weight height | 66 mm |
| Weight diameter | 48 mm |
| Susceptibility | -2.4969 |
| Polarization | 270.3601 μ T |
| Completed | |



Prior to next measurement press  button to confirm.

If a series of test weights is to be measured, set respective value in <Test weights quantity> parameter.

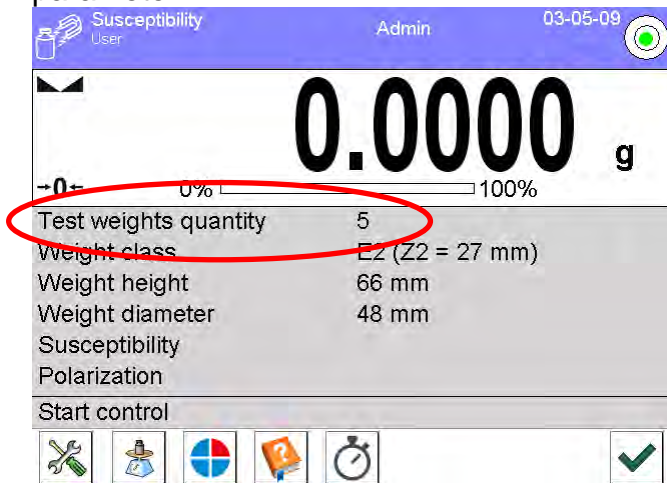

If the value is different than 1, carry out measurement of all test weights contained in one series for the first position of the magnet. Then change magnet position to 2 and carry out the measurement of test weights. Remember to carry out the measurement in the same order as for the first position of the magnet.

Load test weight B1: 1/6



Remove loaded object











Load test weight B2: 1/6

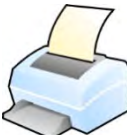

18. DATABASES

The module features the following databases <  >:

| | | |
|---|---|---|
|  WEIGHING RECORDS |  CUSTOMERS |  SUSCEPTIBILITY: REPORTS |
|  MINIMUM SAMPLE WEIGHT |  AMBIENT CONDITIONS |  WAREHOUSES |
|  PRINTOUTS |  UNIVERSAL VARIABLES |  MANAGE THE DATABASE |

18.1. Database Connected Operations

Databases can be operated only by an authorized personnel.

Procedure:

- Press and hold respective database pictogram.
- Database menu is displayed.
- Select one of the available entries (entries set is conditioned by a database).

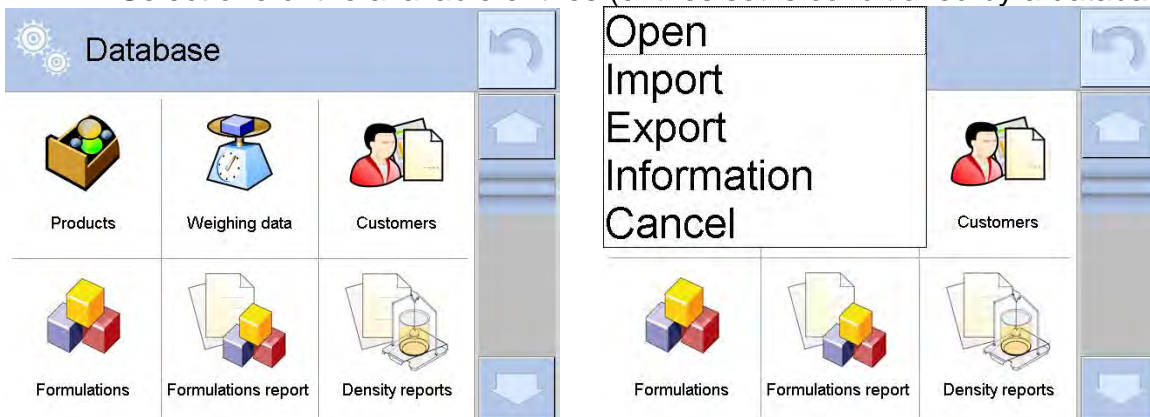

Entries:

- OPEN – select to enter a database (alternative method for database entering: a single click on given database field).
- IMPORT – select to import data from a USB flash drive. Plug the USB flash drive to a USB port, upon its detection a window with a list of saved files is displayed. Select file with data to be imported. The copying starts automatically. Upon completion of the process message: <Completed> is displayed. Confirm completion.







- EXPORT - select to export data from selected database to a USB flash drive. Plug the USB flash drive to a USB port, upon its detection the software automatically starts a copying process. Upon completion of the copying process a window with both, a file name to which data has been saved and message: <Completed> is displayed. Confirm completion.
- INFORMATION – select to display information about database content (see the figure below).



Press the button to return to the previous window.

- CANCEL – select to return to the home screen.

List of typical database operations:

1. Adding entry to a database <  >.
2. Searching for a record in a database by name <  >.
3. Searching for a record in a database by code <  >.
4. Searching for a record in a database by date <  >.
5. Exporting database content to a USB flash drive via USB port <  >.
6. Printing data on a specific record in a database <  >.



The above processes are carried out by pressing dedicated soft keys located on the top of the display. Follow the displayed commands.

18.2. Weighing Records

Each weighing result sent from the weighing device to a printer is saved to weighings database.

You can preview data of particular weighings.

Procedure:

- Enter <  **Databases** > submenu.
- Enter <  **Weighing records** > database and press respective record.

List of parameters defined for a weighing record :



1. Performed weighing date.
2. Measurement result.
3. Tare value.
4. Determination of measurement status (stable / unstable).
5. Determination of control of air buoyancy compensation (enabled/disabled)

6. Product name.
7. Operator.
8. Customer, customer name.
9. Working mode name.
10. Warehouse, source warehouse name.
11. Packaging, name of tare applied during product weighing.
12. Result control, information regarding range within which the weighed product is placed:
 - MIN – below LOW threshold (possible only if <Result control> is set to <NO> value),
 - OK – between the LOW and HIGH thresholds,
 - MAX – above HIGH threshold (possible only if <Result control> is set to <NO> value).
13. Weighing platform no., field denoting number of a weighing instrument using which a measurement was carried out,
14. Levelling, information on level status maintained during the measurement,
15. Ambient conditions alerts, information regarding stability of temperature and humidity during the measurement.

18.3. Customers

Customers database contains name of Customers for whom the measurements are carried out.

Procedure:

- Enter  Databases> submenu and press <Customers> entry.
- Press  Add> button to add a new customer to the database, or
- Select already existing customer

List of parameters defined for a customer:

1. Customer name
2. Customer code [internal code identifying a customer]
3. TIN
4. Address
5. Postal code
6. City
7. Discount
8. Printout [type of printout, customer-related label]

18.4. Susceptibility: Reports

Susceptibility reports provide information about susceptibility determination. Each report can be previewed, searched by name, date, code or exported and printed out.

Procedure:

- Enter  Databases> submenu and press <Susceptibility: reports> entry.
- Select report, if not visible, scroll the list using navigation buttons.
- Report is named by date and time; e.g. 18.07.12 15:12:15.

CAUTION:

It is possible to use 'search report' option.

List of susceptibility reports data:

1. Start date
2. End date
3. Operator
4. Susceptibility
5. Susceptibility status
6. Polarization
7. Polarization status



18.5. Minimum sample weight

Minimum sample weight database contains data concerning declared methods and minimum sample weights.

Caution:

Only authorized RADWAG personnel can add new minimum sample weight records or make changes in those stored in the database.

Procedure:

- Enter  Databases> submenu and press  Minimum samples weights> entry.
- Press  Add> button to add a new minimum sample weight, or
- Select already existing weight.

List of parameters defined for minimum sample weights:

1. Name - name of a method used to determine minimum sample weight.
2. Code - method code.
3. Description - method overview.
4. Subsequent control - a field for entering expiry date of the minimum sample weight. 2 weeks before the expiry date, a pictogram of a clock is displayed next to the status pictogram. The pictogram informs about the expiration date. Contact RADWAG representative to carry out necessary changes in minimum sample weight settings.
5. Thresholds – option that enables entering data on minimum sample weight mass and range of packaging mass (tare) with applicable criteria:

Tare – maximum tare value, for which the minimum sample weight is obligatory.

You can enter three characteristic quantities: 0.000g, optional mass within weighing instrument's measuring range, and maximum capacity (see: examples below).

Minimum mass – value of the minimum sample weight determined for a particular weighing device on site with use of respective method.

Example no. 1 XA 220.4Y balance, d=0.0001 g:

List of MSW values determined for the following packaging values:

| No. | Tare value | Minimum sample weight | Overview |
|-----|------------|-----------------------|--|
| 1 | 0.0000 g | 0.1000 g | Minimum sample weight refers to all net weight values when weighing is carried out without use of a tare container (<TARE> button NOT used). |
| 2 | 10.0000 g | 1.0000 g | Minimum sample weight refers to all net weight |

| | | | |
|---|------------|----------|--|
| | | | values when weighing is carried out using a tare container of mass ranging from 0.0001 g to 10.0000 g inclusive (<TARE> button used). |
| 3 | 50.0000 g | 2.5000 g | Minimum sample weight refers to all net weight values when weighing is carried out using a tare container of mass ranging from 10.0001 g to 50.0000 g inclusive (<TARE> button used). |
| 4 | 200.0000 g | 4.0000 g | Minimum sample weight refers to all net weight values when weighing is carried out using a tare container of mass ranging from 50.0001 g to 200.0000 g inclusive (<TARE> button used). |

Example no. 2 XA 220.4Y balance:

| No. | Tare value | Minimum sample weight | Overview |
|-----|------------|-----------------------|---|
| 1 | 220.0000 g | 0.5000 g | Minimum sample weight refers to all net weight values when weighing is carried out using a tare container of mass value comprised within the whole weighing range (<TARE> button used), and to all net weights that are weighed without a packaging (the <TARE> button not used). |

Example no. 3 XA 220.4Y balance:



| No. | Tare value | Minimum sample weight | Overview |
|-----|------------|-----------------------|---|
| 1 | 0.0000 g | 0.2500 g | Minimum sample weight refers to all net weight values when weighing is carried out without use of a tare container (<TARE> button NOT used). In case of such settings, the minimum sample weight is valid only when you weigh samples without use of tare containers. If taring function is used then pictogram informing on use of minimum sample weight goes blank and the software carries out weighing with tare (no determined minimum sample weight). |

You can preview the entered data, but you are not allowed to edit it.

18.6. Ambient Conditions

<Ambient conditions> database contains parameters related to ambient conditions. Depending on the balance type the ambient conditions report can show values of temperature, humidity, atmospheric pressure. If the given balance is connected to a THB module then its indications are recorded to the database too.

Procedure:



- Enter  Databases> submenu and press  Ambient conditions> entry.
- Select report, if not visible, scroll the list using navigation buttons.
- Report is named by date and time.

Caution: It is possible to use 'search report' option.

18.7. Warehouses

Depending on the organization of work, the warehouses database contains list of places used for picking up a sample for weighing or list of places to which a weighed sample was delivered. Each warehouse has to have its name, code and description specified. During weighing process, and on selecting name of a warehouse, it is automatically assigned to the measurement result.

Procedure:



- Enter <  Databases> submenu and press <  Customers> entry.
- Press <  Add> button to add a new warehouse, or
- Select an already existing warehouse.

Caution: It is possible to use 'search report' option.

18.8. Printouts

Printouts database contains all NON-STANDARD printouts. Each printout features a name, code and a template.

Procedure:

- Enter <  Databases> submenu and press <  Customers> entry.
- Press <  Add> button to add a new printout, or
- Select an already existing record.

Caution: It is possible to use 'search report' option.

Designing new printout template

Procedure:

- Enter <  Databases> submenu and press <  Customers> entry.
- Press <  Add> button to create a new printout, or edit an already existing one.

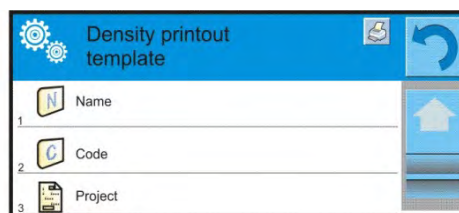
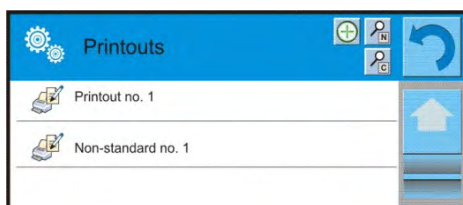

- Edit box opens, press <Project> entry.
- Respective box with an on-screen keyboard is displayed.
- Use the keyboard and create printout template.

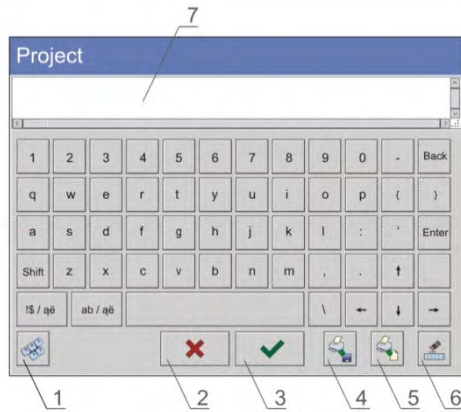

- 1 – zoom the edit box (7), recommended while using an external computer keyboard connected to module’s USB port,
- 2 – cancel
- 3 – confirm
- 4 – download a printout template from a file
- 5 – list of variables
- 6 – delete all printout content
- 7 – edit box

- Save designed printout.

CAUTION:

To delete characters press Back key. To move cursor, press navigation keys.

Example of Printout no. 1 – large edit box

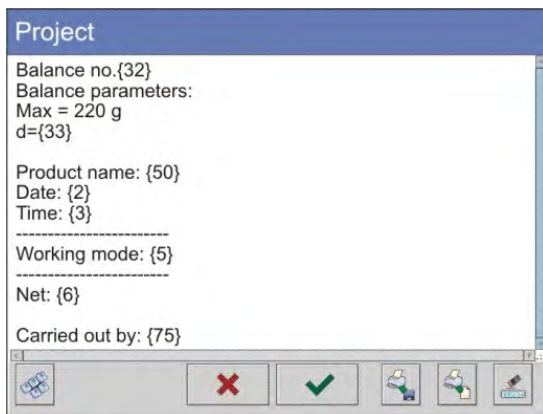

Project

Module no. 400015
 Module parameters:
 Max = 220 g
 d= 0.001 g

Product name:
 Date: 2011.10.24
 Time: 11:48:06

 Working mode: Weighing

 Net weight: 94.147

Carried out by: Admin

Printout template

Example of Printout no. 2 – printout from a file

All printout templates can be designed in a form of external files, that are imported to a balance; file extension: *.txt or *.lb. External file shall contain all constant and variable data. Upon importing, the content of a printout template can be modified.

Procedure:



- Design a *.txt or *.lb file in an optional editor.
- Copy the file to a USB flash drive.
- Connect the USB flash drive to module’s USB port.

- Press [4] <  Download a printout from a file> button,
- Module's display shows data stored on the USB flash drive connected to the USB port.
- Select a file with printout template and press its name.
- The printout template is automatically copied to an editing field.

18.9. Universal Variables

Universal Variables are alphanumeric data which can be combined with printouts, products or other comparison-related information. Each variable has to have its name, code and value specified.

Procedure:

- Enter <  Databases> submenu and press <  **Var** Customers> entry.
- Press <  Add> button to add new variable, or
- Select already existing universal variable, and modify the following fields: code, name, value.

CAUTION:

It is possible to use 'search report' option.

18.10. Databases Management

Function allowing to manage databases data. It comprises three options: Export weighing database, Delete databases and Delete weighments and reports.

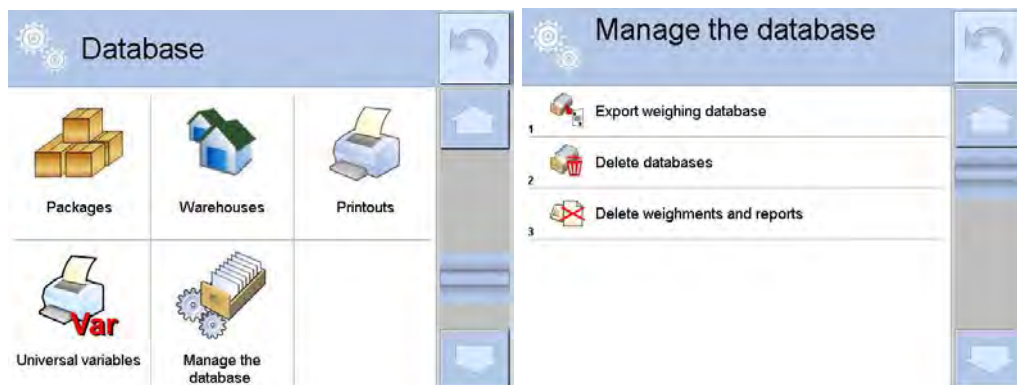

18.10.1. Export Weighing Database to a File

All measurements are saved to <Weighing records> database and can be exported to a file using a USB flash drive.

Procedure:

- Connect the USB flash drive to USB A port.
- Press <  Export weighing records database to a file> entry, a window for setting export options is opened.



<Data selection> parameter allows you to specify which data related to measurement is to be exported.



- Set respective data and press <Export weighing records database to a file> entry, weighing database is automatically exported.
- Upon export completion, message <Completed> along with information on number of exported data and with file name (with *.txt extension) is displayed. Next previous window is displayed.

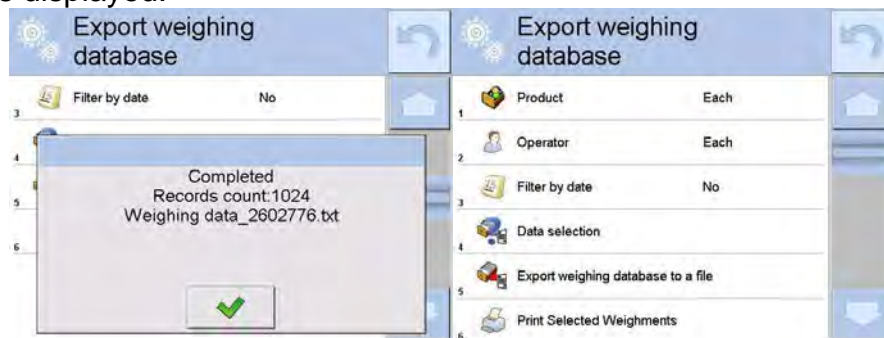

- You may return to weighing procedure or proceed to other settings.

CAUTION:

If balance software cannot identify the USB flash drive, then upon pressing <Export weighings database to a file> entry, <Operation failed> message is displayed.

- A name of created file consists of database name and balance serial number, e.g. <Weighing data_364080.txt>.
- Unplug the USB flash drive from the USB port.

Template of created file:

The file is created in a form of a chart, columns of which are separated with <Tab>. This allows for direct export of the file to <Excel> spread sheet document. The chart contains the following data: date and time, mass and mass unit, tare and tare unit, serial number, operator name, customer name, packaging name, source warehouse name, target warehouse name, control result name.

18.10.2. Delete Databases

Function allowing to delete data of selected database. Upon function activation, window with databases list is displayed, select database, delete respective data.

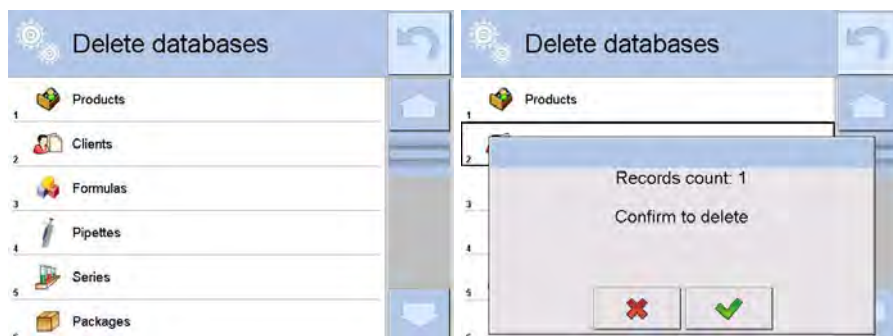

Upon confirmation, data is deleted and the following message is displayed:

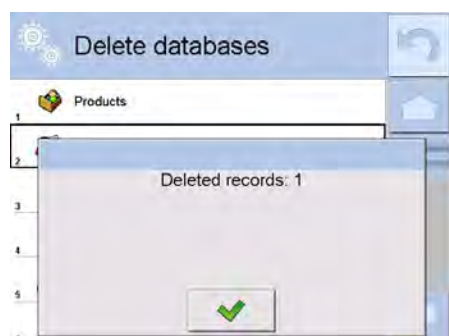

Upon confirmation the software returns to a previous window; you may continue weighing or proceed to other operations.

18.10.3. Delete Weighings and Reports

Function allowing you to delete weighings and reports of a given database. Activate <Delete weighing records and reports> parameter, a window with a numeric keyboard is displayed. Using the keyboard, enter a date specifying which data is to be removed. Date is given in the following form: year-month-day.



Confirm the date, all weighings and reports older than those specified by the date are removed. Quantity of deleted weighings and reports is displayed.

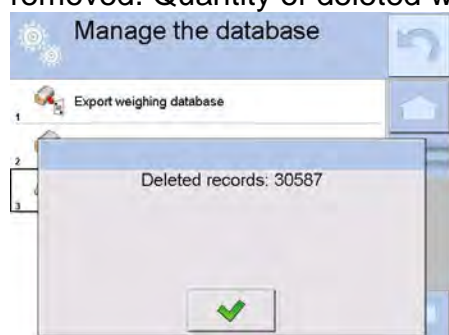



19. COMMUNICATION

Communication menu is located in <Parameters> menu. To access Communication menu press Setup key or <Setup  > quick access button. Communication between the balance and the peripheral devices is established via the following ports:

-  COM 1 (RS232),
-  COM 2 (RS232),
-  Ethernet
-  Wi-Fi,
-  TCP.

The ports are to be configured in < Communication> parameter.

Enter < Communication> parameter and press  key and next press: < Communication> button.

19.1. RS 232 Settings

Procedure:

- Select communication port < COM1> or < COM2>.
- Configure ports.

There are following transmission parameters for RS 232 ports:

- Baud rate: 4800, 9600, 19200, 38400, 57600, 115200 bit/s
- Data bits: 5, 6, 7, 8
- Stop bits: None, 1, 1.5, 2
- Parity: None, Odd, Even, Marker, Space

19.2. ETHERNET Settings

Procedure:

- Select communication port < Ethernet>. Set the following parameters:
- DHCP: Yes – No
- IP Address: 192.168.0.2
- Subnet mask: 255.255.255.0
- Default gate: 192.168.0.1

CAUTION:

Above settings are for information purpose only. Set the transmission parameters in accordance with your local network.

Upon completing modifications, press  button, the following message is displayed:
<Restart balance to implement changes>.

Return to weighing mode and restart the device.

19.3. Wi-Fi Settings

Balance equipped with Wi-Fi module displays respective pictogram:

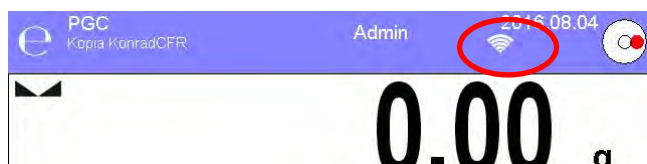

Procedure:

- Select <  Wifi > communication interface. Set the following parameters:
 - DHCP: Yes – No
 - IP Address: 10.10.9.155
 - Subnet mask: 255.255.255.0
 - Default gate: 10.10.8.244

CAUTION:

Above settings are for information purpose only. Set the transmission parameters in accordance with your local network.

Upon completing modifications, press  button, the following message is displayed:
<Restart balance to implement changes>.

Return to weighing mode and restart the device.

You may use <Available networks> parameter to view the list of networks detected by the module:

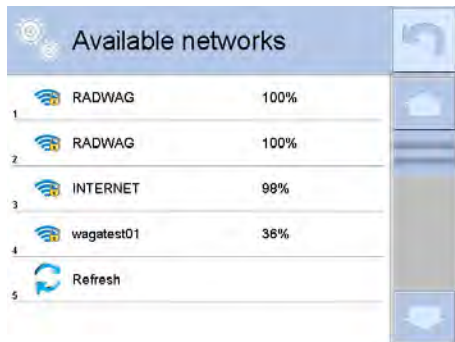

Pictogram with a padlock means that the password is required. Press <Refresh> pictogram to search for available networks.

Press <Network status> field to check selected network parameters. The window contains the following parameters:

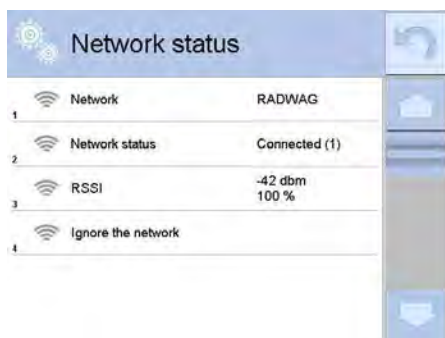





The selected network and connection parameters are saved to balance memory. The program connects to the network in accordance with the memory-saved parameters each time the balance is switched on. To change this, select <Ignore the network> option. Given network gets disconnected.

19.4. TCP Settings

TCP (*Transmission Control Protocol*) operating in customer-server mode enables communication of two computers. You can establish connection on port specified by server.



Procedure:

- Enter <Communication> parameter.
- Select <Tcp / Port>; a <Port> window with an on-screen keyboard is opened.
- Insert required port number and press  button to confirm.



20. PERIPHERALS

<Peripherals> menu is located in <Parameters> menu. To access Peripherals menu press Setup key or <Setup  > quick access button. Peripherals menu provides list of devices that can be integrated with the balance.

20.1. Computer

Active balance – computer connection is signalled by  pictogram (top bar of the home screen). <Computer> submenu enables configuration of connection settings.

Procedure:

- Press  key and next press < Peripherals/  Computer>.
- Set parameters related to cooperation with a computer.
 - Computer port
Available options: none, COM 1, COM 2, Tcp,
 - Address
Give address of balance connected to a computer,
 - Continuous transmission
Available options: NO, YES (*printout format is conditioned by set weighing printout template – see parameter below*),
 - Interval:
Parameter enables setting printout frequency for continuous transmission. Printout frequency is set in seconds, with 0.1s accuracy. You can set frequency in a range from 0.1 to 1000 seconds for continuous transmission activated using module and computer.
 - Printout template for weighing
Parameter enables printout customization that is to be carried out in a window with printout template (*for detailed information about creating printouts refer to section 30.19 of this user manual*).
 - E2R SYSTEM
E2R System performs supervision and control over all weighing processes carried out using mass comparator. With E2R system activated some databases can be operated using computer exclusively (access to specified functions and options using weighing instrument is not possible).

CAUTION:

< **E2R System**> can only be activated by balance manufacturer or by authorized personnel.

To provide correct cooperation with E2R System continuous transmission has to be activated.

20.2. Printer

<Printer> submenu allows you to:

- set port for establishing communication with printer,
- define printer's code page (by default: 1250),
- define control codes for PCL printer or EPSON receipt printer.

Caution: Codes must be entered in a hexadecimal form!

- define printout templates.

Speed of transmission respective for a printer (see: Printer settings) must be selected for the module to ensure its right cooperation with a printer (diacritical signs specified for a given language). Additionally code page of a sent printout must be accordant with a code page of a printer.

There are two methods for obtaining code page accordance:

- by setting the right code page in printer settings (read the printer manual) – respective to printout code page set in the balance; or
- by sending control code, from a balance to the printer, which automatically sets the right code page (respective to code page set in a balance) in advance before execution of the data printout – it is possible only for printers equipped with such option.

Exemplary balance settings for correct cooperation (printout of Polish signs) with EPSON thermal printer connected to RS232 port:

1. EPSON TM-U220x Dot matrix printer

Communication parameters for port to which the printer is connected:

- *baud rate* – 9600 bit/s
- *data bits* – 8
- *stop bits* – 1
- *parity* – none

Printer parameters set for PERIPHERALS group:

- *port* – COM 1 or COM 2 (the one to which the printer is connected)
- *code page* – **852**
- *control codes* – **1B7412**

2. EPSON TM-T20

Communication parameters for port to which the printer is connected:

- *baud rate* – 38400 bit/s
- *data bits* – 8
- *stop bits* – 1
- *parity* – none

Printer parameters set for PERIPHERALS group:

- *port* – COM 1 or COM 2 (the one to which the printer is connected)
- *code page* – 1250
- *control codes* – **1B742D**

Printer's parameters:

- *port* – COM 1 or COM 2 (the one to which the printer is connected)
- *code page* – **852**
- *control codes* – **1B7412**

If there are any unexpected signs on the printout in the place of the last digit (for verified balances), then <CONTROL CODES> parameter must incorporate, apart from the code page, code of the UK signs chart: **1B5203**. In such a case the <CONTROL CODES> parameter setting has to be as follows: control codes – **1B74121B5203**

A printout template describes how to print information from databases.

The template can be modified. In order to check format of printout template, print data related to e.g. product parameters. – function activated on moving to <Products/Edit product> database and pressing printer pictogram.

Default values for particular printouts:

| | |
|-----------------------------|-------|
| Product printout template | {50} |
| | {51} |
| Operator printout template | {75} |
| | {76} |
| Customer printout template | {85} |
| | {86} |
| Warehouse printout template | {130} |
| | {131} |
| Package printout template | {80} |
| | {81} |
| | {82} |

Ambient conditions printout template

```

----- AMBIENT CONDITIONS-----
Date and time      {275}
Temperature of sensor 1: {value} °C
Temperature of sensor 1: {value} °C
THBS temperature:   {value} °C
THBS humidity:     {value} %
-----
  
```

Formulation printout template

```

----- Formulation -----
Formulation name: {165}

      Ingredients quantity:      {167}
      Target mass:      {168} g
      Formulation ingredients:

      {169}
-----
  
```

20.3. Barcode Scanner

The balance is compatible with a barcode scanner. The barcode scanner is used to facilitate quick search for database records:

- Products,
- Operators,
- Customers,
- Packages,
- Warehouses,
- Formulations,
- Pipettes
- Series in a differential weighings
- Universal variables,

To configure barcode scanner enter:



„ /  **Peripherals** /  **Barcode scanner**”.

CAUTION:

Enter < **Communication**> submenu and set baud rate for a barcode scanner (by default 9600b/s). For detailed description of 'module' - 'barcode scanner' communication read **APPENDIX E** of this user manual.

20.3.1. Barcode Scanner Port

Procedure:

- Enter < **Peripherals**> parameter and go to „ **Barcode scanner** /  **Port**” parameter. Select respective option:

Ports for balance – scanner communication:

- RS 232 (COM1),
- RS 232 (COM2),
- USB





20.3.2.Prefix/Suffix

You can edit < **Prefix**> and < **Suffix**> to synchronize mass comparator’s software with barcode scanner.

CAUTION:

In RADWAG-adopted standard, the prefix is 01 sign (byte) hexadecimal format, the suffix is 0D sign (byte) hexadecimal format. For detailed description of 'module' - 'barcode scanner' communication read **APPENDIX E** of this user manual.

Procedure:











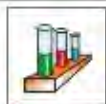

- Enter < **Barcode scanner**> submenu,
- Select < **Prefix**> parameter and enter hexadecimal value using the on-screen keyboard. Press  button to confirm.
- Select < **Suffix**> parameter and enter hexadecimal value using the on-screen keyboard. Press  button to confirm.

20.3.3.Field Selection







Parameter allowing you to specify, for which field the search is to be carried out in particular databases.

Procedure:

- Enter < **Peripherals**> submenu,
- Select „ **Barcode scanner** /  **Field selection**”. List of fields is displayed:

| | | | |
|---|-------------|---|-----------------------|
|  | Product |  | Series |
|  | Operator |  | Universal variable 1; |
|  | Customer |  | Universal variable 2; |
|  | Packaging |  | Universal variable 3; |
|  | Warehouse |  | Universal variable 4; |
|  | Formulation |  | Universal variable 5; |
|  | Pipette | | |

- Select one item from the list. The following parameters may be edited:

| | | |
|---|-----------------------|--|
|  | Filtering | Declaring search criteria (see table below) |
|  | Offset | Parameter allowing you to set the first significant code's character. All preceding characters are omitted. |
|  | Length of code | Declaring the quantity of code's characters to be taken into account during search procedure. |
|  | Start marker | Declaring the starting point of scanned code used for searching. |
|  | End marker | Declaring the ending point of scanned code used for searching. |
|  | Ignore marker | Determining whether start and end markers are to be used when comparing scanned code with the code saved to the balance. |

Filtering criteria conditioned by field type:

| Field Selection | Filtering |
|-----------------|----------------------------|
| Product | None, Name, Code, EAN code |
| Operator | None, Name, Code, |
| Customer | None, Name, Code, |
| Packaging | None, Name, Code, |
| Warehouse | None, Name, Code, |
| Formulation | None, Name, Code, |
| Pipette | None, Name, Code, |

| | |
|---------------------|-------------------|
| Series | None, Name, Code, |
| Universal variables | None, Active |

20.3.4.Test

 **<Test>** parameter allowing you to verify if operation of a barcode scanner connected to a balance is correct.

Procedure:

- Enter **<Barcode scanner>** submenu,
- Select **<Test>** parameter; **<Test>** edit box is displayed, it features ASCII and HEX fields.
- The code is scanned and entered to the ASCII field and HEX field, next the test result is displayed in the bottom part.

When:

- **<Prefix>** and **<Suffix>** declared in balance settings comply with **<Prefix>** and **<Suffix>** of the scanned code, the test result is **<Positive>**,
- **<Prefix>** and **<Suffix>** declared in balance settings do not comply with **<Prefix>** and **<Suffix>** of the scanned code, the test result is **<Negative>**,

20.4. Transponder Card Scanner

You can log in to the balance by means of:

- password entered using an on-screen keyboard,
- registered transponder card scanner.

CAUTION:

*For correct balance - transponder card scanner integration set appropriate baud rate value in **<Communication>** submenu (by default 9600b/s).*

Transponder card scanner port

Communication between the weighing device and the transponder card scanner can be established via the following ports:

- RS 232 (COM1)
- RS 232 (COM2)

In order to log in an operator via transponder card scanner, first assign a number of an already registered card to a selected operator in the database of operators.

Procedure:

- Connect a transponder card scanner to a given port (RS 232 COM1 or RS 232 COM2), select communication port for balance - transponder card scanner communication.
- Go to **<Communication>** submenu and set baud rate compatible with baud rate of the transponder card scanner (by default 9600b/s).
- Enter operators database, go to **<^{1,2..n}RFID Card no.>** parameter and edit desired operator's record.
- Upon entering editing mode in **<^{1,2..n}RFID Card no.>** parameter, a **<Card no.>** edit box is opened with an on-screen keyboard.

- Approximate the card to the transponder card scanner. The mass comparator automatically displays number of detected card in the <Card no.> field.
- Accept recognized number by pressing  button and return to weighing.





20.5. Additional Display

Communication between the weighing device and the additional display can be established via the following ports:

- RS 232 (COM1)
- RS 232 (COM2)
- TCP

Type of data displayed on an additional display is declared in <Project> variable.

Procedure – designing a variable:

- Enter  Peripherals> submenu.
- Select  Additional display/ Project> parameter, a <Project> edit box with an on-screen keyboard is displayed.
- Use the on-screen keyboard to insert desired value of a project, or press  > button and select respective value from the list.
- Press  button to confirm.

CAUTION:

*The balance cooperates with RADWAG WD5/3Y additional display. In order to ensure correct cooperation between the balance and the additional display, set **{140}** variable for  Project> parameter, next set 38400 bits/s baud rate for a port to which the additional display is connected.*

20.6. Ambient Conditions Module

Ambient conditions module (THB) can be connected to the balance via COM 1 or COM 2 port. In order to provide correct cooperation enter module's address and baud rate for the port (port settings) to which the ambient conditions module is connected (the address and baud rate are to be found on an ambient conditions module data plate).

20.7. Automatic Feeder

(function disabled for standard balance models)

Communication between the weighing device and the automatic feeder can be established via the following ports:

- RS 232 (COM1)
- RS 232 (COM2)
- Com internal.

To ensure correct integration with the feeder, set its address (the address and baud rate are to be found on the automatic feeder data plate).

21.INPUTS/OUTPUTS

Application of inputs:





The set of inputs is used to control module's operation. The following functions or keys can be assigned to each of 4 inputs:

- Checkweighing thresholds
- Target value
- Profile
- Adjustment
- Zero
- Tare
- Set tare
- Disable tare
- Restore tare
- Packaging
- Print
- Print header
- Print footer
- Universal variable 1÷ 5
- Accept
- Abort
- Operator
- Left door
- Right door
- Parameters
- Statistics
- Add to statistics
- Product
- Warehouse
- Customer
- Parts counting: set part mass
- Parts counting: Determine part mass
- Percent weighing: set reference mass
- Percent weighing: set 100%
- Solid density
- Liquids Density
- Air density
- Automatic Weight Crane Control
- Task
- Reference weight

Upon change of the logic state of the input system, e.g. from [0] to [1], a function that is assigned to the system is carried out. For instance:

- automatic balance adjustment,
- display of set checkweighing threshold values,
- restoring tare value.

Procedure:

- Press  key, next go to: <  Inputs/Outputs > button.
- Enter  < Inputs/Outputs > submenu and select <  Inputs > parameter.
- Edit a selected input; list of available functions is displayed.
- Select a given function and return to weighing.

Application of outputs:

Outputs are used to SIGNAL the status of measurement result. Change of logic status of the output system, e.g. from [0] to [1], takes place on meeting a requirement assigned to the output.



The following data can be assigned to each of 4 outputs:

| Option | Balance status switching output logic. |
|----------------------------------|--|
| None | ----- |
| Stable | Each stable measurement switches the logic state. |
| MIN stable | Stable measurement below [MIN] threshold switches the logic state. |
| MIN unstable | Unstable measurement below [MIN] threshold switches the logic state. |
| OK stable | Stable measurement within [MIN] [MAX] thresholds switches the logic state. |
| OK unstable | Unstable measurement within [MIN] [MAX] thresholds switches the logic state. |
| MAX stable | Stable measurement above [MAX] threshold switches the logic state. |
| MAX unstable | Unstable measurement above [MAX] threshold switches the logic state. |
| Confirmation of cycle completion | End of procedure. |

Procedure:

- Press  key, next go to:  <Inputs/Outputs> button.
- Enter  <Inputs/Outputs> submenu and select  <Inputs> parameter.
- Edit a selected output; list of available functions is displayed.
- Select given function from the list, next return to weighing and save changes.

22. MISCELLANEOUS PARAMETERS

This menu contains parameters facilitating balance operation. language, date-time, beep sound, display adjustment, level control. To enter <Misc.> submenu, press  key, next press  <Misc.> button.

22.1. Interface Language

Procedure:

Enter  < Misc.> submenu.



Select  <Language> parameter and select language.

Available languages: Polish, English, German, French, Spanish, Korean, Turkish, Chinese, Italian, Czech, Romanian, Hungarian, Russian.

22.2. Date and Time





You can set date, time and their formats.

There are two ways to edit date and time settings:

- Press **<Date and time>** entry (home screen's top bar).
- Go to   / **Misc.**  / **Date and time** parameter.

Enter date and time settings, an on-screen keyboard is displayed. Set date and time: year, month, day, hour, minute. Press  button to confirm.

Additional functions of:   **Misc.** /  **Date and time** submenu:

| Pictogram | Name | Value | Description |
|---|--|---|--|
|  | Time zone | (UTC+01:00) Sarajevo, Skopje, Warsaw, Zagreb | Parameter value: name of time zone/country, which informs of summer/winter time change. The information comes from Microsoft website. |
|  | Automatically adjust clock for daylight saving | Yes | Function enables or disables automatic clock adjustment. Upon parameter change restart the balance. |
|  | Date and time | 2016.04.04 08:00:00 | Mass comparator's date and time setting |
|  | Date format | yyyy.MM.dd * | Enter this parameter to set internal clock and date. Options: d.M.yy, d/M/yy, d.M.yyyy, dd.MM.yy, dd/MM/yy, dd-MM-yy, dd.MM.yyyy, dd/MM/yyyy, dd-MMM-yy, dd.MMM.yyyy, M/d/yy, M/d/yyyy, MM/dd/yy, MM/dd/yyyy, yy-M-dd, yy/MM/dd, yy-MM-dd, yyyy-M-dd, yyyy.MM.dd, yyyy-MM-dd. |
|  | Time format | HH:mm:ss ** | Enter this parameter to set time format. Options: H.mm.ss, H:mm:ss, H-mm-ss, HH.mm.ss, HH:mm:ss, HH-mm-ss, H.mm.ss tt, H:mm:ss tt, H-mm-ss tt, HH.mm.ss tt, HH:mm:ss tt, HH-mm-ss tt, h.mm.ss tt, h:mm:ss tt, h-mm-ss tt, hh.mm.ss tt, hh:mm:ss tt, hh-mm-ss tt |

*) - For date format: y – year, M – month, d – day

***) - For time format: H – hour, m – minute, s – second

 <Date and time> parameter enables preview of declared date and time formats.

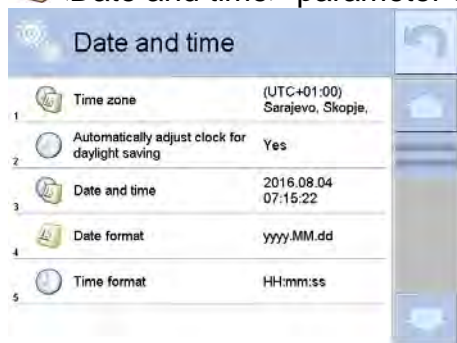



CAUTION:

< Date and time> parameter can be accessed only by an operator with appropriate permissions. Permissions level can be modified by administrator in <Permissions> menu.

22.3. „Beep” Sound

Procedure:

Enter  < Misc.> submenu, select  < Beep> parameter and set appropriate value:

| | |
|--------------|--|
| None | - Beep sound disabled for keys/buttons and proximity sensors |
| Keys/Buttons | - Beep sound enabled for keys/buttons |
| Sensors | - Beep sound enabled for proximity sensors |
| All | - Beep sound enabled for keys/buttons and proximity sensors |

22.4. Volume

You can change volume of the loudspeaker mounted in the weighing indicator.

Procedure:

Press  key, next go to:  < Misc./Volume> parameter.

An on-screen keyboard is displayed. Enter volume in percent: 100% - maximum volume, 0% - minimum volume (loudspeaker off).

22.5. Sleep Mode

You can turn on display sleep mode.

Procedure:

Press  key, next go to:  < Misc./Display sleep mode> submenu.

Select one of the following options: [None; 1; 2; 3; 5; 10; 15]. Digits stand for minutes. The software returns to the previous menu.

CAUTION:

Display turns to sleep mode only when the balance is not operated (the indication on the screen remains the same). Upon mass change, or pressing any key on the panel, the mass comparator returns to weighing.

22.6. Display Brightness

Display brightness influences duration of battery-powered balance operation. To make the balance work longer, reduce screen brightness.

Procedure:



Press  key, next go to:  < Misc./Display brightness> submenu.

Enter desired value: [0% - 100%]. Display brightness changes automatically, the previous menu is displayed.

22.7. Touch Panel Calibration

Display calibration is required if the touch panel does not react correctly during operation.

Procedure:

- Enter  < Misc.> submenu.
- Select  < Touch panel calibration> parameter, an edit box is displayed.
- Use finger or a thin soft stylus to press and hold a display area with a cross. After pressing the fifth cross in order, accept the changes by pressing  key.

CAUTION: *The process can be aborted by pressing Esc key on an external keyboard connected to the balance indicator.*

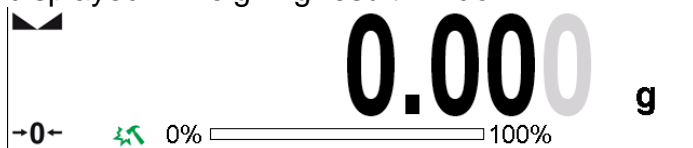

22.8. Vibrations Detection

The program detects incorrect loading of the weighing pan with the sample, which can lead to increased indication errors. Function activation is signalled by a respective pictogram displayed in weighing result window.



If incorrect loading of the weighing pan with the sample is detected, the pictogram turns to red . In a consequence the measurement result may be affected by a greater error.

Procedure:



- Enter <  Misc.> submenu.
- Select <  Vibrations detection> parameter,
- Select one of available options:
 - Yes – function on
 - No – function off

22.9. Level Control

The balance is equipped with Automatic Level Control mechanism. You can define its operation for non-verified devices.

In case of verified instruments, the settings are hidden and the balance operates in accordance with factory settings, i.e. <Active with lock>. Weighing process is possible only if balance is properly levelled.

Procedure:

- Enter <  Misc.> submenu.
- Select <  Level control> parameter, an edit box is displayed.
- Select one of available options:
 - None – level indicator not displayed, the balance does not control level status,
 - Active – level indicator displayed, level status is signalled by colour (green→ OK, red→ levelling required),
 - Active with lock – level indicator displayed, level status is signalled by colour (green→ OK, red→ levelling required). For red level indicator 'no Level' alert is displayed - weighing function is blocked.

Caution: For detailed information on balance levelling refer to section 16.3 of this user manual.

22.10. Proximity Sensors Sensitivity

The parameter is adjustable between 0 – 9, and it determines the distance from which the IR proximity sensors react.

Default value ranges between 5 and 7.

Procedure:

- Enter < Misc.> submenu.
- Select <Proximity sensors sensitivity> parameter, an edit box is displayed.
- Select one of available options. The selection causes immediate returning to the menu window.

22.11. Proximity Sensors Timeout

Parameter for setting timeout of proximity sensors expressed in [ms].

Default value: <0>.

When you use the option of motion recognition set <Proximity sensors timeout> parameter to <500ms> value.

Procedure:

- Enter < Misc.> submenu.
- Select <Proximity sensors timeout> parameter, an on-screen keyboard is displayed.
- Enter <500> value.
- Confirm. Menu is displayed.

22.12. Autotest



<AUTOTEST> function has been designed to help you assess balance operation and to diagnose the cause of weighing errors exceeding the maximum permissible values.

AUTOTEST facilitates regular optimisation of balance settings which is necessary in order to maintain the best possible repeatability and weighing time at the workstation. The function allows you to monitor the parameters at optional moment and save records from carried out tests.

There are two modules:

AUTOTEST FILTER; AUTOTEST GLP.

Prior each test the balance controls level status, temperature and humidity.



AUTOTEST FILTER

Procedure consisting in loading and unloading of the internal weight for all possible 'filter' and 'value release' settings, the test requires 10 repetitions. It controls 2 parameters: 'Repeatability' and 'Stabilization time'.

The test takes approximately 1 hour. Upon completion, information regarding results is obtained.

Optimum settings for particular ambient conditions are provided.

Autotest Filter enables: to obtain the highest measurement repeatability and the

shortest measurement time with acceptable value of repeatability;
 test results are stored in balance memory until it is turned off,
 test results printout,
 direct and fast selection of optimal parameters.

Upon completed autotest, a summary with results is displayed.
 Information regarding filters settings is provided automatically via display of respective pictograms:



- settings providing the fastest measurement (the shortest measurement time).



- settings providing the most accurate measurement (the lowest possible value of deviation for 10 measurements).



- settings providing optimal measurement (the lowest value of time and deviation product).



- current settings for filters.

Measurement results:

- *Filter type.
- *<Value release> parameter value.
- *Repeatability of indications expressed as standard deviation.
- *Average time of measurement stabilization.

Example:

| Autotest Filter | | |
|-----------------|-----------------------------|---------------------|
| 3 | Very fast Reliable | 0.0010 g 3.650 s |
| 4 | Fast Fast | 0.0005 g 1.536 s |
| 5 | Fast Fast and reliable | 0.0005 g 2.038 s |
| 6 | Fast Reliable | 0.0004 g 3.181 s |
| 7 | Normal Fast | 0.0005 g 2.393 s |
| 8 | Normal Fast and reliable | 0.0011 g 2.881 s |
| 9 | Normal Reliable | 0.0005 g 4.073 s |

You can quickly modify 'filter' and 'value release' settings. To do that, select results for particular settings that are to be saved. Press <Activate>.

| Autotest Filter | | |
|-----------------|--------------------|----------|
| 1 | Filter | Fast |
| 2 | Value release | Fast |
| 3 | Repeatability | 0.0005 g |
| 4 | Stabilization time | 1.536 s |
| 5 | Enable | |

Report example:

----- Autotest Filter: Report -----

Balance type XA 4Y
Balance S/N 442566
Operator Hubert
Software ver. NL1.6.5 S
Date 2015.05.07
Time 09:34:48

Reading unit 0.0001/0.0001 g
Internal weight mass 148.9390 g
Temperature: Start 25.26 °C
Temperature: Stop 25.66 °C

Filter Very fast
Value release Fast
Repeatability 0.0042 g
Stabilization time 4.505 s

.
. .
. .

Filter Very slow
Value release Reliable
Repeatability 0.0207 g
Stabilization time 5.015 s

Signature

.....

Procedure:

Upon 'Autotest Filter' function activation, the process starts automatically. Progress bar is displayed. Upon process completion, a summary is displayed, current filter settings are provided. The report can be printed.

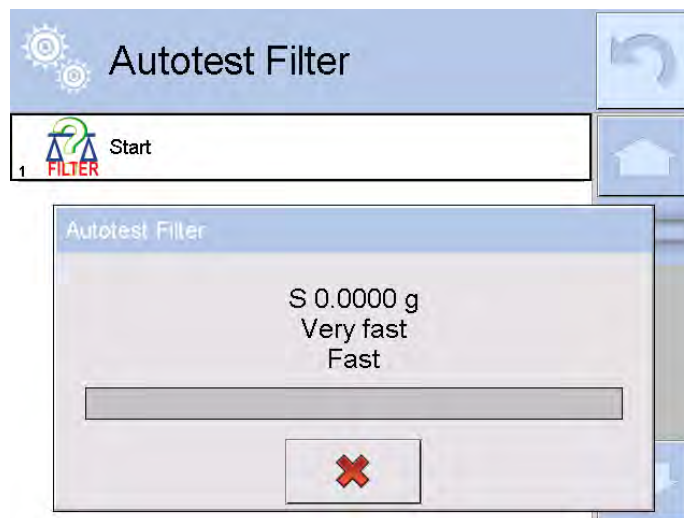

You can abort the process at any moment. To do that press <X> button.



AUTOTEST GLP

The test controls repeatability of loading the internal weight and determining error of indication with reference to module's maximum capacity.

Procedure:

- Two times loading of the internal weight, followed by 10 times loading of the internal weight.
- Adjust the weighing instrument,
- Calculating and recording the value of standard deviation.
- In weighing instrument with automatically opened doors, door opening and closing test is carried out.

Autotest GLP function enables:

Report display and printout,

Record of a report containing basic balance data, ambient conditions values and test results.

Test results:

- *Deviation for maximum capacity.
- *Value of repeatability expressed as standard deviation
- *Door test result (positive / negative).

Report example:

.....
Autotest GLP Report -----

Balance type *XA 4Y*

Balance S/N *400010*

Operator *Admin*

Software ver. *L0.0.21 S*

Date *2012.01.16*

Time *09:17:16*

Measurements quantity *10*

Reading unit *0.0001 g*

Internal weight mass *140.094 g*

Filter *Average*

Value release *Fast and rel.*

Deviation for Max. *-0.0118 g*

Repeatability *0.00088 g*

Signature

.....

Procedure:

Press entry with test name, a message box is displayed.

You can:

- Start subsequent AUTOTEST GLP process,
- Preview results of completed autotests, and export all saved test results as file with *.csv extension,
- Delete all saved test results.

You can abort the process at any moment by pressing <X> button.

Results of carried out autotests are displayed in a table (each line features date and time of autotest procedure and its result).

To preview particular autotest data, press respective table line.

In order to print a result of a single autotest, enter its details (see above) and generate a printout by pressing <Print> key located on the top of the display. Autotest results can be exported by pressing <Export> entry in the window with all saved reports. Data is sent to a USB flash drive connected to balance USB port as a file with *.csv extension.

22.13. Start-Up Logo

(option enabled only for authorized mass comparator operators)

The parameter enables you to change logo that is displayed on balance start-up.

22.14. Export of System Events

(option enabled only for authorized mass comparator operators)

The parameter enables you to generate a special type of a file that is automatically saved to a USB flash drive, plugged to USB port. The file helps RADWAG service to diagnose cause of problems occurring during balance operation.

Procedure:

- Plug a USB flash drive to mass comparator's USB port.
- Enter <  Misc.> submenu.
- Select <Export system events> parameter.
- The software generates a file and automatically saves it on the USB flash drive.
- The generated file has to be sent to RADWAG.

23. UPDATE

Update function enables update of:

- Help files available from the operator level.
- APPLICATION.
- Metrological parameters: main board (administrator exclusively).

Update takes place automatically by loading data from a USB flash drive connected to balance USB port.

Procedure:

- Prepare a USB flash drive with update file. Required file extension: *.lab2.
- Connect the USB flash drive to balance USB port.
- Select <Application> entry.
- The display previews content of the USB flash drive, search for the update file and press its name.
- Updating proceeds automatically.

Update of help files and the main board file is analogous; required files extensions are: *.hlp - help, *.mbu – main board.

24. ABOUT

'About' menu provides information on balance and balance program. Most of parameters in this menu are for the information purpose only.

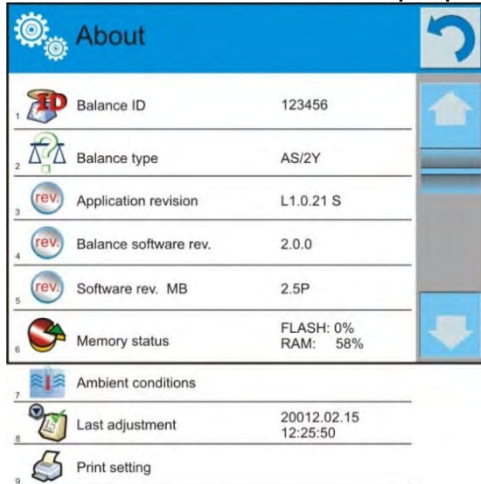

<Ambient conditions> parameter enables preview of present ambient conditions: temperature, humidity, pressure (if the balance features ambient conditions sensors).

<Print settings> parameter enables you to send all parameters to printer port.

25. VIDEOS

Videos menu enables display of instruction videos (*.wmv) presenting how to operate the balance. Administrator can add/delete videos. Remaining operators may only watch the videos stored in the balance memory.

To add a video you have to:

| Item | Value |
|------|---------------------|
| 1 | __aktualne |
| 2 | __czestotliwosciowa |
| 3 | __FILMY |
| 4 | 02_10_2013_ktp_e2r |
| 5 | 03_10_2012 |
| 6 | 04_03_2013_188_new |

- Save the video on a USB flash drive.
- Plug the drive to the USB port.
- Enter <Videos> menu.
- Press <+> button.
- Select respective file.
- The video is saved to the balance memory.

To play the video you have to:

- Save the video to the balance memory (see instruction above).
- Enter <Videos> menu.
- Press the name of a video to be played.

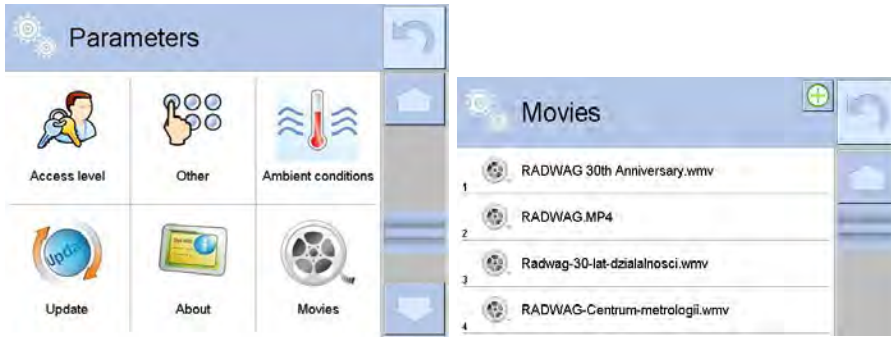

The video starts automatically.
Navigation buttons:

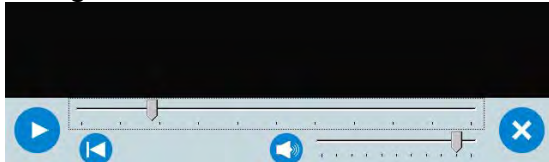

| | |
|--|--|
| | Play/ Pause playing |
| | Stop playing |
| | Increase/decrease the volume (volume power adjusted, for settings go to <Misc.> menu). |
| | Enabling/Disabling the volume |
| | Restart video |

26. COMMUNICATION PROTOCOL

General Information

- A. A character based communication protocol (balance-indicator) is designed for establishing communication between a RADWAG balance and a peripheral device via RS-232C interface.
- B. The protocol consists of commands sent from a peripheral device to the weighing instrument and responses from the weighing instrument.
- C. Responses are sent from the weighing instrument each time a command is received.
- D. Commands, forming the communication protocol, enable obtaining data on weighing device status and facilitate influencing weighing device operation, e.g.: acquiring measurement results from the weighing device, zeroing, etc.

26.1. List of Commands

| Command | Command overview |
|------------|--|
| Z | Zeroing |
| T | Taring |
| OT | Give tare value |
| UT | Set tare |
| S | Send stable measurement result in basic measuring unit |
| SI | Immediately send measurement result in basic measuring unit |
| SIA | Immediately give results from all platforms in basic measuring units |

| | |
|-----------------|---|
| SU | Send stable measurement result in current measuring unit |
| SUI | Immediately send measurement result in current measuring unit |
| C1 | Switch on continuous transmission in basic measuring unit |
| C0 | Switch off continuous transmission in basic measuring unit |
| CU1 | Switch on continuous transmission in current measuring unit |
| CU0 | Switch off continuous transmission in current measuring unit |
| DH | Set min checkweighing threshold |
| UH | Set max checkweighing threshold |
| ODH | Give value of min checkweighing threshold |
| OUH | Give value of max checkweighing threshold |
| SM | Set mass value of a single item |
| TV | Set target mass value |
| RM | Set reference mass value |
| NB | Give balance serial number |
| PROFILES | Set balance profile |
| PRG | Give set profile name |
| LOGIN | Operator logging |
| LOGOUT | Operator logout |
| SS | Value release |
| IC | Internal adjustment performance |
| IC1 | Disable automatic internal adjustment of the balance |
| IC0 | Enable automatic internal adjustment of the balance |
| K1 | Lock balance keypad |
| K0 | Unlock balance keypad |
| BP | Activate sound signal |
| OMI | Give available working modes |
| OMS | Set working mode |
| OMG | Give current working mode |
| PC | Send all implemented commands |
| BN | Give balance type |
| FS | Give max capacity |
| RV | Give program version |
| A | Set AUTOZERO function |
| EV | Set ambient conditions state |
| EVG | Give set ambient conditions state |
| FIS | Set filter |
| FIG | Give current filter setting |
| ARS | Set value release |

| | |
|------------|---|
| ARG | Give current value release setting |
| LDS | Set last digit |
| UI | Give accessible units |
| US | Set unit |
| UG | Give current unit |
| NT | Compatibility with PUE 7.1, PUE 10 indicators |

CAUTION:

Each command must end with CR LF characters.

26.2. Response Format

On receipt of a command, the indicator responds as follows:

| | |
|---------------|--|
| XX_A CR LF | command understood and in progress |
| XX_D CR LF | command carried out (appears only after the XX_A command) |
| XX_I CR LF | command understood but not accessible at this moment |
| XX _ ^ CR LF | command understood but max threshold is exceeded |
| XX _ v CR LF | command understood but min threshold is exceeded |
| XX _ OK CR LF | command carried out |
| ES_CR LF | command not recognised |
| XX _ E CR LF | time limit exceeded while waiting for stable measurement result (time limit is a characteristic balance parameter) |

XX - stands for a name of a sent command

_ - space

COMMANDS OVERVIEW

Press to zero the balance

Format: **Z CR LF**

Response options:

- Z_A CR LF - command understood and in progress
- Z_D CR LF - command carried out
- Z_A CR LF - command understood and in progress
- Z_^ CR LF - command understood but zeroing range is exceeded
- Z_A CR LF - command understood and in progress
- Z_E CR LF - time limit exceeded while waiting for stable measurement result
- Z_I CR LF - command understood but not accessible at this moment

Taring

Format: **T CR LF**

Response options:

- T_A CR LF - command understood and in progress
- T_D CR LF - command carried out
- T_A CR LF - command understood and in progress
- T_v CR LF - command understood but taring range is exceeded
- T_A CR LF - command understood and in progress
- T_E CR LF - time limit exceeded while waiting for stable measurement result
- T_I CR LF - command understood but not accessible at this moment

Give tare value

Format: **OT CR LF**

Response: **OT_TARE CR LF** - command carried out

Response format:

| | | | | | | | | | | |
|---|---|-------|------|-------|------|----|-------|----|----|----|
| 1 | 2 | 3 | 4-12 | 13 | 14 | 15 | 16 | 17 | 18 | 19 |
| O | T | space | tare | space | unit | | space | CR | LF | |

Tare - 9 characters, right justification

Unit - 3 characters, left justification

CAUTION:

Tare value is always given in adjustment unit.

Set tare

Format: **UT_TARE CR LF**, where **TARE** - tare value

Response options:

- UT_OK CR LF - command carried out
- UT_I CR LF - command understood but not accessible at this moment
- ES CR LF - command not recognised (tare format incorrect)

CAUTION:

Use dot in tare format as decimal point.

Send stable measurement result in basic measuring unit

Format: **S CR LF**

Response options:

- S_A CR LF - command understood and in progress
- S_E CR LF - time limit exceeded while waiting for stable measurement result
- S_I CR LF - command understood but not accessible at this moment
- MASS FRAME - command carried out, immediate response: mass value in basic measuring unit

Response format:

| | | | | | | | | | | | |
|---|-------|------------------|-------|-----------|------|-------|------|----|----|----|----|
| 1 | 2-3 | 4 | 5 | 6 | 7-15 | 16 | 17 | 18 | 19 | 20 | 21 |
| S | space | character marker | space | character | mass | space | unit | | CR | LF | |

Example:

S CR LF - command sent from a computer

S_A CR LF - command understood and in progress

S _ _ _ _ - _ _ _ _ _ 8 . 5 _ g _ _ CR LF - command carried out, immediate response:
mass value in basic measuring unit

where: _ - space

Immediately send measurement result in basic measuring unit

Format: **SI CR LF**

Response options:

SI_I CR LF - command understood but not accessible at this moment

MASS FRAME - command carried out, immediate response: mass value in basic measuring unit

Response format:

| | | | | | | | | | | | | |
|---|---|-------|------------------|-------|-----------|------|-------|------|----|----|----|----|
| 1 | 2 | 3 | 4 | 5 | 6 | 7-15 | 16 | 17 | 18 | 19 | 20 | 21 |
| S | I | space | stability marker | space | character | mass | space | unit | | | CR | LF |

Example:

S I CR LF - command sent from a computer

S I _ ? _ _ _ _ _ 1 8 . 5 _ k g _ CR LF - command carried out, immediate response:
mass value in basic measuring unit

where: _ - space

Send stable measurement result in current measuring unit

Format: **SU CR LF**

Response options:

SU_A CR LF - command understood and in progress

SU_E CR LF - time limit exceeded while waiting for stable measurement result

SU_I CR LF - command understood but not accessible at this moment

MASS FRAME - command carried out, immediate response: mass value in basic measuring unit

Response format:

| | | | | | | | | | | | | |
|---|---|-------|------------------|-------|-----------|------|-------|------|----|----|----|----|
| 1 | 2 | 3 | 4 | 5 | 6 | 7-15 | 16 | 17 | 18 | 19 | 20 | 21 |
| S | U | space | stability marker | space | character | mass | space | unit | | | CR | LF |

Example:

S U CR LF - command sent from a computer

S U _ A CR LF - command understood and in progress

S U _ _ _ - _ _ 1 7 2 . 1 3 5 _ N _ _ CR LF - command carried out, immediate response:
mass value in current measuring unit.

where: _ - space

Immediately send measurement result in current measuring unit

Format: **SUI CR LF**

Response options:

SUI_I CR LF - command understood but not accessible at this moment

MASS FRAME - command carried out, immediate response: mass value in basic measuring unit

Response format:

| | | | | | | | | | | | | |
|---|---|---|---------------------|-------|-----------|------|-------|------|----|----|----|----|
| 1 | 2 | 3 | 4 | 5 | 6 | 7-15 | 16 | 17 | 18 | 19 | 20 | 21 |
| S | U | I | stability marker | space | character | mass | space | unit | | | CR | LF |

Example:

S U I C R L F - command sent from a computer

S U I ? _ - _ _ _ 5 8 . 2 3 7 _ k g _ C R L F - command carried out, immediate response:
mass value in basic measuring unit

where: _ - space

Switch on continuous transmission in basic measuring unit

Format: **C1 C R L F**

Response options:

C1_I C R L F - command understood but not accessible at this moment

C1_A C R L F - command understood and in progress

MASS FRAME - command carried out, immediate response: mass value in basic measuring unit

Response format:

| | | | | | | | | | | | | |
|---|---|-------|---------------------|-------|-----------|------|-------|------|----|----|----|----|
| 1 | 2 | 3 | 4 | 5 | 6 | 7-15 | 16 | 17 | 18 | 19 | 20 | 21 |
| S | I | space | stability marker | space | character | mass | space | unit | | | CR | LF |

Switch off continuous transmission in basic measuring unit

Format: **C0 C R L F**

Response options:

C0_I C R L F - command understood but not accessible at this moment

C0_A C R L F - command understood and carried out

Switch on continuous transmission in current measuring unit

Format: **CU1 C R L F**

Response options:

CU1_I C R L F - command understood but not accessible at this moment

CU1_A C R L F - command understood and in progress

MASS FRAME - immediate response: mass value in current measuring unit

Response format:

| | | | | | | | | | | | | |
|---|---|---|---------------------|-------|-----------|------|-------|------|----|----|----|----|
| 1 | 2 | 3 | 4 | 5 | 6 | 7-15 | 16 | 17 | 18 | 19 | 20 | 21 |
| S | U | I | stability marker | space | character | mass | space | unit | | | CR | LF |

Switch off continuous transmission in current measuring unit

Format: **CU0 C R L F**

Response options:

CU0_I C R L F - command understood but not accessible at this moment

CU0_A C R L F - command understood and carried out

Set min checkweighing threshold

Format: **DH_XXXXX C R L F**, where: _ - space, **XXXXX** - mass format

Response options:

DH_OK CR LF - command carried out
 ES CR LF - command not recognised (mass format incorrect)

Set max checkweighing threshold

Format: **UH_XXXXX CR LF**, where: _ - space, **XXXXX** - mass format

Response options:

UH_OK CR LF - command carried out
 ES CR LF - command not recognised (mass format incorrect)

Give value of min checkweighing threshold

Format: **ODH CR LF**

Response: **DH_MASS CR LF** - command carried out

Response format:

| | | | | | | | | | | |
|---|---|-------|------|-------|------|----|-------|----|----|----|
| 1 | 2 | 3 | 4-12 | 13 | 14 | 15 | 16 | 17 | 18 | 19 |
| D | H | space | mass | space | unit | | space | CR | LF | |

Mass - 9 characters, right justification

Unit - 3 characters, left justification

Give value of max checkweighing threshold

Format: **OUH CR LF**

Response: **UH_MASS CR LF** - command carried out

Response format:

| | | | | | | | | | | |
|---|---|-------|------|-------|------|----|-------|----|----|----|
| 1 | 2 | 3 | 4-12 | 13 | 14 | 15 | 16 | 17 | 18 | 19 |
| U | H | space | mass | space | unit | | space | CR | LF | |

Mass - 9 characters, right justification

Unit - 3 characters, left justification

Set mass value of a single item (for PARTS COUNTING mode)

Format: **SM_XXXXX CR LF**, where: _ - space, **XXXXX** - mass format

Response options:

SM_OK CR LF - command carried out
 SM_I CR LF - command understood but not accessible at this moment (e.g. mode other than PARTS COUNTING)
 ES CR LF - command not recognised (mass format incorrect)

Set target mass value (e.g. DOSING mode)

Format: **TV_XXXXX CR LF**, where: _ - space, **XXXXX** - mass format

Response options:

TV_OK CR LF - command carried out
 TV_I CR LF - command understood but not accessible at this moment (e.g. mode other than DOSING)
 ES CR LF - command not recognised (mass format incorrect)

Set reference mass value (e.g. for PERCENT WEIGHING)

Format: **RM_XXXXX CR LF**, where: _ - space, **XXXXX** - mass format

Response options:

RM_OK CR LF - command carried out
 RM_I CR LF - command understood but not accessible at this moment (e.g. mode other

than PERCENT WEIGHING)

ES CR LF - command not recognised (mass format incorrect)

Value release

Format: **SS CR LF**

Response options:

SS_OK CR LF - command understood and in progress

Command's function is similar to function of PRINT key located on the instrument panel.

Internal adjustment

Format: **IC CR LF**

Response options:

IC_A CR LF - command understood and in progress

IC_D CR LF - adjustment completed

IC_A CR LF - command understood and in progress

IC_E CR LF - time limit exceeded while waiting for a stable measurement result

IC_I CR LF - command understood but not accessible at this moment

Disable automatic internal adjustment of the balance

Format: **IC1 CR LF**

Response options:

IC1_I CR LF - command understood but not accessible at this moment

IC1_E CR LF - operation disabled, e.g. for verified balance

IC1_OK CR LF - command carried out

Operation not possible for verified modules.

For non-verified balances the command disables internal adjustment until it is enabled via IC0 command or until the balance is turned off. The command does not modify settings specifying adjustment start.

Enable automatic internal adjustment of the balance

Format: **IC0 CR LF**

Response options:

IC0_I CR LF - command understood but not accessible at this moment

IC0_OK CR LF - command carried out

Operation not possible for verified modules.

Give balance serial number

Format: **NB CR LF**

Response options:

NB_A_"x" CR LF - command understood, response: serial number

NB_I CR LF - command understood but not accessible at this moment

x - balance serial number (in between inverted commas)

Example:

command: NB CR LF - give serial number

Response: NB_A_"1234567" - module serial number - "1234567"

Lock balance keypad

Format: **K1 CR LF**

Response options:

K1_I CR LF - command understood but not accessible at this moment

K1_OK CR LF - command carried out

Command locks the balance keypad (proximity sensors, touch screen) until the moment of turning the balance off or until sending K0 command.

Unlock balance keypad

Format: **K0 CR LF**

Response options:

K0_I CR LF - command understood but not accessible at this moment

K0_OK CR LF - command carried out

Give available working modes

Command overview:

Command returns accessible working modes.

Format: **OMI <CR><LF>**

Response options:

OMI <CR><LF>

n_ "Mode name" <CR><LF>

: - command carried out, response: accessible working modes

n_ "Mode name" <CR><LF>

OK <CR><LF>

OMI_I <CR><LF> - command understood but not accessible at this moment

Mode name – parameter, working mode name, inserted in between inverted comas. The name takes form given on a particular balance display, it is provided in a currently selected language.

n - parameter, decimal value determining working mode number.

n → 1 – Weighing

Caution:

Working modes numbering is identical for each kind of balance or scale. The numbers are assigned to working modes names.

Some balances give only the number as a response.

Example 1:

command: OMI <CR><LF> - return accessible working modes

Response: OMI <CR><LF>
1_ "Checkweighing" <CR><LF> - return accessible working modes,
mode number + name

OK <CR><LF> - command carried out

Set working mode

Command overview:

Command sets particular working mode.

Format: **OMS_n <CR><LF>**

Response options:

OMS_OK <CR><LF> - command carried out

OMS_E <CR><LF> - error in-course of command execution, no parameter
or incorrect format

OMS_E <CR><LF> - command understood but not accessible at this
moment

n - decimal value determining working mode number. To see detailed description go to OMI command.

Example:

command: OMS_1<CR><LF> - set WEIGHING mode

Response: OMS_OK<CR><LF> - set WEIGHING

Give current working mode

Command overview:

Command returns accessible working modes.

Format: **OMG<CR><LF>**

Response options:

OMG_n_OK <CR><LF> - command carried out, response: current working mode

OMG_I <CR><LF> - command understood but not accessible at this moment

n - decimal value determining working mode number. To see detailed description go to OMI command.

Example:

command: OMG<CR><LF> - return current working mode

Response: OMG_1_OK<CR><LF> - balance set to WEIGHING mode

Give accessible units

Command overview:

Command returns units available for a particular device and for a current working mode.

Format: **UI <CR><LF>**

Response options:

UI_”x₁,x₂, ... x_n”_OK<CR><LF> - command carried out, returns accessible units

UI_I <CR><LF> - command understood but not accessible at this moment

X - unit symbols, separated by means of commas.

x → g, mg, ct, lb, oz, ozt, dwt, tlh, tls, tlt, tlc, mom, gr, ti, N, baht, tola, u1, u2

Example:

command: UI <CR><LF> - return available units

Response: UI_”g, mg, ct”_OK<CR><LF> - response: available units

Set current unit

Command overview:

Command sets current unit for a particular device.

Format: **US_x <CR><LF>**

Response options:

US_x_OK <CR><LF> - command carried out, returns accessible units

US_E <CR><LF> - error in-course of command execution, no parameter or incorrect format

US_I <CR><LF> - command understood but not accessible at this moment

x - parameter, units symbols: g, mg, ct, lb, oz, ozt, dwt, tlh, tls, tlt, tlc, mom, gr, ti, N, baht, tola, msg, u1, u2, next.

Caution:

If x=next the command swaps to another available unit on the list (it simulates  button pressing).

Example:

command: US_mg<CR><LF> - set „mg” unit
Response: US_mg_OK<CR><LF> - „mg” set as a current unit

Give current unit

Command overview:

Command returns current unit.

Format: **UG<CR><LF>**

Response options:

UG_x_OK<CR><LF> - command carried out, returns accessible units

UG_I <CR><LF> - command understood but not accessible at this moment

x - parameter, units symbols

Example:

command: UG<CR><LF> - return current unit

Response: UG_ct_OK<CR><LF> - currently set unit is „ct”

Activate sound signal

Command overview:

Command activates BEEP sound signal for a specified amount of time.

Format: **BP_TIME<CR><LF>**

Response options:

BP_OK<CR><LF> - command carried out, BEEP activated

BP_E” <CR><LF> - no parameter or incorrect format

BP_I <CR><LF> - command understood but not accessible at this moment

TIME - parameter, decimal value specifying how long shall the sound last, parameter given in [ms]. Recommended range <50÷ 5000>.

If value greater than the permissible high limit is given, then BEEP sound is operated for the maximum permissible amount of time.

Example:

command: BP_350<CR><LF> - activate BEEP for 350 ms

Response: BP_OK<CR><LF> - BEEP activated

CAUTION:

BEEP sound activated via BP command is inhibited if in-course of its activation the sound is activated by means of other device: keypad, touch panel, proximity sensors.

Send all implemented commands

Format: **PC CR LF**

command: **PC CR LF** - send all implemented commands

Response: **PC_A_”Z,T,S,SI...”** - command carried out, the terminal displays all implemented commands.

Give balance type

Format: **BN <CR><LF>**

Response options:

BN_A_”x” <CR><LF> - command understood, response: module type

BN_I <CR><LF> - command understood but not accessible at this moment

x - balance series (inserted in between inverted commas), with general balance type in front.

Example:

command: BN <CR><LF> - return balance type
Response: BN_A "AS" - balance type XA 4Y

Give max capacity

Format: FS <CR><LF>

Response options:

FS_A "x" <CR><LF> - command understood, response: module max capacity
FS_I <CR><LF> - command understood but not accessible at this moment
x - Max value of reading units (in between inverted commas)

Example:

command: FS <CR><LF> - return Max capacity
- Max capacity: "220 g"
Response: FS_A "220.0000"

Give program version

Format: RV <CR><LF>

Response options:

RV_A "x" <CR><LF> - command understood, response: program version
RV_I <CR><LF> - command understood but not accessible at this moment
x - program version (in between inverted commas)

Example:

command: RV <CR><LF> - return program version
Response: RV_A " 1.1.1" - program version: "1.1.1"

Set AUTOZERO Function

Format: A_n <CR><LF>

Response options:

A_OK <CR><LF> - command carried out
A_E <CR><LF> - error in-course of command execution, no parameter or incorrect format
A_I <CR><LF> - command understood but not accessible at this moment
n - parameter, decimal value determining autozero settings.
n → 0 – autozero off
1 – autozero on

CAUTION:

Command changes settings for a current working mode.

Example:

command: A_1 <CR><LF> - turn autozero function on
Response: A_OK <CR><LF> - autozero function is on
AUTOZERO function operates until it is turned off by A 0 command.

Set ambient conditions state

Format: EV_n <CR><LF>

Response options:

EV_OK <CR><LF> - command carried out
EV_E <CR><LF> - error in-course of command execution, no parameter or incorrect format
EV_I <CR><LF> - command understood but not accessible at this moment

n - parameter, decimal value determining ambient conditions state

n → 0 – unstable ambient conditions

1 – stable ambient conditions

CAUTION:

Command changes settings for a current working mode.

Example:

command: EV_1<CR><LF> - set value 'stable' for ambient conditions option

Response: EV_OK<CR><LF> - set value 'stable' for ambient conditions option

<AMBIENT CONDITIONS> parameter is set to value <STABLE> until command EV 0 swaps it to value <UNSTABLE>.

Give set ambient conditions state

Command overview:

Command gives information about state of currently set ambient conditions.

Format: **EVG<CR><LF>**

Response options:

EVG_x_OK<CR><LF> - command carried out, response: set ambient conditions state

EVG_I <CR><LF> - command understood but not accessible at this moment

x - parameter, ambient conditions symbols

Example:

command: EVG<CR><LF> - give current ambient conditions state

Response: EVG_0_OK<CR><LF> - current ambient conditions state: unstable

Set filter

Format: **FIS_n <CR><LF>**

Response options:

FIS_OK <CR><LF> - command carried out

FIS_E <CR><LF> - error in-course of command execution, no parameter or incorrect format

FIS_I <CR><LF> - command understood but not accessible at this moment

n - parameter, decimal value determining filter number.

n → 1 – very fast

2 – fast

3 – average

4 – slow

5 – very slow

CAUTION:

The numbering is assigned to a particular filter name and it is identical for all balance types. The command changes settings for a current working mode if, for a particular balance type, filter settings are assigned to the working mode.

Example:

command: FIS_3<CR><LF> - set average filter

Response: FIS_OK<CR><LF> - average filter set

Give current filter setting

Command overview:

Command gives information about currently set filter.

Format: **FIG<CR><LF>**

Response options:

FIG_x_OK<CR><LF> - command carried out, response: currently set filter

FIG_I <CR><LF> - command understood but not accessible at this moment

x - parameter, symbol of currently set filter

Example:

command: FIG<CR><LF> - give current filter

Response: FIG_2_OK<CR><LF> - currently set filter: average

Set value release

Format: **ARS_n <CR><LF>**

Response options:

ARS_OK <CR><LF> - command carried out

ARS_E <CR><LF> - error in-course of command execution, no parameter or incorrect format

ARS_I <CR><LF> - command understood but not accessible at this moment

n - parameter, decimal value determining value release options

n → 1 – fast

2 – fast + reliable

3 – reliable

CAUTION:

The numbering is assigned to a particular value release option and it is identical for all balance types.

The command changes settings for a current working mode if, for a particular balance type, value release settings are assigned to the working mode.

Example:

command: ARS_2<CR><LF> - set value release parameter to fast+reliable option

Response: ARS_OK<CR><LF> - fast+reliable option set

Give current value release setting

Command overview:

Command gives information about current value release setting.

Format: **ARG<CR><LF>**

Response options:

ARG_x_OK<CR><LF> - command carried out, response: current value release setting

ARG_I <CR><LF> - command understood but not accessible at this moment

x - parameter, symbol of current value release setting

Example:

command: ARG<CR><LF> - give current value release setting

Response: ARG_2_OK<CR><LF> - current value release setting: fast+reliable

Set last digit

Format: **LDS_n <CR><LF>**

Response options:

LDS_OK <CR><LF> - command carried out

LDS_E <CR><LF> - error in-course of command execution, no parameter or incorrect format

LDS_I <CR><LF> - command understood but not accessible at this moment

n - parameter, decimal value determining last digit settings

n → 1 – always
 2 – never
 3 – when stable

CAUTION:

The numbering is assigned to a particular last digit option and it is identical for all balance types.

The command changes settings for a current working mode if, for a particular balance type, value release settings are assigned to the working mode.

Example:

command: LDS_1<CR><LF> - set last digit option to value 'always'

Response: LDS_OK<CR><LF> - 'always' value set

Operator logging

Format: **LOGIN_Name, Password CR LF**

Where: _ - space (enter name and password in a form provided by the balance – *lower-case letters and upper-case letters*).

Response options:

LOGIN OK CR LF - command understood, new operator logged in

LOGIN ERROR CR LF - command understood, an error in name or password occurred, log in failed

ES CR LF - command not recognized (error in format)

Operator logout

Format: **LOGOUT CR LF**

Response options:

LOGOUT OK CR LF - command understood, user is logged out

ES CR LF - command not recognized (error in format)

Give set profile name

Format: **PRG CR LF**

Response options:

PRG_A_ "x" CR LF - command understood, response: profile name

PRG_I CR LF - command understood but not accessible at this moment

x - profile name (in between inverted commas)

Example:

command: **PRG CR LF** - give profile name

Response: **PRG _A_ "Fast"** – profile name – "Fast"

Profile selection

Format: **PROFILE_Name CR LF**

Where: _ - space (enter name in a form provided by the balance – *lower-case letters and upper-case letters, spaces; e.g. Fast; Fast dosing, User, Precision*).

Response options:

PROFILE OK CR LF - command understood, new profile set

LOGIN ERROR CR LF - command understood, an error in name, profile setting impossible

ES CR LF - command not recognized (error in format)

Give accessible units

Command overview:

Command returns units available for a particular device and for a current working mode.

Format: **UI <CR><LF>**

Response options:

UI_”x₁,x₂, ... x_n”_OK<CR><LF> - command carried out, returns accessible units

UI_I <CR><LF> - command understood but not accessible at this moment

X - unit symbols, separated by means of commas

x → g, mg, ct, lb, oz, ozt, dwt, tlh, tls, tlt, tlc, mom, gr, ti, N, baht, tola, u1, u2

Example:

command: UI <CR><LF> - return available units

Response: UI_”g, mg, ct”_OK<CR><LF> - response: available units

Set current unit

Command overview:

Command sets current unit for a particular device.

Format: **US_x <CR><LF>**

Response options:

US_x_OK <CR><LF> - command carried out, returns accessible units

US_E <CR><LF> - error in-course of command execution, no parameter or incorrect format

US_I <CR><LF> - command understood but not accessible at this moment

x - parameter, units symbols: g, mg, ct, lb, oz, ozt, dwt, tlh, tls, tlt, tlc, mom, gr, ti, N, baht, tola, msg, u1, u2, next

Caution:

If x=next the command swaps to another available unit on the list (it simulates button pressing).

Example:

command: US_mg<CR><LF> - set „mg” unit

Response: US_mg_OK<CR><LF> - „mg” set as a current unit

Give current unit

Command overview:

Command returns current unit.

Format: **UG<CR><LF>**

Response options:

UG_x_OK<CR><LF> - command carried out, returns accessible units

UG_I <CR><LF> - command understood but not accessible at this moment

x - parameter, units symbols

Example:

command: UG<CR><LF> - return current unit

Response: UG_ct_OK<CR><LF> - currently set unit is „ct”

Compatibility with PUE 7.1, PUE 10 indicators

Format: **NT CR LF**

Response options:

ES CR LF - command not recognised (mass format incorrect)

MASS FRAME - command carried out, immediate response: mass value in basic measuring unit

Response format:

| | | | | | | | | | | | | | | | | | | |
|---|---|-------|------------------|-------------|--------------|--------------|-------|------|-------|-----------|-------|-------|-------|-----------|-------|------------------------|----|----|
| 1 | 2 | 3 | 4 | 5 | 6 | 7 | 8 | 9-18 | 19 | 20-22 | 23 | 24-32 | 33 | 34-36 | 37 | 38 | 39 | 40 |
| N | T | space | Stability marker | Zero marker | Range marker | Digit marker | space | Mass | space | Mass unit | space | tare | space | Tare unit | space | Hidden digits quantity | CR | LF |

NT - command

Stability marker - [space] if stable, [?] if unstable

Zero marker - [space] for any value but zero, [Z] for zero value

Range marker - marker informing on range within which mass value is comprised: [space] I-range balance, [2] II-range balance, [3] III-range balance

Digit marker - [zero] no digit, [1] one digit marker, [2] two digits marker, [3] three digits marker, [4] four digits marker, [5] five digits marker

Mass - 10 characters for net mass given in adjustment unit (with dot and a floating “-“ sign) with right justification

Mass unit - 3 characters, left justification

Tare - 9 characters with dot - right justification (when floating tare gets turned off automatically then zero value is sent)

Tare unit - 3 characters, left justification

Hidden digits quantity - Number specifying quantity of hidden digits: [space] when no digits are hidden, [1] when 1 digit is hidden

Example:

NT CR LF - command sent from a computer

N T _ ? _ _ 0 _ _ _ _ _ - 5 . 1 1 3 _ g _ _ _ _ _ 0 . 0 0 0 _ g _ _ _ 0 CR LF

- command carried out, response: mass value and remaining data

where: _ - space

26.3. Manual Printout / Automatic Printout

It is possible to generate printouts either manually or automatically.

- Manual printout: upon indication stabilization press  key.
- Automatic printout is generated automatically in accordance with the parameters set for automatic printout (read section: 16.7).

The content of printout depends on settings of <Standard printout> parameter - <Weighing printout template> (read: section: 15.5).

Mass printout format:

| 1 | 2 | 3 | 4 -12 | 13 | 14 | 15 | 16 | 17 | 18 |
|------------------|-------|-----------|-------|-------|------|----|----|----|----|
| stability marker | space | character | mass | space | unit | | | CR | LF |

Stability marker [space] if stable
[?] if unstable
[!] if air buoyancy compensation mode is enabled
[^] if high limit is out of range
[v] if low limit is out of range

Character [space] for positive values
[-] for negative values

Mass 9 characters with decimal point, right justification

Unit 3 characters, left justification

Example:

_____ **1 8 3 2 . 0 _ g _ _ CR LF** - a printout generated, with reference to <Weighing printout template> settings, from a weighing device upon pressing  key:

| | | | |
|---------------------------|-----------|----------------------------|------------|
| N (measurements quantity) | NO | Universal variable 1 ... 5 | NO |
| Date | NO | Net | NO |
| Time | NO | Tare | NO |
| Level status | NO | Gross | NO |
| Customer | NO | Current result | NO |
| Warehouse | NO | Additional unit | NO |
| Product | NO | Mass | YES |
| Packaging | NO | Non-standard printout | NO |

27. CONNECTING PERIPHERALS

The balance can be integrated with the following peripheral devices:

- computer,
- receipt printer: KAFKA, EPSON,
- PCL printer,
- additional display,
- barcode scanner,
- an optional peripheral device operating ASCII communication protocol.

28. ERROR MESSAGES



Max weighing threshold exceeded
Unload the weighing pan



Min weighing threshold exceeded
Install weighing pan



Zeroing out of range
Press tarring button or restart the balance



Display capacity out of range
Unload the weighing pan



Tarring out of range
Press zeroing button or restart the balance



Start mass out of range
Install weighing pan



Zeroing/tarring time out of range
Weighing indication unstable

-no level- Balance not levelled

-Err 100- Weighing module restart

In process In-course process resulting in unstable measurement (automatic feeder – pills feeding process or comparator – load change process)

29. ADDITIONAL EQUIPMENT

| Type | Name |
|--------|---|
| P0151 | RS232 cable for EPSON printer |
| EPSON | Dot matrix printer |
| | PCL printer |
| WD- xx | Additional display in plastic housing |
| CK-01 | Transponder card scanner |
| LS2208 | Barcode scanner |
| AP2-1 | Current loop unit |
| SAL | Anti-vibration bench for XA laboratory balances |
| | PC keyboard. |

30. APPENDIX A - Printout Variables

30.1. Variables List

CAUTION:

Each defined variable must be inserted in between curly bracket: {x}, where x – variable number.

List of variables defining non-standard printout templates and data displayed within the workspace:

| No. | Description |
|------|---|
| {0} | Standard printout in a calibration unit |
| {1} | Standard printout in a current unit |
| {2} | Date |
| {3} | Time |
| {4} | Date and time |
| {5} | Working mode |
| {6} | Net weight in a current unit |
| {7} | Net weight in adjustment unit |
| {8} | Gross weight in adjustment unit |
| {9} | Tare in adjustment unit |
| {10} | Current unit |
| {11} | Calibration unit |
| {12} | Min threshold |
| {13} | Max threshold |
| | |
| {26} | Result control |

| | |
|-------|---------------------------------------|
| {27} | Value |
| {28} | Level status |
| {30} | Gross value |
| {31} | Weighing platform no. |
| {32} | Serial number |
| {33} | Reading unit |
| {34} | Range |
| {35} | Parts counting: Reference sample mass |
| {36} | Percent weighing: Reference mass |
| | |
| {38} | Universal variable: Name |
| {39} | Universal variable: Value |
| | |
| {43} | Net weight in a supplementary unit |
| {44} | Additional unit |
| {45} | Target value |
| {46} | Tolerance |
| {47} | Difference |
| {48} | Balance type |
| | |
| {75} | Operator: Name |
| {76} | Operator: Code |
| {77} | Operator: Permissions |
| | |
| {80} | Packaging: Name |
| {81} | Packaging: Code |
| {82} | Packaging: Mass |
| {85} | Customer: Name |
| {86} | Customer: Code |
| {87} | Customer: TIN |
| {88} | Customer: Address |
| {89} | Customer: Postal code |
| {90} | Customer: City |
| {91} | Customer: Discount |
| {130} | Warehouse: Name |
| {131} | Warehouse: Code |
| {132} | Warehouse: Description |

| | |
|-------|--|
| | |
| {140} | Additional display: WD |
| {142} | Additional display: WWG |
| {143} | Hex |
| {144} | Hex UTF-8 |
| | |
| {146} | Gross weight value in current unit |
| {147} | Tare in current unit |
| | |
| {150} | Epson printer: Paper crop |
| {151} | PCL printer: Form feed |
| {155} | Cooperation with RADWAG CONNECT |
| | |
| {210} | Adjustment history: Adjustment type |
| {211} | Adjustment history: Nominal mass |
| {212} | Adjustment history: Current mass |
| {213} | Adjustment history: Difference |
| {214} | Adjustment history: Temperature |
| {215} | Adjustment history: Level status |
| {216} | Adjustment history: Weighing platform no. |
| {219} | Adjustment history: Date and time of the last adjustment |
| | |
| {440} | Minimum sample weight: Name |
| {441} | Minimum sample weight: Reference tare |
| {442} | Minimum sample weight |
| {443} | Minimum sample weight: Status |

30.2. Variables Formatting

You can format numerical variables, text variables and dates which are dedicated for printing, and which are displayed in the grey workspace of the display.

Formatting types:

- variables with left justification,
- variables with right justification,
- determining quantity of characters for printing / displaying,
- determining quantity of decimal places for numeric variables,
- converting the format of date and hour,
- converting numeric variables into EAN13 code,
- converting numeric variables and date into EAN128 code.

Special formatting characters:

| Character | Description | Example |
|-----------|--|--|
| , | Sign separating variable from format item. | {7,10} - Net weight in adjustment unit with constant length of 10 characters, with right justification |
| - | Minus sign or left justification | {7,-10} - Net mass in adjustment unit with constant length of 10 characters, with left justification |
| : | Sign proceeding formatting or time separator (i.e. hours, minutes and seconds) | {7:0.000} - Net mass in adjustment unit always with three decimal places; {3:hh:mm:ss} – Current time in format: hour : minute : second. |
| . | First detected dot in a digit is recognized as separator of integer and decimal parts. Each following dot is ignored. | {55:0.00} - Product's unit price always with two decimal places; {17:0.0000} – Measurements average, always with four decimal places; |
| F | Sign formatting digits to a chain of sign in format “-ddd.ddd...” (where: d - single digit, minus - for negative values only) or determination of decimal places quantity. | {7:F2} - Net mass in adjustment unit always with two decimal places; {7,9:F2} - Net mass in adjustment unit always with two decimal places and fixed length of 9 characters with right justification; |
| V | Formatting mass and quantities derivatives of mass in EAN13 code | {7:V6.3} - Net mass in a form of EAN13 code (6-character code) with three decimal places |
| T | Formatting mass and quantities derivatives of mass in EAN128 code | {7:T6.3} - Net mass in a form of EAN128 code with three decimal places; |
| / | Date separator separating days, months and years. | {2:yy/MM/dd} - Current date in format: year - month - day, where yy stand for two less meaningful characters of a year; |
| \ | Sign “escape” deleting a formatting function from the following sign, so that it is recognized as text | {2:yy\MM\dd} – Current date in format: year / month / day. {2:yy\MM\dd} - Current date in format: year : month : day. Should „\” be used in literal meaning, insert \; |

Formatted variables application:

| CODE | DESCRIPTION |
|-------------|---|
| {7:V6.3} | Net mass in EAN 13 code (6-character code) |
| {7:V7.3} | Net mass in EAN 13 code (7-character code) |
| {27:V6.3} | Net value in EAN 13 code (6-character code) |
| {27:V7.3} | Net value in EAN 13 code (7-character code) |
| {7:T6.3} | Net mass in EAN 128 code |
| {8:T6.3} | Gross mass in EAN 128 code |
| {55:T6.2} | Product price in EAN 128 code |
| {2:yyMMdd} | Date in EAN 128 code |
| {61:yyMMdd} | Product date in EAN 128 code |
| {62:yyMMdd} | Product expiry date in EAN 18 code |

31. APPENDIX B – Programmable Buttons List

| Pictogram | Name | Pictogram | Name |
|---|---------------------------|---|----------------------------|
|  | Profile selection |  | Right door opening/closing |
|  | Adjustment |  | Open / close door |
|  | Zeroing |  | Parameters |
|  | Taring |  | Products |
|  | Tare setting |  | Warehouses |
|  | Disable tare |  | Customers |
|  | Enable tare |  | Help |
|  | Packaging selection |  | Footer printout |
|  | Print |  | Units |
|  | Header printout |  | Edit universal variable 1 |
|  | Edit universal variable 2 |  | Accept |
|  | Edit universal variable 3 |  | Abort |
|  | Edit universal variable 4 |  | Working modes |
|  | Edit universal variable 5 |  | Operator |

32. APPENDIX E - Communication with Barcode Scanner

1. For communication with barcode scanners, RADWAG scales use RS232 interfaces and simplex transmission (one-way direction), without handshaking. For this purpose, use of second line of the cable is sufficient. Transmission parameters can be set for both weighing devices and scanners.
2. Transmission parameters can be set for both weighing devices and scanners. For both devices the following parameters must comply: baud rate, data bits quantity, parity control, stop bits quantity; e.g. 9600,8,N,1 – baud rate 9600 bit/s, data 8-bits, no parity control, 1 stop bit.
3. Barcode scanners can send additional information apart from the expected barcode; e.g. symbology (type of barcode). Due to the fact that RADWAG devices and software do not use such information, it is advisable to disable it.
4. Some RADWAG systems can omit unnecessary information by using parameters that mark the beginning and the length of the code required to analysis.
5. A special protocol is required in order the code be received by RADWAG equipment. It is required to program an appropriate *prefix* and *suffix*. In RADWAG-adopted standard, the prefix is 01 sign (byte) hexadecimal format, the suffix is 0D sign (byte) hexadecimal format.
6. Most barcode scanners allow to enable/disable different symbologies (barcode types).
7. Programming of scanners is performed by reading special barcodes.

| Barcode with required prefix and suffix in hexadecimal format | Barcode without required – fixes in ASCII format | Code type |
|---|--|-------------|
| 01 30 30 32 31 30 31 32 36 0D | 00210126 | EAN-8 |
| 01 30 31 32 33 34 35 36 37 38 39 0D | 0123456789 | CODE 2 OF 5 |
| 01 43 4F 44 45 20 33 39 20 54 45 53 54 0D | CODE 39 TEST | CODE 39 |
| 01 31 31 30 31 32 33 34 35 36 37 38 39 31 0D | 1101234567891 | EAN-13 |
| 01 43 6F 64 65 20 31 32 38 20 54 65 73 74 0D | CODE 128 Test | CODE 128 |

33. APPENDIX F – Menu Structure

User Adjustment

| Description | Value |
|---------------------------|----------|
| Internal adjustment | Function |
| External adjustment | Function |
| User adjustment | Function |
| Adjustment test | Function |
| Automatic adjustment time | 1 - 12 |

| | |
|--------------------|---|
| Report printout | No / Yes |
| Adjustment history | Displays a report on completed external adjustments |

Databases

- Weighing records
- Customers
- Susceptibility: reports
- Ambient conditions
- Warehouses
- Printouts
- Universal variables
- Delete data older than
- Export weighing database to a file

Communication

| Description | Value |
|-------------------|---------------|
| COM 1 | - |
| » Baud rate | 9600 |
| » Data bits | 8 |
| » Stop bits | 1 |
| » Parity | None |
| COM 2 | - |
| » Baud rate | 9600 |
| » Data bits | 8 |
| » Stop bits | 1 |
| » Parity | None |
| Ethernet | - |
| » DHCP | No |
| » IP Address | 192.168.0.2 |
| » Subnet mask | 255.255.255.0 |
| » Default gateway | 192.168.0.1 |
| TCP | - |
| Port | 4001 |

Peripherals

| Description | Value |
|-------------|-------|
| Computer | - |
| » Port | COM 1 |
| » Address | 1 |

| | | |
|----------------------------------|---------------------------|-------------------------------|
| | » Continuous transmission | No / Yes |
| | » Printout template | Option |
| | » E2R System | Option |
| Printer | | |
| | » Port | COM 2 |
| | » Code page | 1250 |
| | » Printouts | Option |
| Barcode scanner | | |
| | » Port | None / COM 1/ COM 2 |
| | » Offset | 0 |
| | » Length of code | 0 |
| Transponder card scanner | | |
| | Port | None / COM 1/ COM 2 |
| Additional display | | |
| | Port | None / COM 1-2 / Tcp |
| | Project | Option |
| Ambient conditions module | | |
| | Port | None / COM 1-2 / Com internal |
| | Address | 3 |

Inputs / Outputs

| Description | Value |
|----------------|--------|
| Inputs | |
| » Input 1 | Option |
| » Input 2 | Option |
| » Input 3 | Option |
| » Input 4 | Option |
| Outputs | |
| » Output 1 | Option |
| » Output 2 | Option |
| » Output 3 | Option |
| » Output 4 | Option |

Permissions

| Description | Value |
|------------------------|--|
| Anonymous operator | |
| » Guest | Option |
| » Operator | Option |
| » Advanced operator | Option |
| » Administrator | Option |
| Date and time | |
| » Guest | Option |
| » Operator | Option |
| » Advanced operator | Option |
| » Administrator | Option |
| Printouts | |
| » Guest | Option |
| » Operator | Option |
| » Advanced operator | Option |
| » Administrator | Option |
| Databases | |
| Products | Option: - Guest - Operator - Advanced operator - Administrator |
| Customers | |
| Formulations | |
| Packaging | |
| Warehouses | |
| Printouts | |
| Delete data older than | |

Misc.

| Description | Value |
|-------------------------|----------|
| Language | Option |
| Date and time | Option |
| Beep | Option |
| Touch panel calibration | Function |
| Level control | Option |
| Autotest | Option |

User manual number:
IMMU-99-01-08-18-EN



RADWAG BALANCES AND SCALES
ADVANCED WEIGHING TECHNOLOGIES

