

WEIGHING MODULES

MAS R
MPS R

USER MANUAL

IMMU-13-04-01-18-EN



Congratulations and thank you for selecting RADWAG product.
You have purchased a device that has been designed and manufactured to give you years of service.
Please read this User Manual carefully, this shall guarantee reliable operation.

JANUARY 2018

CONTENTS

1. GENERAL INFORMATION	6
1.1. Dimensions	6
1.2. Connectors Arrangement	7
2. GENERAL INFORMATION	7
2.1. Intended Use	7
2.2. Terms of Use	7
2.3. Warranty	9
2.4. Supervision Over Metrological Parameters	9
2.5. User Manual	9
2.6. Operator Training	9
3. TRANSPORT AND STORAGE	9
3.1. Delivery Check	9
3.2. Packaging	9
4. UNPACKING AND INSTALLATION	9
4.1. Place of Use	9
4.2. Unpacking	10
4.3. Standard Delivery Components List	10
4.4. Levelling	10
4.5. Maintenance Activities	11
4.6. Powering the Device	12
4.7. Connecting Peripheral Equipment	13
5. START-UP	13
5.1. Temperature Stabilization Time	13
6. COOPERATION WITH PERIPHERALS	14
Data Transmission Format	14
Format of data sent upon pressing print key	14
6.1.1. Format of Data Sent as a Response for Commands Generated from a Computer	15
7. COMMUNICATION PROTOCOL	16
7.1. List of Commands	16
7.2. Response Format	17
8. KEYPAD	29
8.1. Operator Menu	30
8.2. Log in Operation	31
8.3. Units	32
8.4. Temporary Weighing Unit Selection	32
8.5. Weighing Units Availability	32
8.6. Start Unit Selection	33
8.7. Custom Unit	33
9. MISCELLANEOUS	34
10. ADJUSTMENT	36
10.1. Internal adjustment	37
10.2. Adjustment Menu	37
10.3. Manual adjustment	38

10.3.1.	Internal Adjustment.....	38
10.3.2.	External adjustment	38
10.3.3.	User Adjustment	39
10.4.	Adjustment Report Printout	39
11.	PRINTOUTS CONTENT	40
11.1.	Adjustment Report	40
11.2.	Header, Footer, GLP Printouts	40
11.3.	Non-standard Printouts	42
11.3.1.	Inserting Texts.....	42
11.4.	Variables	44
12.	DATABASES	44
12.1.	Operators.....	44
12.2.	Products.....	46
12.3.	Tares	46
12.4.	Weighings	46
12.5.	ALIBI Memory.....	48
13.	WORKING MODES	49
13.1.	Working Modes Availability	50
13.2.	Weighing.....	50
13.2.1.	Good Weighing Practice.....	50
13.2.2.	Zeroing	51
13.2.3.	Taring.....	51
13.2.4.	Weighing Profiles.....	52
13.2.4.	<WEIGHING> Mode Settings - Readout	53
13.2.5.	AUTOTARE.....	55
13.2.6.	Print Mode.....	56
13.2.7.	Information	57
13.2.8.	Non-standard Information	58
13.2.9.	F Quick Access Keys	58
13.2.10.	Under-Pan Weighing	60
13.3.	Counting Parts of the Same Mass	60
13.3.1.	Parts Counting Settings.....	60
13.3.2.	Setting Reference Sample Mass Using Sample of Known Quantity	61
13.3.3.	Setting Reference Sample Mass by Entering Mass of a Single Part	62
13.4.	Checkweighing.....	62
13.4.1.	Declaring Checkweighing Thresholds.....	63
13.5.	Dosing	63
13.5.1.	Setting Target Mass by Entering its Value.....	64
13.6.	Percent Weighing Against Reference Sample Mass.....	65
13.6.1.	Setting Reference Sample Mass by Weighing	65
13.6.2.	Setting Reference Mass by Entering.....	65
13.7.	Animal Weighing	66
13.7.1.	Additional Settings for Animal Weighing	66
13.7.2.	Manual Weighing.....	67
13.7.3.	Automatic Weighing.....	68
13.8.	Solids Density	68
13.8.1.	Density Measurement	68
13.9.	Liquid Density	70
13.9.1.	Density Measurement	70
13.10.	Statistics.....	71
13.10.1.	Means of Operation.....	72

13.10.2. Deleting Statistics.....	73
13.11. Totalizing	74
13.11.1. Additional Settings for Totalizing	74
13.11.2. Means of Operation:	74
13.12. Peak Hold.....	75
13.12.1. Means of Operation.....	76
13.13. Basic Totalizing	76
13.13.1. Means of operation:	76
13.14. Pipettes Calibration	79
13.14.1. Additional Settings for Pipettes Calibration.....	79
13.14.2. Procedure:	80
14. COMMUNICATION	83
14.1. RS 232 (COM) Ports Settings	83
14.2. Wi-Fi Settings	83
14.3. USB Port	85
15. PERIPHERALS	87
15.1. Computer	87
15.1.1. Computer Port	87
15.1.2. Continuous Transmission.....	88
15.1.3. Interval for Printouts During Continuous Transmission	88
15.1.4. Cooperation with E2R.....	88
15.1.5. Printout.....	89
15.2. Printer	89
15.3. Barcode Scanner	91
15.4. Additional Display.....	92
16. ERROR MESSAGES.....	92
17. ADDITIONAL EQUIPMENT	92

1. GENERAL INFORMATION

1.1. Dimensions

MAS module

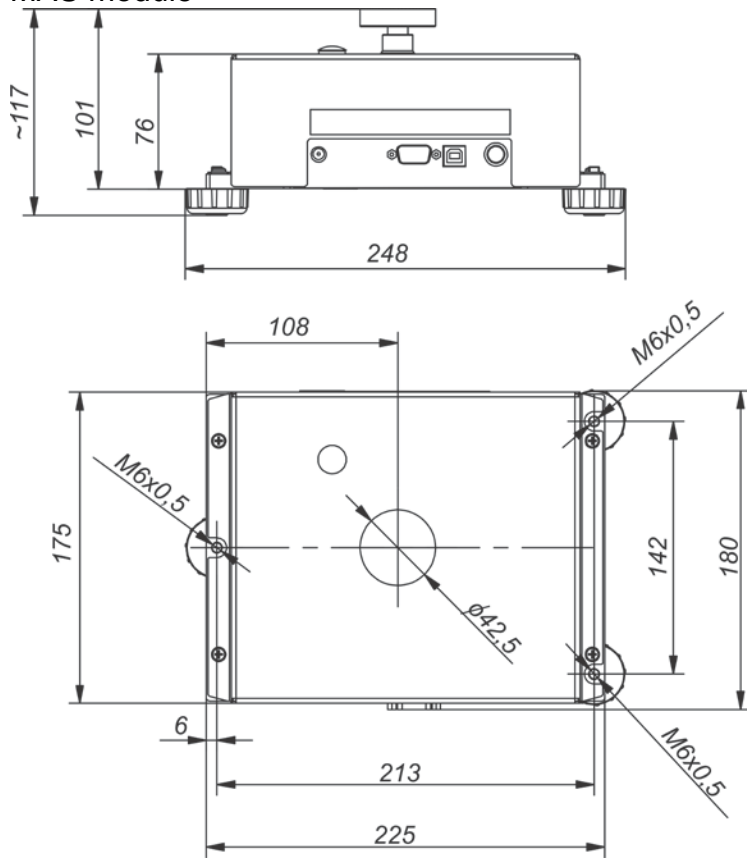

MPS module

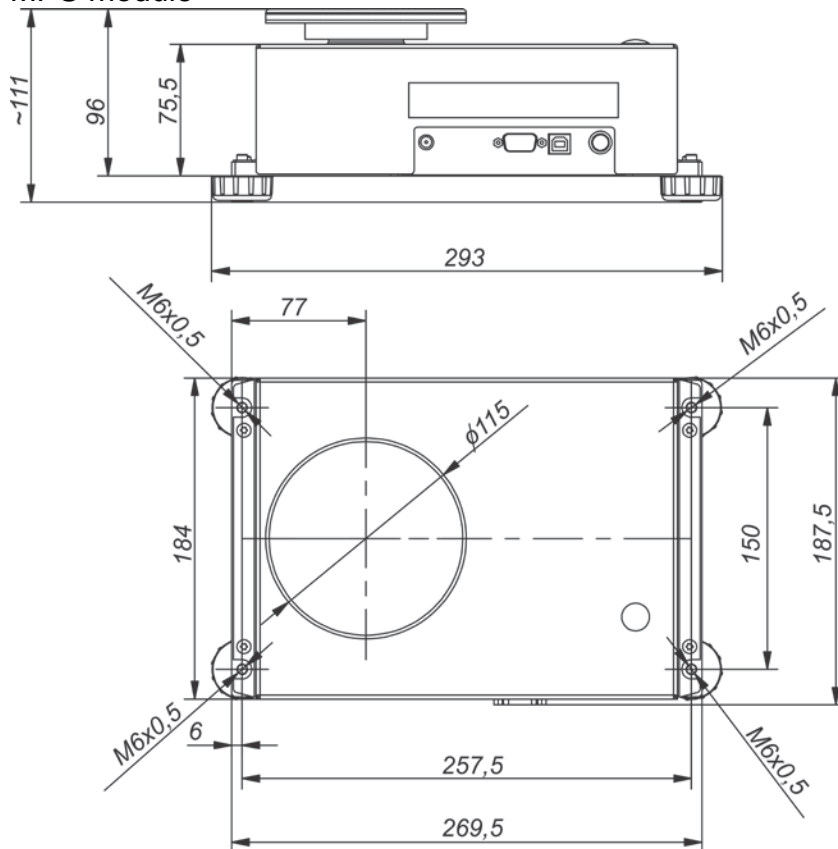

1.2. Connectors Arrangement

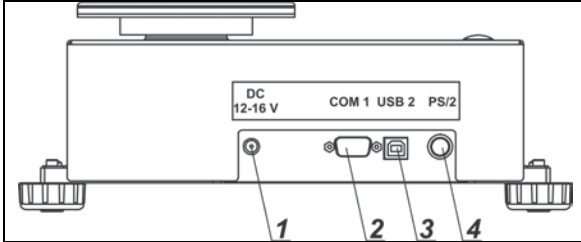
	1	- power supply seat
	2	- COM 1 connector (e.g. printer)
	3	- USB 2 connector (e.g. computer)
	4	- operator panel connector

2. GENERAL INFORMATION

2.1. Intended Use

MAS and MPS weighing modules are based on electromagnetic digital converter. The modules are intended for installation on technological lines or in laboratory equipment which require mass measurements of the accuracy not lower than 0.1 mg.

Communication with the module is carried out directly via RS 232 interface or optional operator panel.

Measurements can be carried out using weighing pan or under-pan weighing system – when the load is suspended beneath the module.

The modules feature internal adjustment, triggered by temperature change, and definable time interval as well as the weighing pan overload protection. They are also equipped with the following communication interfaces: 1 x RS 232, USB type B, PS/2.

Possible configurations:



2.2. Terms of Use

The module housing is made of aluminium and the weighing pan of stainless steel. It is possible to use a non-standard weighing pan and adjust it to the holding fixture (see the fixture dimensions in the figure below).

An example of weighing pan assembly for the MAS module:

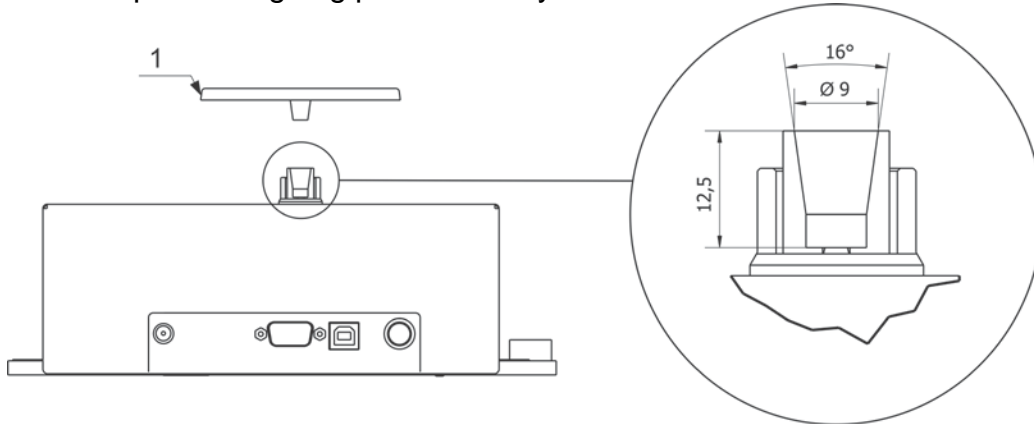

CAUTION: in order to avoid any problems, the used supplementary pan has to weigh about 103g (standard weighing pan, delivered with a weighing module, is 103g).

An example of weighing pan assembly for the MPS module:

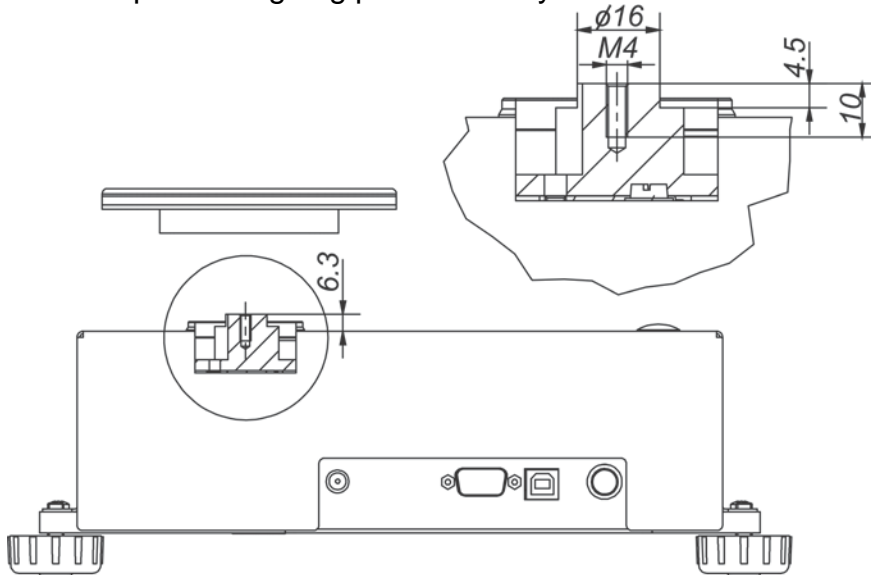

Due to the high measuring accuracy, it is recommended to install the module inside customer's instrument (e.g. in a draft shield) in order to reduce the influence of ambient conditions on the measurement result.

The module is not intended for dynamic weighing. Even if small amounts of a sample are added to or taken off the weighing pan, the mass readout should only be taken on stabilization of measurement result (upon displaying stability pictogram). Do not place magnetic materials on the weighing pan. This can damage the measuring system.

Be sure to avoid impact shock and overloading the weighing pan. Remember to include the tare (e.g. mass of a container loaded onto the weighing pan). The module is not designed to operate in hazardous areas.

2.3. Warranty

The warranty does not cover:

- product exploitation other than specified in user manual,
- product exploitation other than intended,
- carrying out product modifications,
- unauthorized opening of the instrument panel,
- mechanical defects or defects caused by liquids, water and natural wear,
- defects caused by inappropriate setting or by electrical wiring failures,
- overloading of the measuring mechanism.

2.4. Supervision Over Metrological Parameters

Metrological parameters need to be checked in determined time intervals. Inspection frequency depends on ambient conditions in which the weighing instrument is operated, kind of carried out processes and adopted quality management system.

2.5. User Manual

Even if you are experienced and have already worked with this type of weighing instrument, you are still obliged to read this user manual carefully prior switching the device on. This user manual provides necessary operation-related information. Following the user manual guidelines guarantees correct weighing instrument performance.

2.6. Operator Training

The weighing instrument must be utilized and supervised only by persons who have been trained to operate such type of a weighing instrument.

3. TRANSPORT AND STORAGE

3.1. Delivery Check

Upon delivery it is necessary to check the package and the device, make sure that your package bears no signs of damage. Otherwise contact the manufacturer's representative.

3.2. Packaging

Keep all package elements should your device be transported in the future. Remember that only original packaging can be used for shipping purposes. Prior packing, uncouple any cables, remove any separable components (weighing pan, shields, inserts). The device components shall be packed into an original packaging, thus being protected against potential damage during transportation.

4. UNPACKING AND INSTALLATION

4.1. Place of Use

- * Make sure that the ambient temperature ranges between: $+10\text{ °C} \div +40\text{ °C}$
- * Make sure that the relative humidity is not higher than 80%,
- * Slow temperature change in the course of operation,

- * Take special precaution while weighing magnetic objects, as part of the module is a strong magnet. Should such loads be weighed, use under-pan weighing option in order to remove the weighed load from an area influenced by the magnet. The hook for under-pan weighing is installed in the weighing instrument's base.
- * Ground the module's base should static electricity affect the weighing result.

4.2. Unpacking

Cut the adhesive tape. Take the device out of the packaging.
Open the accessory box, take the device components out of it.

4.3. Standard Delivery Components List

- Module
- Weighing pan
- Draft shield
- Power supply
- user manual - CD version

MAS module weighing pan assembly

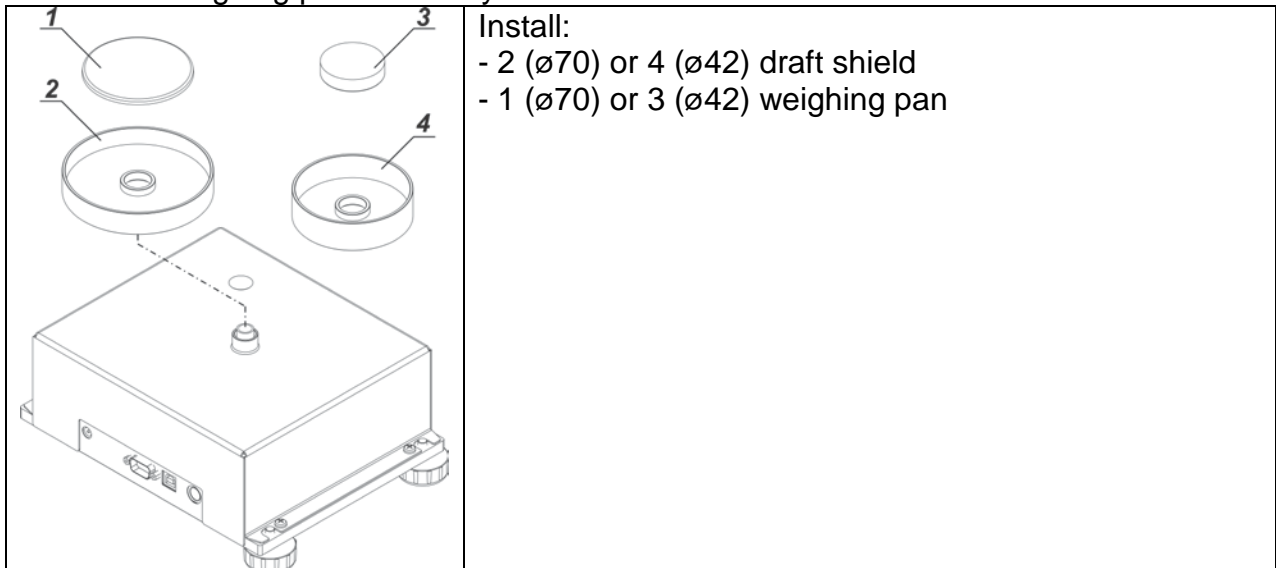

MPS module weighing pan assembly

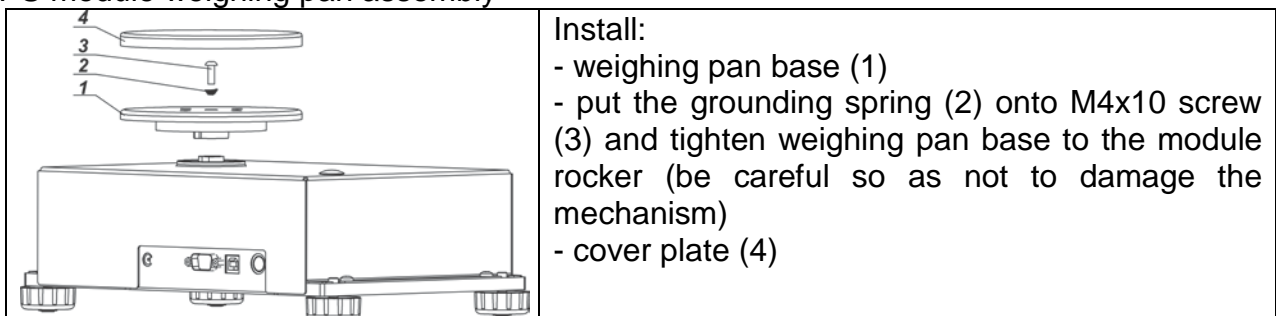

4.4. Levelling



It is necessary to level the module prior connecting it to the mains. To level the module turn its feet until the air bubble takes central position.

Make sure that all module feet rest on the worktop surface firmly.

4.5. Maintenance Activities

Maintenance activities:

1. Disassembly a weighing pan and other detachable components (the components differ depending on the weighing instrument model, read section: *UNPACKING AND INSTALLATION*). Be careful while detaching the components so as not to cause any damages to the module mechanism.
2. In order to ease cleaning of glass anti-draft chamber panes, it is permissible to remove them following the below instruction.

Caution:

Cleaning the weighing pan while still installed may cause damage of the measuring system.

Cleaning ABS Components:

To clean dry surfaces and avoid smudging, use clean non-colouring cloths made of cellulose or cotton. You can use a solution of water and detergent (soap, dishwashing detergent, glass cleaner). Gently rub the cleaned surface and let it dry. Repeat cleaning process if needed.

In the case of hard to remove contamination, e.g: residues of adhesive, rubber, resin, polyurethane foam etc., you can use a special cleaning agents based on a mixture of aliphatic hydrocarbons that do not dissolve plastics. Before using the cleanser for all surfaces we recommend carrying out tests. Do not use cleansers containing abrasive substances.

Cleaning anti-draft chamber panes:

Select dissolvent depending on a dirt. Never soak the glass panes in alkaline solutions since they interact with glass and may cause damage. Do not use cleansers containing abrasive substances.

For organic dirt use acetone first, next use water or detergent. For other than organic dirt use diluted acid solutions (soluble salts of hydrochloric or nitric acid) or base solutions (ammonium or sodium base).

To remove ACIDS use protophilic solvent (sodium carbonate), to remove BASE use protogenic solvent (mineral acid of various concentration).

In case of heavy contamination use brush or detergent nevertheless avoid detergents containing large and hard molecules which could potentially scratch glass panes.

At the end of the cleaning process rinse the pane using running water first, distilled next.

Use soft brush with wooden or plastic handle exclusively in order to avoid risk of scratches. Do not use wire brush.

Rinsing is a necessary cleaning process stage allowing to remove remaining soap, detergents and other cleansers from the panes prior their reinstallation.

At the end of the cleaning process rinse the pane using running water first, distilled next.

Avoid drying the panes either using paper towel or forced air circulation since some fibres, grains or contamination of other type could permeate into the panes thus causing weighing errors.

One shall not use driers when drying measuring glass tools.

It is a frequent treatment to leave glass components on a rack to dry.

Cleaning stainless steel components:

Avoid using cleansers containing any corrosive chemicals, e.g. bleach (containing chlorine). Do not use cleansers containing abrasive substances. Always remove the dirt using microfibre cloth to avoid damage of protective coating.

In case of a daily maintenance:

- 1. Remove the dirt using cloth dipped in warm water.*
- 2. For best results, add a little bit of dishwashing detergent.*

Cleaning powder-coated components:

For preliminary cleaning stage you need running water or wet sponge featuring large holes, this will help you to remove loose, heavy dirt.

Do not use cleansers containing abrasive substances.

Next, using cloth and cleanser-water solution (soap, dishwashing liquid) gently rub the cleaned surface.

Avoid using cleanser without water since it may result with damage of the cleaned surface, please mind that large amount of water mixed with cleanser is a must.

Cleaning aluminium components:

While cleaning aluminium components use products acid by nature, e.g. spirit vinegar, lemon. Do not use cleansers containing abrasive substances. Avoid using hard brush, this may cause scratches. It is recommended to use microfiber cloth.

While polishing the surface use circular movements. Use clean, dry cloth.

4.6. Powering the Device

The weighing instrument can be connected to the mains only with a power supply that comes standard with the particular model. Nominal voltage of the power supply (specified on the power supply data plate) has to be compatible with the power from the mains.

Plug the instrument to the mains – connect the power adapter to the socket, next plug its connector to interface located at the side of the instrument housing.

Upon plugging the instrument to the mains the software runs. During the module start, the test of an internal adjustment mechanism takes place (the internal adjustment weight is put down and lifted up).

4.7. Connecting Peripheral Equipment

The module must be unplugged from the mains before connecting or disconnecting any peripheral equipment (printer, PC computer).

Use only accessories and peripheral equipment recommended by the manufacturer.

Upon connecting the peripherals, plug the module to the mains.

5. START-UP

The basic version of the module is not equipped with a display. The measured mass of the load is directly sent to the computer connected to the module via RS232 connector. To configure the module use **operator panel**. Connect it to the PS2 port on the module housing (see figure below).

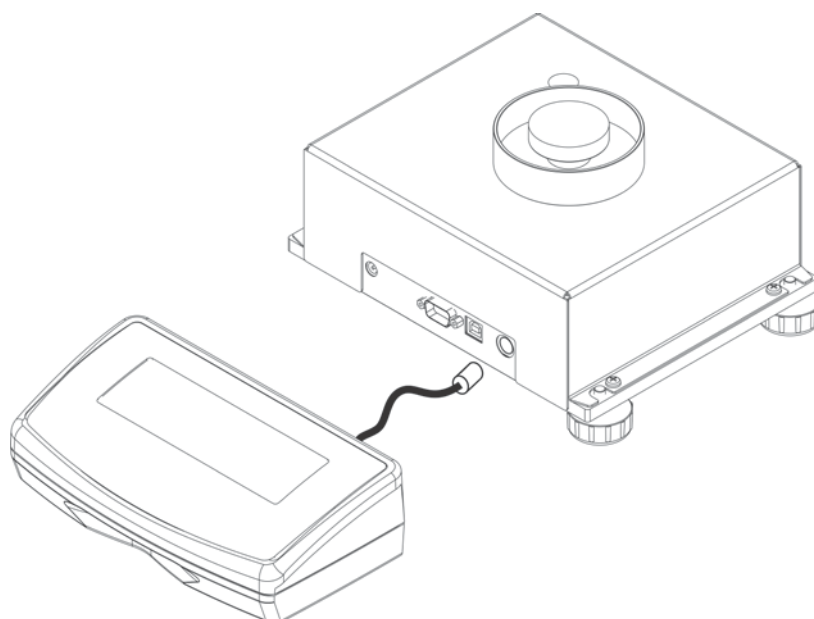

Upon connecting the panel, the module features all functions of R series balance which functions and settings are described further down this user manual.

Upon connecting to the mains, the name and number of the software are displayed and the instrument proceeds to the weighing function.

5.1. Temperature Stabilization Time

Before start of the measuring processes, it is necessary to wait until the module reaches thermal stabilization.

Modules stored in much lower temperatures, than the workroom temperature, before being plugged to the mains must be subjected to thermal stabilization. The thermal stabilization period takes about 4 hours in case of the MPS modules and about 8 hours in case of the MAS modules. Potential workroom temperature change shall occur gradually and slowly in the course of the weighing instrument operation.

6. COOPERATION WITH PERIPHERALS

Caution:



Peripheral device connected to RS 232 or USB port must be supplied with power from a common low voltage grid, with common protection against electric shocks, in a way preventing potential difference on neutral conductors of a module and a peripheral device.

Transmission parameters programmed in a module must accord with parameters of a device connected to the module.

- Baud rate - 4800 ÷ 115200 bit / s
- Parity control - NONE, ODD, EVEN

The module indication can be sent via RS232 or USB interface to a peripheral device as follows:

- Manually - upon pressing  key.
- Automatically - upon indication stabilization.
- Continuously - upon function activation or upon sending the control command.
- Upon a peripheral device request (read: additional functions).

The module indication can be sent via either COM or USB port as a value of the following kind:

- stable – information is sent upon indication stabilization,
- unstable - indication is sent to a peripheral device upon sending the command (unstable indication is marked with <?> symbol on a printout, the symbol is printed on the left of the weighing result).

Data Transmission Format

The weighing result can be sent from a module to a peripheral device by pressing  key, located on the operation panel, or by sending a control command from a computer.

Format of data sent upon pressing print key



Caution: For verified balances, printout of unstable weighing results is blocked.

Printout format for unverified balances:

1	2	3	4 - 12	13	14 - 16	17	18
stability marker	space	character	mass	space	unit	CR	LF

stability marker - [space] - if stable

- [?] - if unstable
- [^] - if high limit is out of range
- [v] - if low limit is out of range

character - [space] - for positive values or [-] for negative values

mass - 9 characters - right justification

unit - 3 characters - left justification.

Printout format for verified balances:

1	2	3	4 - 14	15	16 - 18	19	20
stability marker	space	character	mass	space	unit	CR	LF

stability marker - [space] - if stable
 - [?] - if unstable
 - [^] - if high limit is out of range
 - [v] - if low limit is out of range

character - [space] - for positive values or [-] for negative values

mass - 11 characters - right justification (contains decimal marks)

unit - 3 characters - left justification.

6.1.1. Format of Data Sent as a Response for Commands Generated from a Computer

Upon receipt of a command, the module responds as follows:

XX_A CR LF - command understood and in progress

XX_I CR LF - command understood but not accessible at this moment

XX_^ CR LF - command understood but max range is exceeded

XX_v CR LF - command understood but min range is exceeded

XX_E CR LF - time limit exceeded while waiting for stable measurement result (time limit is a characteristic balance parameter)

XX - command name.

next:

1 - 3	4	5	6	7	8 - 16	17	18 - 20	21	22
command	space	stability marker	space	character	mass	space	unit	CR	LF

command - 1 ÷ 3 - characters

stability marker - [space] - if stable
 - [?] - if unstable
 - [^] - if high limit is out of range
 - [v] - if low limit is out of range

character - [space] - for positive values or [-] for negative values

mass - 9 characters - right justification

unit - 3 characters - left justification.

7. COMMUNICATION PROTOCOL

General Information

- A character based communication protocol module-terminal is designed for establishing communication between a RADWAG module and a peripheral device.
- The protocol consists of commands sent from a peripheral device to the weighing instrument and responses from the weighing instrument.
- Responses are sent from the weighing instrument each time a command is received.
- Commands, forming the communication protocol, enable obtaining data on weighing device status and facilitate influencing weighing instrument operation, e.g.: acquiring measurement results from the weighing instrument, zeroing, etc.

7.1. List of Commands

Command	Command overview
Z	Zero balance
T	Tare balance
OT	Give tare value
UT	Set tare
S	Send stable measurement result in basic measuring unit
SI	Immediately send measurement result in basic measuring unit
SU	Send stable measurement result in current measuring unit
SUI	Immediately send measurement result in current measuring unit
C1	Switch on continuous transmission in basic measuring unit
C0	Switch off continuous transmission in basic measuring unit
CU1	Switch on continuous transmission in current measuring unit
CU0	Switch off continuous transmission in current measuring unit
DH	Set min checkweighing threshold
UH	Set max checkweighing threshold
ODH	Give value of min checkweighing threshold
OUH	Give value of max checkweighing threshold
SM	Set mass value of a single item
TV	Set target mass value
RM	Set reference mass value
NB	Give balance serial number
SS	Value release
IC	Internal adjustment performance
IC1	Disable automatic internal adjustment of the balance
IC0	Enable automatic internal adjustment of the balance
K1	Lock balance keypad
K0	Unlock balance keypad
OMI	Give available working modes
OMS	Set working mode
OMG	Give current working mode
UI	Give accessible units
US	Set unit

UG	Give current unit
BP	Activate sound signal
PC	Send all implemented commands
BN	Give balance type
FS	Give Max capacity
RV	Give program version
A	Set autozero function
EV	Set ambient conditions state
EVG	Give currently set ambient conditions
FIS	Set filter
FIG	Give current filter
ARS	Set value release
ARG	Give current value release
LDS	Set last digit
NT	Cooperation with PUE 7.1, PUE 10 terminal

Caution: Each command must end with CR LF characters.

7.2. Response Format

On receipt of a command, the terminal responds as follows:

XX_A CR LF	command understood and in progress
XX_D CR LF	command carried out (appears only after the XX_A command)
XX_I CR LF	command understood but not accessible at this moment
XX_ ^ CR LF	command understood but MAX threshold is exceeded
XX_ v CR LF	command understood but MIN threshold is exceeded
XX_ OK CR LF	command carried out
ES_CR LF	command not recognised
XX_ E CR LF	time limit exceeded while waiting for stable measurement result (time limit is a characteristic balance parameter)

XX - stands for a name of a sent command

_ - stands for spaces

Commands Overview

Zero balance

Format: **Z CR LF**

Response options:

- Z_A CR LF - command understood and in progress
- Z_D CR LF - command carried out
- Z_A CR LF - command understood and in progress
- Z_^ CR LF - command understood but zeroing range is exceeded
- Z_A CR LF - command understood and in progress
- Z_E CR LF - time limit exceeded while waiting for a stable measurement result
- Z_I CR LF - command understood but not accessible at this moment

Tare balance

Format: **T CR LF**

Response options:

- T_A CR LF - command understood and in progress
- T_D CR LF - command carried out
- T_A CR LF - command understood and in progress
- T_v CR LF - command understood but taring range exceeded
- T_A CR LF - command understood and in progress
- T_E CR LF - time limit exceeded while waiting for stable measurement result
- T_I CR LF - command understood but not accessible at this moment

Give tare value

Format: **OT CR LF**

Response: **OT_TARE CR LF** - command carried out

Response format:

1	2	3	4-12	13	14	15	16	17	18	19
O	T	Space	tare	space	unit			space	CR	LF

Tare - 9 characters with right justification

Unit - 3 characters with left justification

CAUTION!

Tare value is always given in calibration unit.

Set tare

Format: **UT_TARE CR LF**, where **TARE** – tare value

Response options:

- UT_OK CR LF - command carried out
- UT_I CR LF - command understood but not accessible at this moment
- ES CR LF - command not recognised (tare format incorrect)

CAUTION!

Use dot in tare format as decimal point.

Send stable measurement result in a basic measuring unit

Format: **S CR LF**

Response options:

- S_A CR LF - command understood and in progress
- S_E CR LF - time limit exceeded while waiting for stable measurement result
- S_I CR LF - command understood but not accessible at this moment
- MASS FRAME - response: mass value in a basic measuring unit

Response format:

1	2-3	4	5	6	7-15	16	17	18	19	20	21
S	space	stability marker	space	character	mass	space	unit			CR	LF

An example:

S CR LF - command send form a computer

S _ A CR LF - command understood and in progress

S _ _ _ _ - _ _ _ _ _ 8 . 5 _ g _ _ CR LF - command carried out, response: mass value in a basic measuring unit.

where: _ - space

Immediately send measurement result in a basic measuring unit

Format: **SI CR LF**

Response options:

SI_I CR LF - command understood but not accessible at this moment

MASS FRAME - immediate response: mass value in a basic measuring unit

Response format:

1	2	3	4	5	6	7-15	16	17	18	19	20	21
S	I	space	stability marker	space	character	mass	space	unit			CR	LF

An example:

S I CR LF - command sent from a computer

S I _ ? _ _ _ _ _ 1 8 . 5 _ k g _ _ CR LF - command carried out, immediate response: mass value in a basic measuring unit

where: _ - space

Send stable measurement result in a current measuring unit

Format: **SU CR LF**

Response options:

SU_A CR LF - command understood and in progress

SU_E CR LF - time limit exceeded while waiting for a stable measurement result

SU_I CR LF - command understood but not accessible at this moment

MASS FRAME - response: mass value in a current measuring unit

Response format:

1	2	3	4	5	6	7-15	16	17	18	19	20	21
S	U	space	stability marker	space	character	mass	space	unit			CR	LF

An example:

S U CR LF - command send form a computer

S U _ A CR LF - command understood and in progress

S U _ _ _ - _ _ 1 7 2 . 1 3 5 _ N _ _ CR LF - command carried out, response: mass value in a current measuring unit

where: _ - space

Immediately send measurement result in a current measuring unit

Format: **SUI CR LF**

Response options:

SUI_I CR LF - command understood but not accessible at this moment

MASS FRAME - immediate response: mass value in a current measuring unit

Response format:

1	2	3	4	5	6	7-15	16	17	18	19	20	21
S	U	I	stability marker	space	character	mass	space	unit			CR	LF

An example:

S U I CR LF - command sent from a computer

S U I ? _ - _ _ _ 5 8 . 2 3 7 _ k g _ CR LF - command carried out, immediate response: mass value in a current measuring unit

where: _ - space

Switch on continuous transmission in a basic measuring unit

Format: **C1 CR LF**

Response options:

C1_I CR LF - command understood but not accessible at this moment

C1_A CR LF - command understood and in progress

MASS FRAME - response: mass value in a basic measuring unit

Response format:

1	2	3	4	5	6	7-15	16	17	18	19	20	21
S	I	space	stability marker	space	character	mass	space	unit			CR	LF

Switch off continuous transmission in a basic measuring unit

Format: **C0 CR LF**

Response options:

C0_I CR LF - command understood but not accessible at this moment

C0_A CR LF - command understood and carried out

Switch on continuous transmission in a current measuring unit

Format: **CU1 CR LF**

Response options:

CU1_I CR LF - command understood but not accessible at this moment

CU1_A CR LF - command understood and in progress

MASS FRAME - response: mass value in a current measuring unit

Response format:

1	2	3	4	5	6	7-15	16	17	18	19	20	21
S	U	I	stability marker	space	character	mass	space	unit			CR	LF

Switch off continuous transmission in a current measuring unit

Format: **CU0 CR LF**

Response options:

CU0_I CR LF - command understood but not accessible at this moment

CU0_A CR LF - command understood and carried out

Set min checkweighing threshold

Format: **DH_XXXXX CR LF**, where: _ - space, **XXXXX** – mass format

Response options:

DH_OK CR LF - command carried out

ES CR LF - command not recognised (mass format incorrect)

Set max checkweighing threshold

Format: **UH_XXXXX CR LF**, where: _ - space, **XXXXX** - mass format

Response options:

UH_OK CR LF - command carried out

ES CR LF - command not recognised (mass format incorrect)

Give value of min checkweighing thresholdFormat: **ODH CR LF**Response: **DH_MASA CR LF** - command carried out

Response format:

1	2	3	4-12	13	14	15	16	17	18	19
D	H	Space	mass	space	unit			space	CR	LF

Mass - 9 characters with right justification

Unit - 3 characters with left justification

Give value of max checkweighing thresholdFormat: **OUH CR LF**Response: **UH_MASA CR LF** - command carried out

Response format:

1	2	3	4-12	13	14	15	16	17	18	19
U	H	Space	mass	space	unit			space	CR	LF

Mass - 9 characters with right justification

Unit - 3 characters with left justification

Set mass value of a single item (only for PARTS COUNTING)Format: **SM_XXXXX CR LF**, where: _ - space, XXXXX – mass format

Response options:

SM_OK CR LF - command carried out

SM_I CR LF - command understood but not accessible at this moment (e.g. mode other than PARTS COUNTING)

ES CR LF - command not recognised (mass format incorrect)

Set target mass value (e.g. for DOSING)Format: **TV_XXXXX CR LF**, where: _ - space, XXXXX - mass format

Response options:

TV_OK CR LF - command carried out

TV_I CR LF - command understood but not accessible at this moment (e.g. mode other than DOSING)

ES CR LF - command not recognised (mass format incorrect)

Set reference mass value (e.g. for DEVIATIONS)Format: **RM_XXXXX CR LF**, where: _ - space, XXXXX – mass format

Response options:

RM_OK CR LF - command carried out

RM_I CR LF - command understood but not accessible at this moment (e.g. mode other than DEVIATIONS)

ES CR LF - command not recognised (mass format incorrect)

Value releaseFormat: **SS CR LF**

Response options:

SS_OK CR LF - command understood and in progress

Command's function is similar to function of PRINT button located on an overlay,

Internal adjustmentFormat: **IC CR LF**

Response options:

IC_A CR LF - command understood and in progress

IC_D CR LF - calibration completed
IC_A CR LF - command understood and in progress
IC_E CR LF - time limit exceeded while waiting for a stable measurement result
IC_I CR LF - command understood but not accessible at this moment

Disable automatic internal adjustment of the balance

Format: IC1 CR LF

Response options:

IC1_I CR LF - command understood but not accessible at this moment
IC1_E CR LF - operation disabled, e.g. for verified balance
IC1_OK CR LF - command carried out

Operation is disabled for verified balances.

For non-verified balances the command inhibits internal calibration until it is enabled via IC0 command or until the balance is turned off. The command does not modify settings specifying calibration start.

Enable automatic internal adjustment of the balance

Format: IC0 CR LF

Response options:

IC0_I CR LF - command understood but not accessible at this moment
IC0_OK CR LF - command carried out

Operation is disabled for verified balances.

Give balance serial number

Format: NB CR LF

Response options:

NB_A_"x" CR LF - command understood, response: serial number
NB_I CR LF - command understood but not accessible at this moment
x – serial number of the device (inserted in between inverted commas)

An example:

Command: NB CR LF – return serial number

Response: NB_A_"1234567" – serial number of the device – "1234567"

Lock balance keypad

Format: K1 CR LF

Response options:

K1_I CR LF - command understood but not accessible at this moment
K1_OK CR LF - command carried out

Command locks the balance keypad (proximity sensors, touch panel) until the moment of turning the balance off or until sending K0 command

Unlock balance keypad

Format: K0 CR LF

Response options:

K0_I CR LF - command understood but not accessible at this moment
K0_OK CR LF - command carried out

Give available working modes

Command overview: Command returns accessible working modes.

Format: OMI CR LF

Response options:

OMI CR LF

n_"Made name" CR LF: – command carried out, response: accessible working modes
n_"Made name" CR LF

OK CR LF

OMI_I CR LF – command understood but not accessible at this moment

Mode name – parameter, working mode name, inserted in between inverted commas. The

name takes form given on a particular balance display, it is provided in a currently selected language.

n – parameter, decimal value determining working mode number.

n →

1	– Weighing
2	– Parts Counting
3	– Deviations
4	– Dosing
5	– Formulas
6	– Animal Weighing
8	– Solids Density
9	– Liquids Density
10	– Peak Hold
11	– Totalizing
12	– Checkweighing
13	– Statistics

CAUTION! Working modes numbering is identical for each kind of balance. The numbers are assigned to working modes names. Some balances give only the number as a response.

An example

1:

Command:	OMI CR LF	– return accessible working modes
Response:	OMI CR LF	
	2_” Parts counting” CR LF	– accessible working modes are given in return:
	4_” Dosing” CR LF	mode number + name
	12_”Checkweighing” CR LF	
	OK CR LF	– command carried out

An example

2:

Command:	OMI CR LF	– return accessible working modes
Response:	OMI CR LF	
	2 CR LF	– accessible working modes are given in return:
	4 CR LF	mode number
	12 CR LF	
	OK CR LF	– command carried out

Set working mode

Command overview: Command sets particular working mode.

Format: OMS_n CR LF

Response options:

OMS_OK CR LF	– command carried out
OMS_E CR LF	– error in-course of command execution, no parameter or incorrect format
OMS_I CR LF	– command understood but not accessible at this moment

n – parameter, decimal value determining working mode number. To see detailed description go to OMI command

An example:

Command:	OMS_13 CR LF	– set Statistics mode
Response:	OMS_OK CR LF	– Statistics mode set

Give current working mode

Command overview: Command returns currently set working mode.

Format: OMG CR LF

Response options:

OMG_n_OK CR LF	– command carried out, response: current working mode
----------------	---

OMG_I CR LF – command understood but not accessible at this moment
n – parameter, decimal value determining working mode number. To see detailed description go to OMI command.

An example:

Command: OMG CR LF – return current working mode
Response: OMG_13_OK CR LF – balance operates in Statistics working mode

Give accessible units

Command overview: Command returns units available for a particular device and for a current working mode.

Format: UI CR LF

Response options:

UI_”x₁,x₂, ... x_n”_OK CR LF – command carried out, returns accessible units
UI_I CR LF – command understood but not accessible at this moment

x – unit symbols, separated by means of comas

x → g, mg, ct, lb, oz, ozt, dwt, tlh, tls, tlt, tlc, mom, gr, ti, N, baht, tola, u1, u2

An example:

Command: UI CR LF – return available units
Response: UI_”g, mg, ct”_OK CR LF – response: available units

Set current unit

Command overview: Command sets current unit for a particular device.

Format: US_x CR LF

Response options:

US_x_OK CR LF – command carried out, response: current unit
US_E CR LF – error in-course of command execution, no parameter or incorrect format
US_I CR LF – command understood but not accessible at this moment

x – parameter, units symbols: g, mg, ct, lb, oz, ozt, dwt, tlh, tls, tlt, tlc, mom, gr, ti, N, baht, tola, msg, u1, u2, next

CAUTION! if x=next, the command swaps to another available unit on the list (it simulates „unit” button pressing).

An

example:

Command: US_mg CR LF – set „mg” unit
Response: US_mg_OK CR LF – „mg” set as a current unit

Give current unit

Command overview: command returns current unit.

Format: UG CR LF

Response options:

UG_x_OK CR LF – command carried out, response: current unit
UG_I CR LF – command understood but not accessible at this moment

x – parameter, unit symbol

An example:

Command: UG CR LF – return current unit
Response: UG_ct_OK CR LF – currently set unit is „ct”

Activate sound signal

Command overview: command activates BEEP sound signal for a specified amount of time

Format: BP_CZAS CR LF

Response options:

BP_OK CR LF – command carried out, BEEP sound signal activated
BP_E” CR LF – no parameter or incorrect format
BP_I CR LF – command understood but not accessible at this moment

TIME – parameter, decimal value specifying how long shall the sound last, parameter given in [ms].

Recommended range <50 ÷ 5000>.

If value greater than the permissible high limit is given, than BEEP sound is operated for the maximum permissible amount of time.

An example:

Command: BP_350 CR LF – activate BEEP for 350 ms

Response: BP_OK CR LF – BEEP activated

CAUTION!

BEEP sound activated via BP command is inhibited if in-course of its activation the sound is activated by means of other device: keypad, touch panel, proximity sensors.

Send all implemented commands

Format: PC CR LF

Command: PC CR LF - send all implemented commands

Response: PC_A_”Z,T,S,SI...” - command carried out, the terminal displays all implemented commands.

Give balance type

Format: BN CR LF

Response options:

BN_A_”x” CR LF - command understood, response: balance type

BN_I CR LF - command understood but not accessible at this moment

x – series of types for a particular balance (in between inverted commas), with general balance type in front

An example:

Command: BN CR LF – return balance type

Response: BN_A_”AS” – balance type: ”AS R”

Give max capacity

Format: FS CR LF

Response options:

FS_A_”x” CR LF - command understood, response: Max capacity

FS_I CR LF - command understood but not accessible at this moment

x – Max value of reading units (in between inverted commas)

An example:

Command: FS CR LF – return Max capacity

Response: FS_A_”220.0000” – Max capacity: ”220 g”

Give program version

Format: RV CR LF

Response options:

RV_A_”x” CR LF - command understood, response: program version

RV_I CR LF - command understood but not accessible at this moment

x – program version (in between inverted commas)

An example:

Command: RV CR LF – return program version

Response: RV_A_”1.1.1” – program version: ”1.1.1”

Set AUTOZERO function

Format: A_n CR LF

Response options:

A_OK CR LF – command carried out

A_E CR LF – error in-course of command execution, no parameter or incorrect format

A_I CR LF – command understood but not accessible at this moment

n – parameter, decimal value determining autozero settings

n → 0 – autozero off

1 – autozero on

CAUTION!

Command changes settings for a current working mode.

An example:

Command: A_1 CR LF – turn autozero function on
 Response: A_OK CR LF – autozero function is on
 AUTOZERO function operates until it is turned off by A 0 command.

Set ambient conditions state

Format: EV_n CR LF

Response options:

EV_OK CR LF – command carried out

EV_E CR LF – error in-course of command execution, no parameter or incorrect format

EV_I CR LF – command understood but not accessible at this moment

n – parameter, decimal value determining ambient conditions state

n → 0 – unstable ambient conditions

1 – stable ambient conditions

CAUTION!

Command changes settings for a current working mode.

An example:

Command: EV_1 CR LF – set value 'stable' for ambient conditions option

Response: EV_OK CR LF – ambient conditions option set to value 'stable'

<AMBIENT CONDITIONS> parameter is set to value <STABLE> until command EV 0 swaps it to value <UNSTABLE>.

EVG – Give currently set ambient conditions

Command overview:

On receipt of a command, the terminal sends information on currently set ambient conditions.

Format: **EVG <CR><LF>**

Response options:

EVG_x_OK<CR><LF> – command carried out, returns set ambient conditions

EVG_I <CR><LF> – command understood but not accessible at this moment

x - parameter, ambient conditions symbols

Example:

Command: EVG<CR><LF> – give currently set ambient conditions

Response: EVG_0_OK<CR><LF> – currently set ambient conditions unstable

Set filter

Format: FIS_n CR LF

Response options:

FIS_OK CR LF – command carried out

FIS_E CR LF – error in-course of command execution, no parameter or incorrect format

FIS_I CR LF – command understood but not accessible at this moment

n – parameter, decimal value determining filter number

n → 1 – very fast

2 – fast

3 – average

4 – slow

5 – very slow

CAUTION!

The numbering is assigned to a particular filter name and it is identical for all balance types.

The command changes settings for a current working mode if, for a particular balance type, filter settings are assigned to the working mode.

An example:

Command: FIS_3 CR LF – set average filter

Response: FIS_OK CR LF – average filter set

FIG – Give current filter

Command overview:

On receipt of a command, the terminal sends information on currently set filter.

Format: **FIG <CR><LF>**

Response options:

FIG_x_OK<CR><LF> - command carried out, returns set filter

FIG_I <CR><LF> - command understood but not accessible at this moment

x - parameter, filter symbols

Example:

Command: FIG<CR><LF> - give current filter

Response: FIG_2_OK<CR><LF> - currently set average filter

Set Value release

Format: ARS_n CR LF

Response options:

ARS_OK CR LF – command carried out

ARS_E CR LF – error in-course of command execution, no parameter or incorrect format

ARS_I CR LF – command understood but not accessible at this moment

n – parameter, decimal value determining value release options

n → 1 – fast

2 – fast+reliable

3 – reliable

CAUTION!

The numbering is assigned to a particular value release option and it is identical for all balance types.

The command changes settings for a current working mode if, for a particular balance type, value release settings are assigned to the working mode

An example:

Command: ARS_2 CR LF – set value release parameter to fast+reliable option

Response: ARS_OK CR LF – fast+reliable option set

ARG – Give current value release

Command overview:

On receipt of a command, the terminal sends information on currently value release.

Format: **ARG <CR><LF>**

Response options:

ARG_x_OK<CR><LF> - command carried out, returns set value release

ARG_I <CR><LF> - command understood but not accessible at this moment

x - parameter, value release symbol

Example:

Command: ARG<CR><LF> - give current value release

Response: ARG_2_OK<CR><LF> - currently set value release parameter to fast+reliable option

Set last digit

Format: LDS_n CR LF

Response options:

LDS_OK CR LF – command carried out

LDS_E CR LF – error in-course of command execution, no parameter or incorrect format

LDS_I CR LF – command understood but not accessible at this moment

n – parameter, decimal value determining last digit settings

- n → 1 – always
- 2 – never
- 3 – when stable

CAUTION!

The numbering is assigned to a particular last digit option and it is identical for all balance types.

The command changes settings for a current working mode if, for a particular balance type, last digit settings are assigned to the working mode.

An example:

Command: LDS_1 CR LF – set last digit option to value ‘always’

Response: LDS_OK CR LF – ‘always’ value set

Cooperation with PUE 7.1, PUE 10 terminal

Format: NT CR LF

Response options:

ES CR LF – command not understood (format error)

MASS FRAME – response: mass value in a basic measuring unit

Response format:

1	2	3	4	5	6	7	8	9-18	19	20-22	23	24-32	33	34-36	37	38	39	40
N	T	space	stability marker	zero marker	range marker	digit marker	space	mass	space	mass unit	space	tare	space	tare unit	space	Hidden digits quantity	CR	LF

NT – command

Stability marker – [space] if stable, [?] if unstable

Zero marker – [space] for any value but zero, [Z] for zero value

Range marker – marker informing on range within which mass value is comprised: [space] I range balance, [2] II balance, [3] III balance

Digit marker [zero] no digit, [1] one digit marker, [2] two digits marker, [3] three digits marker, [4] four digits marker, [5] five digits marker

Mass 10 characters for net mass given in adjustment unit (with dot and a floating-point “-“ sign)

Mass unit 3 characters with left justification

Tare 9 characters with dot - right justification (when floating-point tare gets turned off automatically then zero value is sent)

Tare unit 3 characters with left justification

Hidden digits quantity Number specifying quantity of hidden digits: [space] when no digits are hidden, [1] when 1 digit is hidden

An example:

NT CR LF – command sent from a computer

NT _ ? _ _ 0 _ _ _ _ - 5 . 1 1 3 _ g _ _ _ _ _ 0 . 0 0 0 _ g _ _ _ 0 CR LF – command carried out, response: mass value and remaining data

Where: _ - space

8. KEYPAD

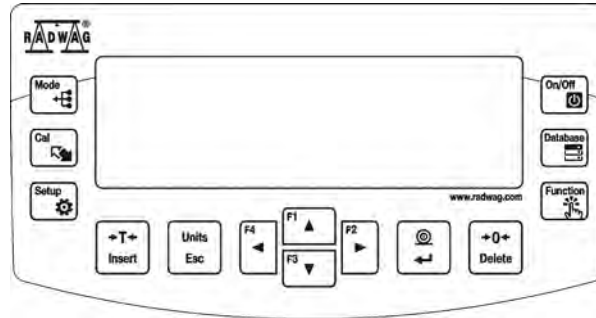

	ON/OFF key for enabling/disabling module display. Upon switching the display off, the other subassemblies remain powered and the weighing instrument is ready for operation. F9 key of the computer keyboard.
	Direct access to data saved to the module databases: operator, product, tare. F10 key of the computer keyboard.
	Function key, enables quick entering the settings of selected working mode. F11 key of the computer keyboard.
	MODE key - selecting working mode. F5 key of the computer keyboard.
	UNITS key enables changing measuring units.
	PRINT/ENTER key - enables sending the result to the peripheral device (PRINT) or accepting selected parameter or function value (ENTER).
	ZERO key – enables zeroing module indication.
	TARE key –enables taring module indication.
	Key for starting the adjustment of the module. F6 key of the computer keyboard.
	Press to enter module main menu. F7 key of the computer keyboard.
	Keys enabling navigating module menu or changing parameters settings.

Caution:

Enabling certain operations in the software can be done by pressing respective key located on the panel (as described in this user manual) or by sending respective command using computer.

For a list of commands and their operation refer to the **COMMUNICATION PROTOCOL** section.

8.1. Operator Menu

The menu is divided into **9** basic function groups. Each group has individual name starting with capital letter **P**.

P1 ADJUSTMENT

P1.1 INT. ADJ.	[internal adjustment]
P1.2 EXT. ADJ.	[external adjustment]
P1.3 USER ADJ.	[user adjustment]
P1.4 ADJ. TEST	[adjustment test]
P1.5 AUTO ADJ.	[automatic adjustment]
P1.6 AUTO ADJ TME.	[time of automatic adjustment]

P2 WORKING MODE

P2.1 AVAILABILITY	[availability of the working modes during module operation]
P2.2 WEIGHING	[weighing mode settings]
P2.3 PRTS. CNT.	[parts counting mode settings]
P2.4 CHECKWEIGHING	[checkweighing mode settings]
P2.5 DOSING	[dosing mode settings]
P2.6 PRCT. WEIGH.	[percent weighing mode settings]
P.2.7 DENS. OF SOLIDS	[solids density mode settings]
P2.8 DENS. OF LIQUIDS	[liquids density mode settings]
P2.9 ANIMAL WEIGHING	[animals weighing mode settings]
P2.10 STATISTICS	[statistics mode settings]
P2.11 TOTALIZING	[totalizing mode settings]
P2.12 PEAK HOLD	[peak hold mode settings]
P2 13 PIPETTES CAL.	[pipettes calibration mode settings]

P3 COMMUNICATION

P3.1 COM 1	[COM 1 transmission parameters]
P3.2 COM 2	[COM 2 transmission parameters]
P3.3 WIFI	[Wi-Fi parameters]

P4 PERIPHERALS

P4.1 COMPUTER	[settings for computer-module connection]
P4.2 PRINTER	[settings for printer-module connection]
P4.3 BARCODE SCANNER	[barcode scanner port]
P4.4 ADD. DISPLAY	[additional display port]
P4.5 EXT. BUTTONS	[enabling/disabling external buttons]

P5 PRINTOUT

P5.1 ADJ. REPORT	[adjustment report content]
P5.2 HEADER	[header content]
P5.3 GLP PRNT.	[footer content]
P5.4 FOOTER	[weighing result content]
P5.5 NSD.PRN.1	[non-standard printout no. 1]
P5.6 NSD.PRN.2	[non-standard printout no. 2]
P5.7 NSD.PRN.3	[non-standard printout no. 3]
P5.8 NSD.PRN.4	[non-standard printout no. 4]
P5.9 VARIABLE 1	[variable 1 project]
P5.10 VARIABLE 2	[variable 2 project]

P6 MISC.

P6.1 LANGUAGE	[menu language]
P6.2 PERMISSIONS	[permission level required for editing menu]
P6.3 KEY SOUND	[keys sounds]
P6.4 BACKLIGHT	[display backlight level]
P6.5 BACKLIGHT OFF	[backlight time-out]
P6.6 AUTO OFF	[display time-out]
P6.7 DATE	[data settings]
P6.8 TIME	[time settings]
P6.9 DATE FORM.	[date format]
P6.10 TIME FORM.	[time format]
P6.11 GLP AUTOTEST	[module autotest]

P7 INFO

P7.1 BALANCE S/N	[weighing instrument S/N]
P7.2 BALANCE TYPE	[weighing instrument type]
P7.3 SOFT. VER.	[program version]
P7.4 TEMP.	[temperature]
P7.5 SETUP PRNT.	[weighing instrument parameters printout]

P8 UNITS

P8.1 AVAILABILITY	[declaring units to be available while operating the module]
P8.2 START UNIT	[selecting unit to be run on module start-up]
P8.3 CUST. UNIT1	[parameter allowing to define first unit to be used]
P8.3 CUST. UNIT2	[parameter allowing to define second unit to be used]

P9 IMPORT/EXPORT (parameter displayed upon plugging the flash drive to the weighing instrument)

IE 1 EXPORT	[data export]
IE 2 IMPORT	[data import]





Caution:

*Introduced modifications are permanently recorded into balance memory upon return to the weighing operation after carrying out saving procedure. In order to exit the menu, press **Esc** key repeatedly.*



8.2. Log in Operation

In order to access operator-related parameters and in order to edit databases, you need to log in as an operator with **<ADMINISTRATOR>** permissions level. The software allows you to enter 100 operators with various permissions levels.

First log in operation:

- In a home screen, select **<LOG IN>** parameter which is available upon:
 - pressing  key,
 - pressing function key to which **<LOG IN>** parameter is assigned,
 - pressing  key,

next, enter operators database and select **<ADMIN>**.

- Upon selecting **< ADMIN >** and pressing  key to confirm, the edit box for entering password is displayed.
- Enter „1111” password and press  key to confirm.
- The home screen is displayed.
- When logged, add operators and set the permission levels, for detailed procedure read section: 9.1).

While Logging In again, select an operator from the list and enter the password, the software initiates operation with permission level set for the selected operator.

If any operator is logged in, the following pictogram is displayed: .

Log out Procedure

- Select **<NONE>** parameter out of the list of available operators.
- Home screen is displayed again and the display shows no logged-in operator (no  pictogram).

8.3. Units

P8 UNITS parameter group enables you to specify which mass units are to be available in the course of operation, and to define two custom units. These two options improve both comfort and speed of work.

You can change unit [g] to some other unit during the weighing process or during operation of other modes. PARTS COUNTING and PERCENT WEIGHING modes are exceptions for which the unit cannot be changed.

8.4. Temporary Weighing Unit Selection

Function enables selecting mass indication unit. Temporary unit remains active until it is changed or the balance is turned off. Each pressing of  key causes unit change.

Units list:

- For verified weighing instruments, you can select the following units: [g], [mg] or [kg], [ct].
- For unverified weighing instruments, you can select the following units: [g], [mg], [kg], [ct], [lb], [oz], [ozt], [dwt], [tlh], [tls], [tit], [tlc], [mom], [gr], [ti], [N].

8.5. Weighing Units Availability

You can declare which units are to be accessible upon pressing  key. Units with parameter value set to **<Yes >** option are available for selection in particular working modes, i.e. modes facilitating units change.

Procedure:

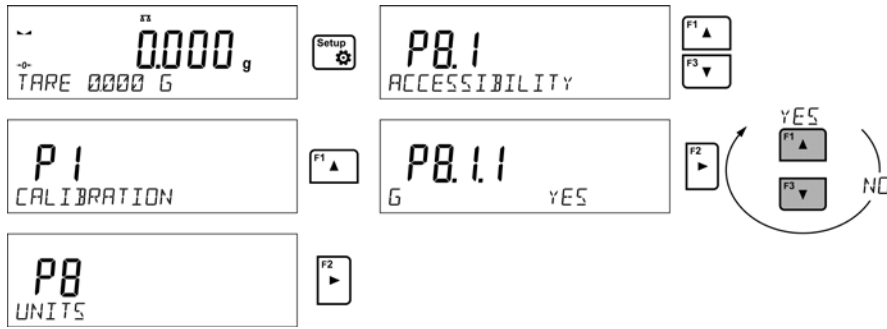

8.6. Start Unit Selection

Upon setting start unit, the balance activates with the set start unit for these modes where change of the unit is possible.
 Availability of particular units is conditioned by the weighing instrument status; i.e. it depends on the fact whether the given balance is verified or not.

Procedure:



8.7. Custom Unit

It is possible to declare two custom units. Custom unit is the result of multiplying the weighing instrument indication by the factor entered for particular custom unit.
 By default, custom units are marked as: **[u1]** – custom unit 1 and **[u2]** – custom unit 2.

Procedure of setting the factor for custom unit:



Custom units are available only for unverified weighing instruments.

9. MISCELLANEOUS

You can set up parameters which influence balance operation. The parameters are to be found in **P6 MISC.** menu.

Settings modification for particular parameters of this menu proceeds likewise as described in the previous section.

Menu language

Parameter allowing you to set program menu language.

Available languages: POLISH, ENGLISH, GERMAN, SPANISH, FRENCH, TURKISH, CZECH, ITALIAN, HUNGARIAN.

Permissions levels

Parameter allowing you to set permissions level for unlogged operator.

Permissions levels: ADMIN. / OPERATOR / ADV..

Depending on selected permissions level, you can enter balance parameters and modify the settings, as far as possible for a particular level (for permissions overview read section 9.1 of this user manual).

'Beep' Sound

Parameter allowing you to enable/disable sound signal informing the operator about pressing panel key(s).

NO - disabled

YES - enabled

Backlight and display brightness adjustment

The parameter enables setting display brightness. The backlight can be disabled completely.

100 - maximum brightness

10 - minimum brightness

NONE - backlight disabled.

Backlight Standby Time

<P6.5 STAND-BY MODE> parameter allows you to set time interval, in [min], after which the screen goes black when no weighings are being carried out. The screen will go black if the weighing result is stable.

NONE - backlight standby time inactive; **0.5; 1; 2; 3; 5** - time given in minutes.

If the indication is stable during the declared time interval, the backlight gets deactivated automatically.

Backlight activates upon indication change (stability pictogram not displayed) or upon pressing operation panel key.

Backlight deactivation works also when the weighing instrument's menu is entered.

Automatic Shutdown

<P6.6 AUTO OFF> parameter allowing you to set time interval, in [min], after which the weighing instrument shuts down automatically (this function is similar to function of  key). Upon switching the display off, the other subassemblies remain powered and the weighing instrument is ready for operation.

NONE - automatic shutdown inactive, ; **1; 2; 3; 5; 10** - time given in minutes.

If the indication is stable during the declared time interval, the backlight gets deactivated automatically.

In order to switch the weighing instrument on, press  key of the operation panel. Weighing process gets started automatically.

Shutdown function is inactive and the device cannot be turned off if any process is started or if you operate the menu.

Date

Enter this parameter to set current date.

Setting:



Time

Enter this parameter to set current time.

Setting:



Date Format

Enter this parameter to set date format on the printout.

[YYYY.MM.DD / YYYY.DD.MM / DD.MM.YYYY / MM.DD.YYYY].

Where: YYYY – year; MM – month; DD – day.

Time Format

Enter this parameter to set time format [12h/24h].

For [12H] value set for <P6.6 TIME> parameter, <A> or <P> letter is displayed next to the time.

Where: **A** stands for hours before the noon, **P** stands for hours after the noon. Time printout features either letters **AM** or **PM**.

Autotest GLP

<AUTOTEST> function has been designed to aid an operator in assessing balance's operation and diagnosing the reasons for occurrence of weighing errors (exceeding the maximum permissible values for a given balance model).

AUTOTEST facilitates balance's settings optimisation which is necessary in order to maintain the best possible repeatability and weighing time at workstation. The function makes it possible to monitor the above-mentioned parameters at optional moment and archive tests results in the form of reports that are automatically generated at the end of control procedure.

Autotest GLP is a function based on the test of repeatability of indications observed while loading an internal weight onto the weighing pan, which is done in order to determine indication error. The error is determined in reference to the maximum capacity.

Procedure:

- load internal weight twice, next load internal weight ten times and calculate the value of standard deviation,
- adjust the weighing instrument,
- print a report.

Test results provide weighing instrument data, calculated error for Max capacity and value of repeatability of indication expressed as standard deviation.



Report example:



.....
Autotest GLP Report -----
Balance type PS 3000.R2
Balance S/N 400010
Operator Admin
Software version v.0.4.9
Date 2013.07.16
Time 09:17:16

Measurements quantity 10
Reading unit 0.001/0.01 g
Adjustment weight mass 1402.094 g
Filter Average
Value release Fast and rel.

Deviation for max -0.118 g
Repeatability 0.0088 g
Signature
.....

Procedure:

Enable <P6.11 GLP Autotest> parameter by pressing  key. Autotest GLP procedure starts, it is carried out automatically. Press  key to abort the procedure, you can do it at any time.

Upon completed procedure, the value of standard deviation of all measurements is displayed with the <RESULT> value. The end report is automatically printed (report example is presented above). The report can be printed repeatedly, press  key. The report is not saved and is deleted from the memory upon exiting the menu. In order to return to the menu press  key.

10. ADJUSTMENT

In order to ensure the highest weighing accuracy, it is recommended to periodically introduce a corrective factor of indications to balance memory, the said factor must be referred to a reference mass. It is a balance adjustment.

Adjustment has to be carried out:

- prior weighing,
- if long breaks between successive measuring series occur,
- if the weighing instrument temperature has changed by 1°C, or 2°C (AS, PS and APP series).

Types of adjustment:

- automatic internal adjustment,
- manual internal adjustment,
- adjustment performed using an external weight of declared mass, which mass cannot be modified, or using an external weight of mass equal or greater than 30% of the maximum range.

**Caution:**

In case of verified balances (with an internal automatic adjustment system) only two adjustment types are available: automatic internal adjustment and manual internal adjustment. Remember to carry out the adjustment process when there is no load on the pan!

When the weighing pan is loaded, command **<RANGE EXCEEDED>** is displayed. In such case, unload the weighing pan and repeat the adjustment. adjustment process can be aborted if necessary, to do it press **Esc** key.

10.1. Internal adjustment

Adjustment can be initiated automatically or manually.

Manual adjustment starts upon pressing  key. Next, automatic adjustment system carries out adjustment process and informs you about next steps.

Automatic adjustment is carried out as follows:

- Weighing instrument software detects the need for carrying out adjustment process and signals it using thermometer or clock pictograms and **<Cal>** message displayed in the top part of the display . You have 2 minutes to carry out subsequent weighings.
- After this time **<CAL_30>** message is displayed and the countdown starts: 30..29..28 to 0 (the time).
- Do not attempt to perform any operations during this time.
- To complete the measurements press **<Esc>** key. The balance returns to weighing mode and displays previous measurement result. After 5 minutes, **<CAL 30>** message is displayed again.
- Adjustment can be delayed repeatedly, but you have to remember that too many delays cause larger errors during weighing. Errors are caused by temperature and sensitivity changes.

Automatic adjustment is carried out in 3 cases:

- Triggered by plugging the instrument to the mains - verified instruments.
- Internal adjustment triggered by temperature change. The weighing instrument is equipped with temperature monitoring system. adjustment temperature is registered each time. Next adjustment process is initiated when the temperature changes by: 1°C or 2°C (AS PS and APP series).
- Adjustment triggered upon passage of specified time interval. You can declare time intervals between adjustments (option available for unverified weighing instruments).

10.2. Adjustment Menu

- **P1.1 INT. ADJ. - internal adjustment**

Internal adjustment process start. The whole process is carried out automatically, without operator assistance. If the weighing pan is loaded, a message to unload the weighing pan is displayed. If the load on the weighing pan is small (up to $\pm 10\%$ of max capacity), the weighing instrument is adjusted automatically without unloading the weighing pan

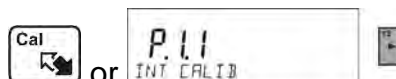

- **P1.2 EXT. ADJ. - External adjustment using external weight**

Adjustment carried out using external weight which value is saved in the instrument factory menu (option unavailable for verified weighing instruments).

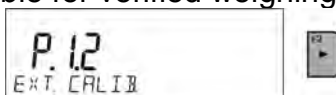

- **P1.3 USER. - User adjustment carried out using external weight**

Adjustment carried out using weight of mass equal to or greater than 30% of the maximum capacity (option unavailable for verified weighing instruments).



- **P1.4 ADJ. TEST - adjustment test**

Adjustment test is carried out by comparing the adjustment mass with its value saved to the weighing instrument memory. The process is carried out automatically and its result is presented on the display (if the weighing instrument is connected to a computer or a printer using communication interface, adjustment test result is printed out). Press **Esc** key to return to the previous screen.

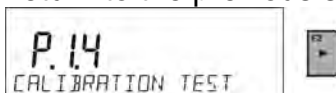

- **P1.5 AUTO. ADJ. TMP. - Automatic adjustment**

Specifying the factor that determines internal automatic adjustment start (option unavailable for verified weighing instruments).

NONE - none of the factors causes adjustment start (option unavailable for verified weighing instruments).

TEMP - adjustment triggered by temperature change.

TIME - adjustment triggered by the time set in **P1.6 AUTO ADJ. TME.** parameter

BOTH - adjustment triggered by both the time and temperature change.

- **P1.6 AUTO ADJ. TME. - Automatic adjustment time**

Determining the time after which automatic adjustment starts (option unavailable for verified weighing instruments).

10.3. Manual adjustment

10.3.1. Internal Adjustment

The weighing instrument carries out automatic internal adjustment. Do not load the weighing pan during internal adjustment. Message: **<DO NOT SWITCH OFF>** is displayed in the bottom part of the display. Upon adjustment completion the weighing instrument saves its results to the memory and returns to weighing.

Caution:



- To abort adjustment process press **Esc** key.



- If the weighing pan during adjustment is loaded, the error message is displayed.

Adjustment process is aborted and the weighing instrument returns to weighing. Upon unloading the weighing pan, you can repeat adjustment.

10.3.2. External adjustment

External adjustment is carried out using external weight of class F₁ – for PS series (option unavailable for verified weighing instruments).



Procedure:

- Start external adjustment. Message **<UNLOAD PAN>** is displayed (weighing pan has to be unloaded). Upon unloading the weighing pan, press  key.
- The weighing instrument determines mass of an empty weighing pan, **<ADJUSTMENT>** message is displayed in the bottom part of the display. Next, message **<LOAD WEIGHT >** is displayed along with mass value to be put onto weighing pan; e.g.. **200.000g** (depending on balance type).
- Put the weight of a given mass and press  key. The weighing instrument determines mass and **<ADJUSTMENT>** message is displayed. Upon adjustment completion submenu **<P1.2 EXT. ADJ.>** is displayed.

10.3.3. User Adjustment

External adjustment is carried out using external weight of class F₁ – for PS series (option unavailable for verified weighing instruments).

Procedure:

- Set mass of the weight used for adjustment process. Mass of the weight has to be equal or greater than $\geq 30\%$ of maximum capacity.
- On entering and confirming the weight mass, message **<UNLOAD PAN>** is displayed (the weighing pan has to be unloaded). Upon unloading the weighing pan, press  key.
- The weighing instrument determines mass of an empty weighing pan, **<ADJUSTMENT>** message is displayed in the bottom part of the display. Next, message **<LOAD WEIGHT >** is displayed along with mass value to be put onto weighing pan; e.g.. **200.000g** (depending on balance type).
- Put the weight of a given mass and press  key. The weighing instrument determines mass and **<ADJUSTMENT>** message is displayed. Upon adjustment completion **<P1.2 EXT. ADJ.>** submenu is displayed.

10.4. Adjustment Report Printout

Adjustment report is automatically generated at the end of each adjustment process or adjustment test and sent to COM 1 interface. To declare report content go to P5.1 ADJ. REPORT menu.

For instruction on how to declare adjustment report settings read section 'Printouts'.

The report can be printed using printer connected to the balance or sent to a computer and saved as a file for the archiving purposes.

11. PRINTOUTS CONTENT

11.1. Adjustment Report

P5.1 ADJ. REPORT is a group of parameters allowing you to declare data that is to be printed on an adjustment report.

<i>Variable</i>	<i>Description</i>
PROJECT	Project name matching particular weighing type. The name can consist of 16 characters maximum.
ADJ. TYPE	Carried out adjustment type.
OPERATOR	Logged in operator name.
PROJECT	Project name (read: <i>Project</i> parameter).
DATE	Adjustment performance date.
TIME	Adjustment performance time.
BALANCE S/N	Balance serial number.
ADJ. DIFFER.	The difference between mass of adjustment weight that was measured during last adjustment and mass of currently measured adjustment weight.
DASHES	Line separating data and signature fields on a printout.
SIGNATURE	An area for the signature of an operator carrying out the adjustment.

For the parameters described above, one of these values must be selected:

NO - do not print.

YES - print.

Report example:

-----Cal. Report-----	
Calib. type	Internal
User	Admin
Project	Project name-1
Date	04.06.2013
Time	10:54:27 AM
Balance ID	353870
Cal. differ.	0.045 g

Signature:	
.....	

11.2. Header, Footer, GLP Printouts

HEADER	Group of parameters allowing you to declare data that is to be printed on a header printout.
GLP PRINTOUT	Group of parameters allowing you to declare data that is to be printed on a measurement printout.
FOOTER	Group of parameters allowing you to declare data that is to be printed on a footer printout.

Variables List

<i>Variable</i>	<i>Description</i>	<i>Active for</i>
WORKING MODE	Working mode name.	Header Footer
BALANCE TYPE	Balance type.	Header Footer

BALANCE S/N	Balance serial number.	Header Footer
OPERATOR	Logged in operator name.	Header GLP Printout Footer
PRODUCT	Name of currently selected product.	Header GLP Printout Footer
DATE	Printout date.	Header GLP Printout Footer
TIME	Printout time.	Header GLP Printout Footer
VARIABLE 1	VARIABLE 1 value.	Header GLP Printout Footer
VARIABLE 2	VARIABLE 2 value.	Header GLP Printout Footer
NET	Net weight value in a basic unit (adjustment unit).	GLP Printout
TARE	Tare weight value in the current unit.	GLP Printout
GROSS	Gross weight value in current unit.	GLP Printout
CURR. RES.	Current result (net weight value) in a current unit.	GLP Printout
ADJ. REPORT	The most recent adjustment report printed according to the settings declared for the adjustment report printout (read: section 14.1 of this user manual).	Header GLP Printout Footer
DASHES	Line separating data and signature fields on a printout.	Header Footer
EMPTY LINE	Separating empty line.	Header Footer
SIGNATURE	An area for the signature of an operator carrying out the adjustment.	Footer
NSD. PRN.	One of 100 non-standard printouts.. For instruction on how to enter non-standard printouts read later section of this user manual.	Header GLP Printout Footer

For the parameters described above, one of these values must be selected:

NO - do not print

YES - print

Printout examples:

```

-----
Working modes      Weighing
Date              24.07.2013
Time              7:37:30
ScaleType         AS
Balance ID        10353870
User              ADMIN ENG
Product           Tablet

```

Header

```

Date              04.06.2013
Time              11:11:24 AM
Product           NAZWA
0.000 g

```

GLP Printout

```

-----
Date              24.07.2013
Time              7:41:10
User              ADMIN ENG
Signature
.....

```

Footer

11.3. Non-standard Printouts

The program allows you to design 4 non-standard printouts. Each can consist of 160 characters maximum.

Non-standard printout may include:

- variable data conditioned by a particular working mode and operator needs (mass, date etc.),
- fixed texts, entered into operator's menu; remember to use capital letters only, avoid using special characters,
- non-standard printout can consists of 160 characters maximum (entered as the string).

11.3.1. Inserting Texts

Variables consisting in all working modes and having the same values:

%%	'%' single character printout
%V	Current net weight in a current unit
%N	Current net weight in a basic unit
%G	Current gross weight in a basic unit
%T	Current tare value in a basic unit
%D	Current date
%M	Current time
%I	Balance number
%R	Program number
%P	Project number
%U	Operator number
%F	Working mode name
%C	Date and time of the last adjustment
%K	Type of the last adjustment
%S	Currently selected (weighed) product
%Y	Deviation in the last adjustment
%1	Variable 1
%2	Variable 2

Variables dependent on the currently used working mode:

<i>Variable</i>	<i>Description</i>	<i>Working mode</i>
%W	Mass standard of 1 pc.	PARTS COUNTING
%H	HI threshold	CHECKWEIGHING
%L	LO threshold	
%A	Target mass	DOSING
%B	Reference mass	PERCENT WEIGHING

Variables used to design non-standard printouts:

\\	single „\” character
\C	CRLF
\R	CR
\N	LF
\T	Tab key
\F	Form feed for PCL printers
%E	Paper crop EPSON

Each of them can consist of 160 characters maximum (letters, digits, special signs, spaces). You can apply non-standard characters, i.e. special signs, which allows you to print variable data.

Example 1:

„RADWAG”
 DATE: <current measurement date>
 HOUR: <current measurement time>
 PRODUCT MASS: <current mass indication>

*****SIGNATURE:.....
 <current working mode>

Enter printout content settings and design the printout using respective data variables and characters for text format.

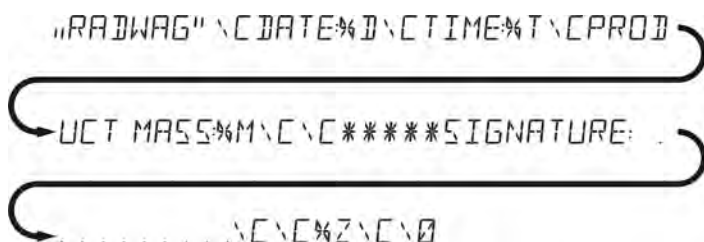

Example 2:

In order to carry out HEADER or GLP or FOOTER printout using EPSON printer (equipped with an auto-cutter blade) and crop the paper beneath the respective printout, select an option of non-standard printout 1, 2, 3 or 4 comprising <%E> variable, and set this option in header, GLP printout or footer settings, respectively.

In such a case <SUFFIX> command must remain empty. Paper is to be cropped underneath the FOOTER.

Exemplary settings:

- P5.4.14NSD. PRN. | NSD. PRN.1
- P5.5 NSD. PRN. 1 |%E

Method for inserting the text:

– using balance display

F2 ▶	Press to select character to be changed. Moving the cursor or an active (blinking) character to the right.
F4 ◀	Press to select character to be changed. Moving the cursor or an active (blinking) character to the left.
F3 ▼	Press to change the character by one value down.
F1 ▲	Press to change the character by one value up.
→0← Delete	Press to delete a character.
→T← Insert	Press to insert a character.

– using computer keyboard of USB type

A computer keyboard of USB type can be connected to a balance, this enables easier and quicker editing of the printouts.

Willing to insert any text, it is necessary to select a respective menu option and, using the keyboard, type the text and press <Enter> key to confirm.

Caution:

It is important to insert non-standard printouts variables using capital letters.

11.4. Variables

Variable is defined as alphanumeric data which can be linked to printouts, products or other information related to weighing. Variables are used for entering various data during the weighing process, e.g. serial number or batch number. The program allows you to enter 2 variables. Each can consist of 32 characters maximum. Every variable is characterized by its content, the content must be inserted.

In order to insert a variable content, you need to enter variable settings (P5.9 – VARIABLE 1 or P5.10 – VARIABLE 2) and insert the respective values using navigation keys of the balance keypad or a computer. Procedure for entering texts is the same as for non-standard printouts.

12. DATABASES

The software features 3 editable databases (OPERATORS, PRODUCTS, TARES) and 2 non-editable databases (WEIGHINGS and ALIBI) to which all measurements carried out using balance are saved.

The range of data that can be stored in each database:

OPERATORS	– 100 records.
PRODUCTS	– 1000 records.
TARES	– 100 records.
WEIGHINGS	– 5 000 records.
ALIBI	– 100 000 records.

12.1. Operators

You can enter the following data for each operator:

NAME (30 characters), **CODE** (6 characters),
PASSWORD (8 characters, only digits),
PERMISSION LEVEL (*OPERATOR, ADVANCED, ADMIN*),
LANGUAGE (each of the languages available in the balance).

Permissions Levels

There are 3 permissions levels: *OPERATOR, ADVANCED, ADMIN*.

Access to operator-related parameters, databases and program functions is conditioned by permissions level.

Permissions levels	Available parameters and functions
OPERATOR	Operator can edit the following submenus: P2.1 AVAILABILITY, INFORMATION and HOT KEYS for each working mode and <MISC.> except for <P6.2 PERM. LVL>, <P6.7 DATE> and <P6.8 TIME>. Operator can preview <Databases> data, and define universal variables. Operator can run and carry out all weighing operations.
ADVANCED	Operator can edit the following submenus: <READOUT>; <WORKING MODES>; <COMMUNICATION>; <PERIPHERALS>; <MISC.>, except for <P6.2 PERM. LVL>, <P6.7 DATE> and <P6.8 TIME>. Operator can run and carry out all weighing operations.
ADMIN	Operator can edit all operator-related parameters and all databases, and use all functions.

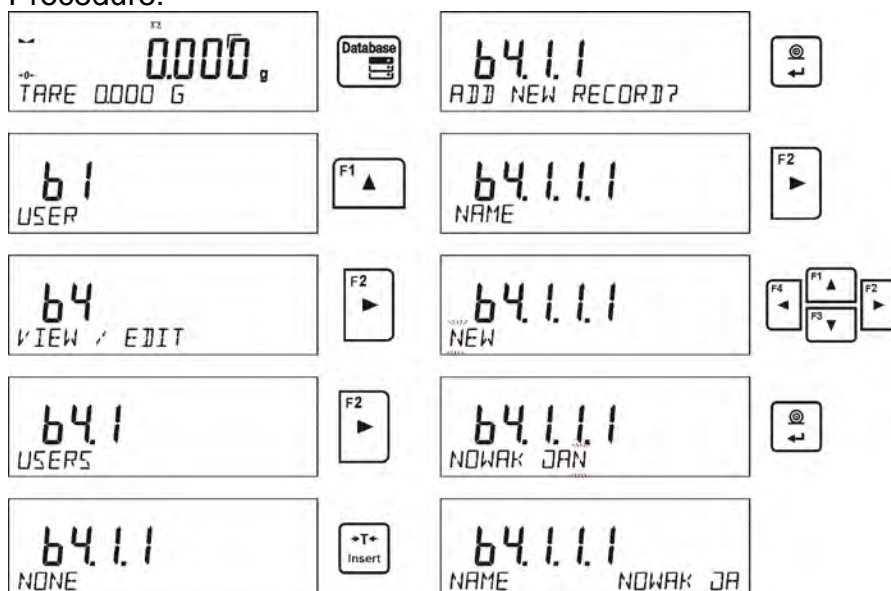

Procedure:



Upon entering operator name, enter the following data:

- operator code – 6 characters maximum,
- operator password – 8 digits maximum,
- operator permissions level – OPERATOR/ADVANCED/ADMIN,
- select menu language for and operator.

To delete an operator:

- Enter operators database.
- Select operator to be deleted from the list.
- Press  key.
- Message <DELETE?> is displayed.
- Press  key to confirm.
- Upon confirmation, the operator is deleted.

Upon balance start-up, the display is active all the time. This enables to carry out mass measurements without logged in operator.

12.2. Products

PRODUCTS database contains 1000 products. You can enter the following data for each product:

- NAME (30 characters),
- CODE (6 characters),
- EAN code (16 characters),
- MASS (in accordance with the reading unit),
- TARE (mass of a packaging of a particular product, in accordance with the reading unit),
- MIN (MIN threshold for <DOSING> mode, must be entered in accordance with the reading unit),
- MAX (MAX threshold for <DOSING> mode, must be entered in accordance with the reading unit),
- TOLERANCE ([% value calculated in relation to mass, the parameter determines measuring range for which the measurement is recognized as correct for <DOSING> mode).

In order to add a product, enter products database and add name to the product (follow the instructions for adding an operator which are presented above). Next, enter all necessary data concerning the product.

12.3. Tares

TARES database contains 100 records of packagings masses. You can enter the following data for each packaging:

- NAME (30 characters),
- TARE (mass of the packaging of a particular product, with the accuracy of reading unit).

In order to add a tare (packaging mass) enter tares databases and add name of a tare (follow the instructions for adding an operator which are presented above). Next, enter all necessary data concerning the packaging.

12.4. Weighings

WEIGHINGS database is a non-editable database, i.e. all data concerning measurements is saved automatically. You can preview, print or export the data to the flash drive (for detailed instruction on exporting the database read further down this user manual).

The software enables saving and storing up to 5000 measurements.

Measurements are saved automatically upon each pressing of the <PRINT> key. There is no need for any additional operations or changing settings.

The following data related with the measurements is saved:

- Date
- Time
- Result (mass)
- Tare value
- Product name
- Logged in operator carrying out the measurement
- Working mode
- 1 and 2 variables

The software saves the measurement in a so called loop, i.e. when the measurement no. 5001 is saved, the measurement 1 gets automatically deleted from the balance memory.



Measurements saved to balance memory cannot be deleted.

You can preview and print out the data saved to the WEIGHINGS database.

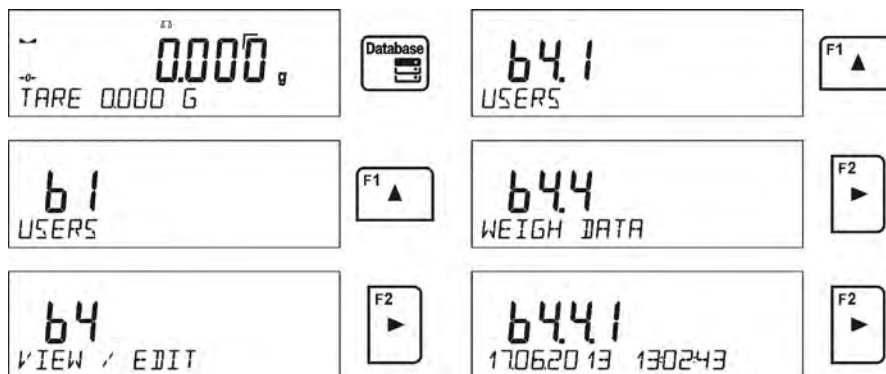
Procedure:



Each measurement features an individual number which is also its name. Number format: b4.4.n; where <n> is the subsequent number of saved measurement. Each measurement contains its date and time that are displayed in the bottom line.



To move between saved measurements, press one of the following keys:  or . Each pressing of the keys causes selecting next or previous measurement.

To view measurement data, select the measurement and press .

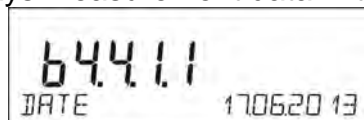

The software automatically displays measurement data in the bottom line.



Each pressing of the following keys:  or  changes the measurement data that are displayed (bottom line). Measurement data is printed out upon selecting <PRINT> option and pressing  key.

An exemplary printout of selected record:

```

Date      21.06.2013
Time      13:05:02
Operator
Product

Tare      0.000 g
Gross     0.000 g
          0.000 g
-----Adj. Report-----
Adj. type Internal
Operator
    
```

Project 1234567890123459
 Date 16.07.2013
 Time 13:27:09
 Balance S/N 10353870
 Adj.Differ -0.004 g

 Signature

.....
 Data to be printed is to be set in P5.3 GLP PRNT. parameter. Data with <YES> value selected is to be printed out. This also applies to printouts in <WEIGHINGS> database (read section 8.2.)

12.5. ALIBI Memory

The module is equipped with ALIBI memory that enables saving and storing up to 100 000 carried out measurements.

Measurements are saved automatically upon each pressing of the <PRINT> key. There is no need for any additional operations or changing settings.

The following data related with the measurements is saved:

- Date
- Time
- Result (mass)
- Tare value
- Logged in operator carrying out the measurement
- Product name

The software saves the measurement in a so called loop, i.e. when the measurement no. 100 001 is saved, the measurement 1 gets automatically deleted from the module memory.

Measurements saved to balance memory cannot be deleted.

You can preview and print out the data saved to the ALIBI database.

Procedure:

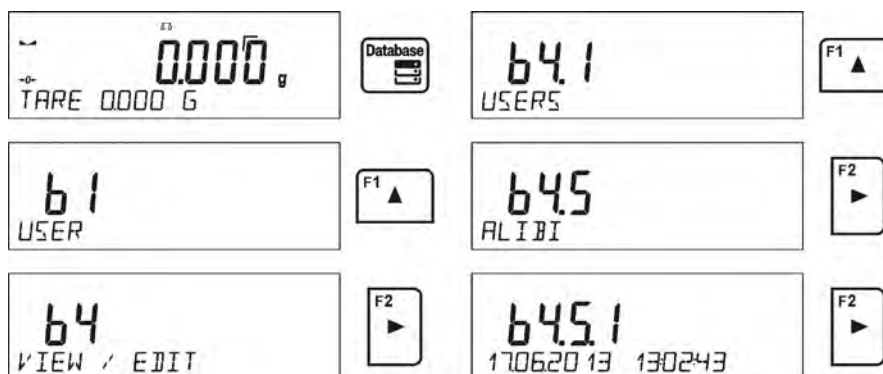

Each measurement features an individual number which is also its name. Number format: b4.5.n; where <n> is the subsequent number of saved measurement. Each measurement contains its date and time that are displayed in the bottom line.

Any operations carried out in ALIBI memory are performed in the same way as described above for the weighings database.

An exemplary printout of selected record:

Date 19.06.2013
Time 6:48:41
Result 199.90 g
Tare 0.000 g
Operator NOWAK
Product PILL

Press  key repeatedly to return to weighing.

13. WORKING MODES

- Weighing
- Parts counting
- Checkweighing
- Dosing
- Percent weighing against reference sample mass
- Solids density determination
- Liquids density determination
- Animal weighing
- Statistics
- Totalizing
- Peak hold
- Pipettes calibration (MAS series)

To run particular working mode, press  key and select mode from the list.



Upon pressing  key name of the first function is displayed.

 or  - working mode selection.

 - entering selected working mode.

Caution:

The balance is restarted with the last working mode activated.

For detailed overview of the working modes read further down this user manual.

13.1. Working Modes Availability

This group of parameters allows you to declare which functions are to be accessible upon pressing  key. You can deactivate functions that are not used in the course of balance operation, to do it, set the availability parameter to **<NO>** value.

Procedure:

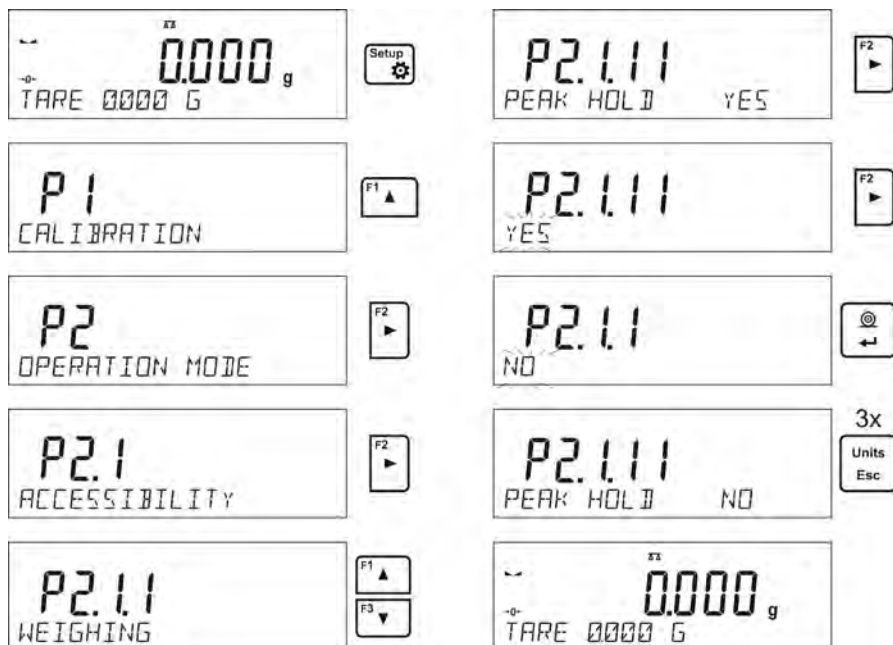

13.2. Weighing

13.2.1. Good Weighing Practice

In order to assure a long-term device operation, wherein correct measurements are provided, the following principles must be adhered to:

- Start the balance with no load on the weighing pan (permissible value of load on the weighing pan at start is $\pm 10\%$ of the maximum capacity).
- Load the weighing pan steadily avoiding shocks:

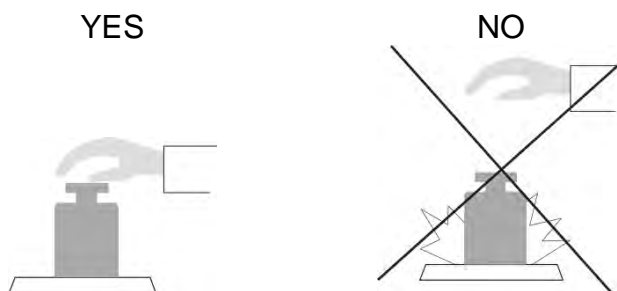

- Place weighed loads centrally on the weighing pan.



- Avoid side loading, in particular side shocks:

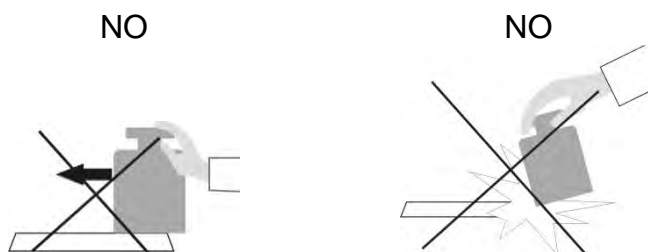

Prior the measurement and in case of ambient conditions changes, adjustment has to be carried out.

- Prior the measurement it is recommended to load the weighing pan several times with mass close to the maximum capacity,
- upon unloading the weighing pan make sure the weighing instrument indicates zero $\rightarrow 0 \leftarrow$ pictogram and the measurement is stable - $\blacktriangle\blacktriangle$ pictogram; if not, press $\rightarrow 0 \leftarrow$ / **Delete** key,
- press **UNITS** key to select the unit,
- load the weighing pan. Upon stabilization you can read the result.
- mass of the load on the weighing pan can be tared multiple times. To do that, press $\rightarrow T \leftarrow$ / **Insert** key (make sure that the sum of tared masses is not greater than maximum capacity).

Do not unplug the weighing instrument from the mains between measurements. It is recommended to disable the display by pressing **ON/OFF** key. Press **ON/OFF** key again, the weighing instrument is ready to carry out next measurements.

13.2.2. Zeroing

To zero mass indication press  key. Zero indication and the following pictograms are displayed: $\rightarrow 0 \leftarrow$ and $\blacktriangle\blacktriangle$. Zeroing operation means determining new zero point, recognized by the weighing instrument as precise zero. The instrument can be zeroed only when the indication is stable.

Caution:

*Indication can be zeroed only within $\pm 2\%$ range of maximum capacity. If the zeroed value is above $\pm 2\%$ of the maximum capacity, then the software indicates a respective **Err2** error message.*

13.2.3. Taring

To determine net weight value, load the weighing pan with a packaging, wait for a stable indication and press  key. Zero indication and the following pictograms are displayed: **Net** and $\blacktriangle\blacktriangle$.

Upon unloading the weighing pan, the sum of tared masses with minus sign is displayed. You can assign tare value to a particular product stored in the database. In such case the assigned tare value is automatically acquired upon selection of the given product.

Caution:

It is impossible to tare negative values. When you try to tare negative values, the weighing instrument responds with **Err3** message.

In such case, zero the indication and repeat taring procedure.



Entering tare value manually

Procedure:



- Press **F** quick access key to which <ENTER TARE> option is assigned (for detailed instruction on how to set quick access key read section *F Quick Access Keys*).
- Enter the tare value using navigation keys and press  key.
- Balance returns to weighing mode. Tare value with „-“ sign is displayed.

Selecting tare value out of TARES database

Procedure:

- Press  or **F** quick access key to which <ENTER TARE> option is assigned (for detailed instruction on how to set quick access key read section *F Quick Access Keys* or select <ENTER TARE> option).
- The first packaging mass saved to tares database is displayed. Using navigation keys select respective tare and press  key.
- Balance returns to weighing mode. Tare value with „-“ sign is displayed.

or

- Press  key.
- Enter b3 <TARE> database.
- The first packaging mass saved to tares database is displayed. Using navigation keys select respective tare and press  key.
- Balance returns to weighing mode. Tare value with „-“ sign is displayed.

Deleting tare

The entered tare value can be deleted by pressing  key located on the operation panel, or by entering value of 0.000g (read the above description).

13.2.4. Weighing Profiles

To simplify weighing instrument operation, there are 4 profiles in the software. The profiles are selected and saved so that the weighings for respective requirements and conditions are optimized.

Profile settings apply to settings for specific working mode and are grouped in the following parameter: *Setup/Working modes/Weighing/Readout*.

For detailed description of these settings go to the next section of this user manual.

These are the following profiles:

- **User** – the basic profile for which filter settings are selected in a way enabling fast and precise weighing.
- **Fast** – profile enabling weighing of any mass regardless of the working mode. When running the balance for the first time, this profile is started automatically. For this

profile the parameters are selected in a way enabling obtaining the measurement result as fast as it is possible,

- **Fast dosing** – the profile is dedicated for fast dosing.
- **Precision** – the profile is dedicated for precise dosing of any mass regardless of the working mode. For this profile the weighing process takes the most time, but the result is the most accurate and precise,

Caution: You can modify all settings of User profile. Settings of other profiles (Fast, Fast dosing and Precision) can be modified only to a limited extend.

Name of currently selected profile is displayed in the bottom line. The profile can be selected individually for working mode. The balance saves the last used profile in each working mode (with your modifications) and starts operation with that profile selected.

Procedure:

- * In any working mode press **F** quick access key to which **<PROFILE>** option is ascribed (for detailed instruction on how to ascribe quick access keys, refer to *F Shortcut keys* section of this user manual) or select **<PROFILE>** option upon

pressing  key.

- * Using navigating keys, select profile and press  key.

- * The balance returns to weighing mode and operates in accordance with set profile.



13.2.4. <WEIGHING> Mode Settings - Readout

The software allows setup of operating parameters (filters, value release and autozero function, deleting the last digit and other settings) separately for each working mode.

It enables customizing the instrument and utilizing its properties depending on your needs and expectations, or on specific requirements for selected working mode (e.g. DOSING); as a result the device operation is quick and easy.

Setting filter level

Filter settings depend on the working environment. For the best possible conditions the filter can work in a very fast mode (V. FAST value for P.2.2.1.1 parameter); however, if the conditions are poor (shakes, drafts), the filter should be set to slow or very slow option (SLOW or V. SLOW value for P.2.2.1.1 parameter). The effectiveness of the filter is different throughout the weighing range. The filter works slower when the weight value of weighed mass is about to be determined, it works more intensively when the weighed mass is within the set range of the filter (parameter for setting filter range is accessible only from the service menu – the operator does not have any access to it).

Depending on the selected option, weighing time is either shorter (V. FAST and FAST) or longer (SLOW and V. SLOW).



Value Release

Since ambient conditions at a workplace vary, it is necessary to determine the value release parameter in the most preferable way enabling weighing instrument adaptation, parameter options are: **FAST+REL.**, **FAST** or **RELIABLE**. Depending on the selected option, weighing time is either shorter or longer.

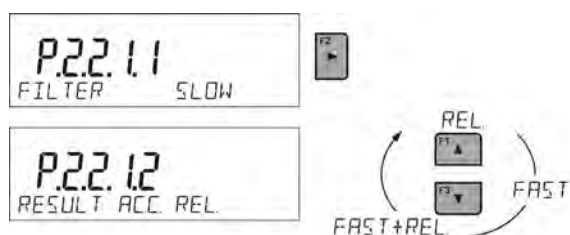

Autozero function

The software offers an autozero function (**Auto**) ensuring precise mass indication. The function has been designed to enable automatic control and correction of zero indication. If the function is enabled, the subsequent measurement results are compared to each other in constant time intervals, e.g. every 1 s; when the weighing pan is unloaded and the indication is close to zero. If the results differ less than declared AUTOZERO range, e.g. 1 division, the balance is automatically zeroed, and the pictograms of stable indication – **▲▲** and precise zero – **-0-** are displayed.

Active Autozero function means, that each measurement starts with the precise zero. There are, however, some cases when this function can be a disturbing factor for the measuring process, e.g. very slow placing of a load on the weighing pan (load adding).

In such case, the system correcting zero indication may also correct the indication of actual weight of load placed on the weighing pan.

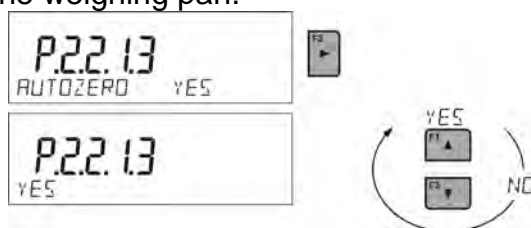

Last digit display

Function enables deleting the last digit on the display.



Balance ambient conditions

Available values: STABLE and UNSTABLE. Setting STABLE value makes the weighing instrument work much faster; i.e. weighing takes much less time than in case of setting the parameter to UNSTABLE value. Parameter relating to ambient and environmental conditions of the workstation. Enter <AMBIENT CONDITIONS> parameter and set <UNSTABLE> value if the ambient conditions are unfavourable (air drafts, vibrations). <UNSTABLE>. By default the parameter is set to value: <STABLE>.

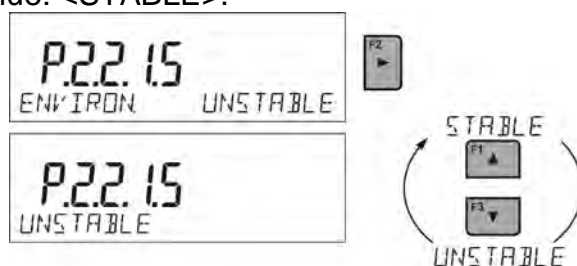

13.2.5. AUTOTARE

Autotare function allows you to quickly determine net weight for loads with different tare values, which loads are measured one after another.

When autotare is enabled (<P2.2.2 AUTOTARE> parameter set to <YES> value), operation takes the following order:

- Make sure that the weighing pan is empty and press zeroing key.
- Load the packaging.
- Upon indication stabilization, packaging mass is **automatically tared** (**Net** pictogram is displayed in the upper part of the display).
- Put/pour/dispense product that is to be packed into the packaging.
- Unload the weighing pan (remove both product and packaging).
- When the weighing instrument detects weight value lower than gross weight value set in < **P 2.2.3.2 AUTO THRES.**> parameter, the entered tare value is automatically deleted (**Net** pictogram is no longer displayed).
- Load the weighing pan with packaging of another product, upon indication stabilization, packaging mass is automatically tared (**Net** pictogram is displayed in the upper part of the display).
- Put/pour/dispense product that is to be packed into the packaging.

For correct operation of the weighing instrument with AUTOTARE function, it is necessary to adjust the threshold value.

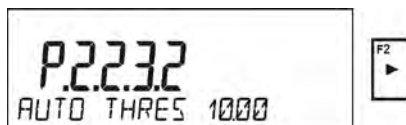

<P 2.2.3.2 AUTO THRES.> parameter refers to the following functions:



- autotare,
- operation performed automatically.

No automatic taring takes place as long as the gross weight value stays within the range set in < **P 2.2.3.2 AUTO THRES.**> parameter.

13.2.6. Print Mode

Function designed to enable print mode setting; it activates  key.

Available values:

- <WHEN STB.>: for this value stable measurement result, along with the settings for <GLP PRNT> parameter, is sent to the printer port. Upon pressing  key at the moment when the result is unstable (no  pictogram displayed), the program first waits for the stability condition to be met, next sends the measurement result to the port.
- <EACH>: every single pressing of  key results with sending the measurement indication to the printer port along with the settings for <GLP PRNT> parameter. Every single indication is sent (stable and unstable). In case of unstable indication, <?> sign is displayed in front of the weighing result frame. **Function available for non-verified balances exclusively.**
- <AUTO>: select this value to enable automatic printout. When selecting <AUTO> value remember to set <AUTO THRES> in accordance with your requirements.
- <AUTO + INT.>: select this value to start automatic printout and record of indications in WEIGHINGS and ALIBI databases, carried out in a cyclic manner in a specified time intervals. The interval is set in [min] in P2.2.3.3 <AUTO INT.> parameter. Interval range is 1 - 9999 min.

For automatic operation with an interval, set its value in [min].

The figure below shows the interval value set to 2 minutes.

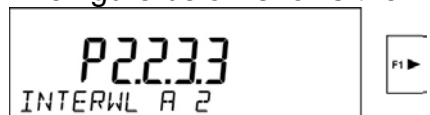



Caution:

Each weighing result is printed and recorded: stable (verified instrument) and unstable (for non-verified instrument).

Automatic operation with interval starts at the moment of switching the function on and remains active until it is switched off.

Upon switching the function of auto print with interval on, PRINT button becomes inoperative (no indication is printed when pressed).

Automatic operation procedure:

- Press  key to zero the indication (stability marker , and zero pictogram  are displayed).
- Load the weighing pan, the first stable measurement is sent to the printer port.
- Unload the weighing pan.
- The next measurement is possible when the indication gets lower than the value set for <AUTO THRESHOLD> parameter (next measurement does not require zero value).

Settings modification:

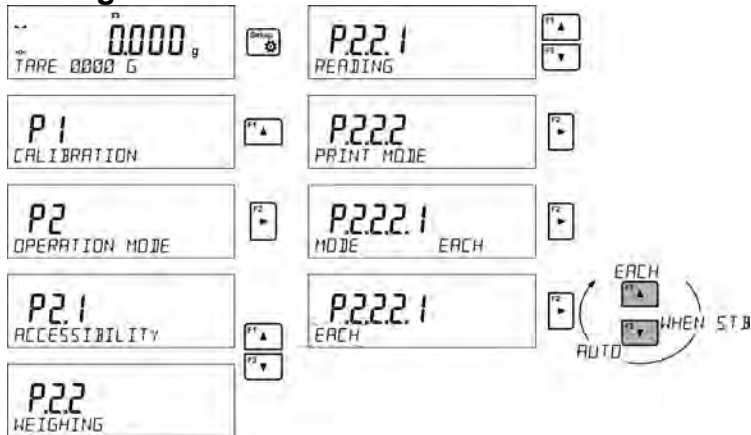

For automatic operation it is necessary to adjust the threshold value.

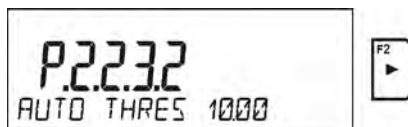

13.2.7. Information

Function enables displaying additional information in the bottom part of the display. You can choose between the following information that is to be displayed during <WEIGHING> mode operation:

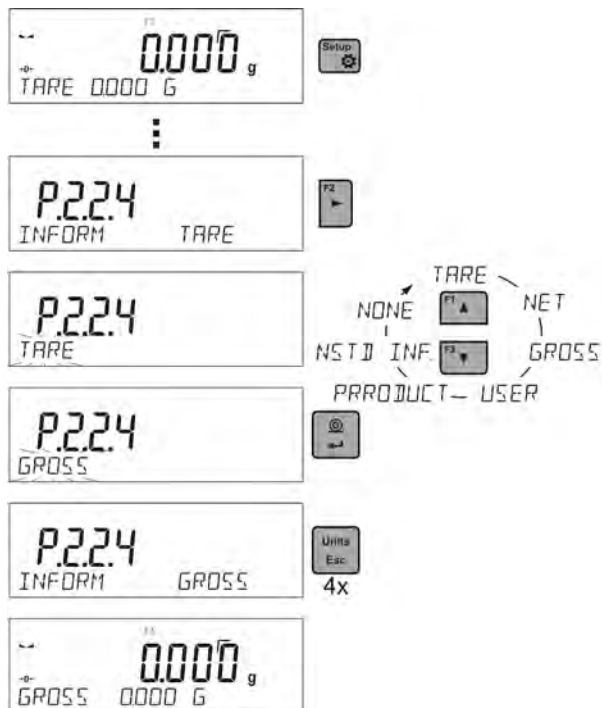

<BAR GRAPH> is a graphic visualisation informing you how much of the weighing instrument capacity is used. It allows you to observe whether the load stays within the specified Max capacity or is out of it.



In the above figure you can see an exemplary display of PS 1000.R2 weighing instrument with enables <BAR GRAPH> option: the weighing pan is loaded with 500g mass which is 50% of the max capacity (the bar graph is half-filled).

<BAR GRAPH> option can be enabled for the following modes: PARTS COUNTING, CHECKWEIGHING, DOSING, PERCENT WEIGHING, ANIMAL WEIGHING, STATISTICS, TOTALIZING, PEAK HOLD.

13.2.8. Non-standard Information

Function enables declaring non-standard information to be displayed in the bottom part of the display. You can declare any text which can consist of 19 characters maximum.

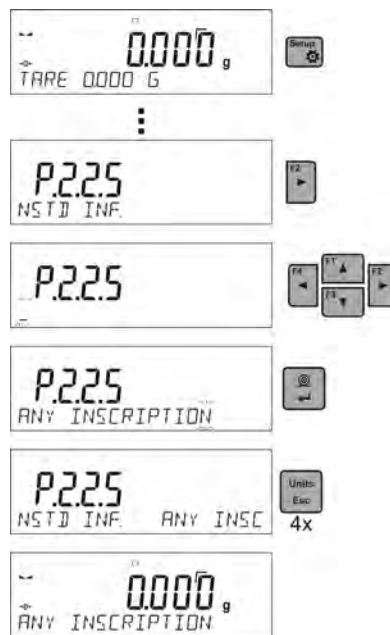

Remember to enable the non-standard information by setting **P2.1.2** option to <**NSTD INF.**> value.

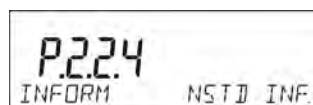

13.2.9. F Quick Access Keys

Function enables assigning quick access for weighing functions which are to be accessible by pressing F1, F2, F3 or F4 keys. You can choose between the following options for <**WEIGHING**> mode: <NONE / ENTER TARE / PRINT HEADER / PRINT FOOTER / VARIABLE 1 / VARIABLE 2>. These options can be freely assigned to any of the **F** keys. For other modes there are more available options (read: further sections of this user manual).

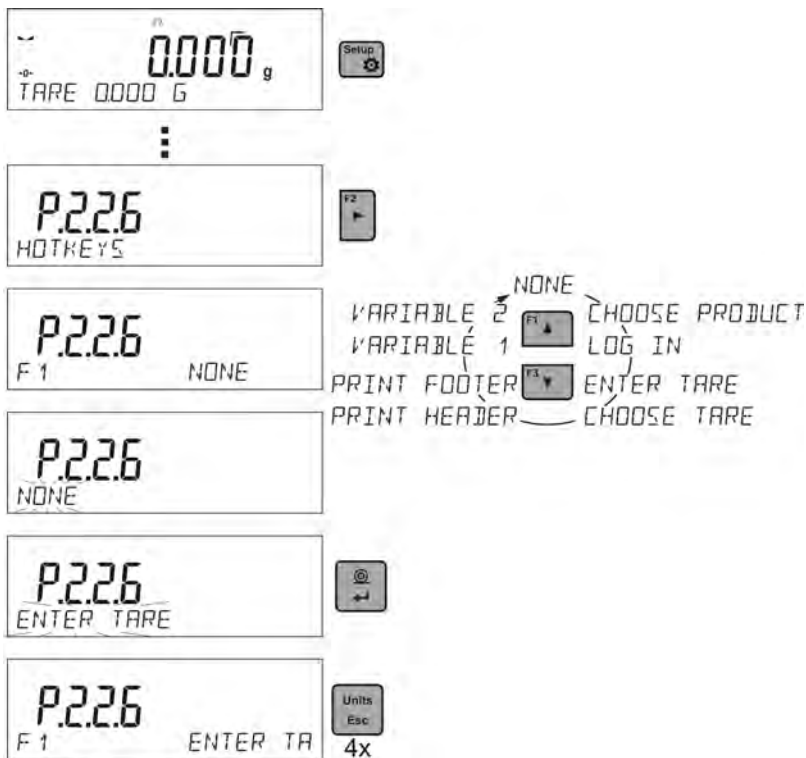

Functions for particular working modes:

Function	Modes featuring the function
SELECT PRODUCT	All modes
LOG IN	All modes
ENTER TARE	All modes
SELECT TARE	All modes
PRINT HEADER	All modes
PRINT FOOTER	All modes
VARIABLE 1	All modes
VARIABLE 2	All modes
ON/OFF LAST DIGIT	All modes except for Parts Counting and Percent Weighing
ENTER SAMPLE	Parts Counting, Dosing, Percent Weighing
DETERMINE SAMPLE	Parts Counting, Percent Weighing
SET HI_LO	Checkweighing exclusively
START	Animal Weighing, Solids Density, Liquids Density, Pipettes Calibration
RESULT	Statistics, Totalizing
END	Statistics, Totalizing, Basic Totalizing
DELETE LAST.	Totalizing, Basic Totalizing

13.2.10. Under-Pan Weighing

Standard balances and scales feature option of under-pan weighing. Such means of operation requires placing a balance in an uplifted position. RADWAG offers a rack for under-pan weighing.

For under-pan weighing follow below procedure:

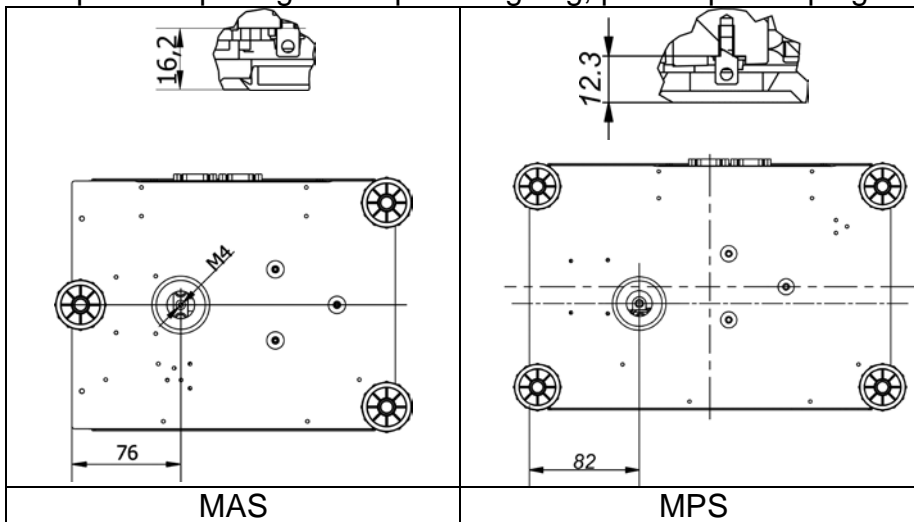

- * remove plastic hole plug located in the module base,
- * under the plug you can find a special holder with an opening dedicated for suspending the load (fixed permanently),
- * the opening is used for fixing a hook intended for either load or a dedicated weighing pan, once depositing a load one can start weighing,
- * upon completing under-pan weighing, put the plastic plug back onto its place.



Caution:



Be careful so as not to cause any damages to the balance mechanism. The suspension for hook must not be turned, twisted or manipulated in any direction. Such actions may cause damage to module mechanism.

Mass of all additional elements of under pan weighing kit, like the hook, weighing pan, string, etc. should be zeroed by pressing  or  keys on the operator's panel or by sending a respective command <Z> or <T> using computer.

13.3. Counting Parts of the Same Mass

Standard balance is equipped with option of counting parts of the same mass.

For first enabling of the function the mass standard's weight is 0.0000g. If the mass standard is determined or entered and used during parts counting, then during subsequent entering into <PARTS COUNTING> mode the software will set mass of the last standard as the mass standard value.

13.3.1. Parts Counting Settings

The software allows you to determine respective settings for each working mode. Some of the settings are identical for all modes. The settings are described in <WEIGHING> section of this user manual.

In this section, only settings for <PARTS CNT.> mode are described.

F Quick Access Keys

Function enables assigning quick access functions which are to be accessible by pressing F1, F2, F3 or F4 keys.

For procedure informing you how to declare the particular function, read *F Quick Access Keys* section.

13.3.2. Setting Reference Sample Mass Using Sample of Known Quantity

During determination of single part mass **ACAI** (Automatic Accuracy Correction of part mass) function is used.



Means of operation of ACAI function:

- parts quantity upon adding must increase,
- parts quantity upon adding cannot increase more than twice,
- parts quantity upon adding must be comprised within ± 0.3 tolerance of total value,
- the weighing result must be stable.

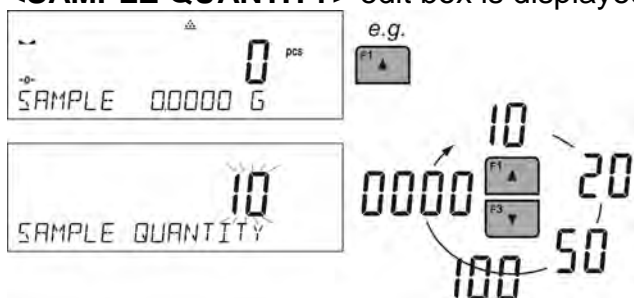

Procedure:

- Put the container on a weighing pan and tare it.
- Press **F** quick access key to which **<DETERMINE SAMPLE>** function is assigned, **<SAMPLE QUANTITY>** edit box is displayed.



- Using  and  keys select sample quantity.
- For option: any quantity (displayed value: **<0000>**) enter any number using navigation keys.
- Confirm selected sample quantity, the following message is displayed: **<PUT xx PRTS>**.



- Load the weighing pan with declared amount of parts. When the indication is stable ( pictogram is displayed), press  key to confirm the mass.
- Single part mass is calculated automatically, **<PARTS COUNTING>** working mode runs and the weighing instrument displays quantity of single parts (**prts**), and in the bottom line - single part mass value (if such option is selected for **<INFORM.>** option).





Caution:

Remember:

- Total weight value of all parts loaded onto the weighing pan cannot be greater

than the maximum capacity value.

- Single part mass must be equal or greater than **0.1 reading unit**. Unless this condition is met, the weighing instrument displays a message: **<Single part mass too low>**.
- During parts counting determination wait until  pictogram is displayed.
- Next, confirm declared quantity of parts by pressing  key. Otherwise, the balance does not accept the measurement.

13.3.3. Setting Reference Sample Mass by Entering Mass of a Single Part

Procedure:

- Press **F** quick access key to which **<ENTER SAMPLE>** function is assigned, **<ENTER SAMPLE>** edit box is displayed.

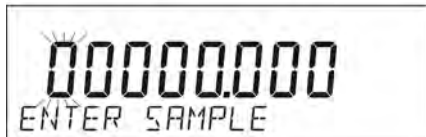
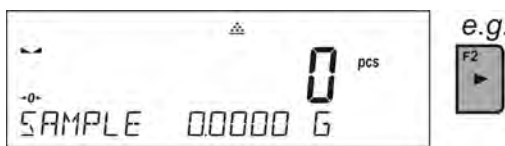

- Enter known mass of a single part using navigation keys.



- The software automatically enters **<PARTS COUNTING>** working mode and the weighing instrument displays quantity of single parts (**prts**), and in the bottom line - single part mass value (if such option is selected for **<INFORM.>** function).

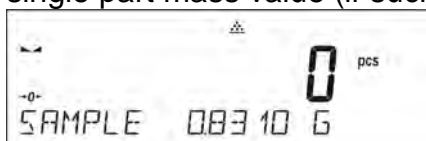

13.4. Checkweighing

< Checkweighing > is a working mode using two thresholds (Min and Max) for control of samples weight. Usually the weight is considered to be correct if it is comprised within threshold values.

F Quick Access Keys

Function enables assigning quick access functions which are to be accessible by pressing F1, F2, F3 or F4 keys.

For procedure informing you how to declare the particular function, read *F Quick Access Keys* section.

13.4.1. Declaring Checkweighing Thresholds







Procedure:

- Press **F** quick access key to which **<Set HI_LO>** function is assigned, edit box for entering MIN threshold is displayed. Threshold value has to be entered in a current unit.



- Using navigation keys enter minimum threshold value and press  key to confirm.
- The software automatically proceeds to MAX threshold editing. Threshold value has to be entered in a current unit.

- Using navigation keys enter maximum threshold value and press  key to confirm.
- The software automatically enters **<CHECKWEIGHING>** working mode and displays in the bottom line values of declared thresholds – (if such option is selected for **<INFORM.>** function).
- In the upper part of the display, message **<Min>** is displayed, it signals the current status of mass on the weighing pan in comparison with MIN threshold value; in the bottom part, for selected **<BAR GRAPH>** option, mass value will be signalled graphically in accordance with set thresholds.

	
<Min> : mass lower than MIN threshold value	
	
<Ok> : mass value higher than MIN value and lower than MAX value,	
	
<Max> : mass greater than MAX threshold value	

Due to the limited capabilities of LCD display, these symbols do not accurately reflect thresholds settings and target mass, but are meant to visualize settings as a help for operator-balance operation.

13.5. Dosing

Dosing is a working mode that facilitates dispensing process, wherein the dispensing takes as long as it is necessary to obtain a pre-defined target weight. Target mass is declared along with dosing tolerance. Tolerance value is set as the percent of target mass, by entering value expressed in percent.

Example:

Target mass = 100.000g

Tolerance = 2.5% (2.5% of 100g which is: 2.5g);

i.e.: correct value ranges between 97.500g and 102.500g.

F Quick Access Keys

Function enables assigning quick access functions which are to be accessible by pressing F1, F2, F3 or F4 keys.

For procedure informing you how to declare the particular function, read *F Quick Access Keys* section.

13.5.1. Setting Target Mass by Entering its Value

Procedure:

- Press **F** quick access key to which **<ENTER SAMPLE>** function is assigned, **<ENTER SAMPLE>** edit box is displayed. Target mass value has to be entered in a current unit.

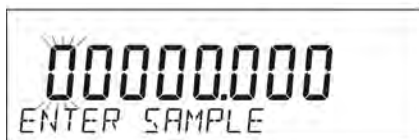

- Using navigation keys enter known target mass value and press  key to confirm.
- The software automatically proceeds to tolerance settings for target mass dosing.

Using navigation keys set tolerance value and press  key to confirm.

- The software automatically enters **<DOSING>** working mode and displays target mass value with minus sign, and in the bottom line - reference sample mass which is target mass (if such option is selected for **<INFORM.>** function).



- In the upper part of the display, message **<Min>** is displayed, it signals the current status of mass on the weighing pan in comparison with target mass, below **<TARGET MASS - TOLERANCE>** value; in the bottom part, for selected **<BAR GRAPH>** option, mass value will be signalled graphically in accordance with target mass and set tolerance:

<p><Min>: mass value lower than 'target value - tolerance value',</p>		
<p><Ok>: mass value within permissible tolerance range: Target value +/- Tolerance value.</p>		
<p><Max>: mass value greater than 'target value + tolerance value'</p>		

Due to the limited capabilities of LCD display, these symbols do not accurately reflect thresholds settings and target mass, but are meant to visualize settings as a help for user-balance operation.

13.6. Percent Weighing Against Reference Sample Mass

Percent weighing is a working mode enabling you to compare the measured sample with the reference mass. The result is expressed in [%]. Reference mass can be either determined by weighing or entered to weighing instrument memory by an operator.

F Quick Access Keys

Function enables assigning quick access functions which are to be accessible by pressing F1, F2, F3 or F4 keys.

For procedure informing you how to declare the particular function, read *F Quick Access Keys* section.

13.6.1. Setting Reference Sample Mass by Weighing

Procedure:

- Press **F** quick access key to which **<DETERMINE SAMPLE>**, **<PUT 100%>** edit box is displayed.



- Load the weighing pan with reference sample (which presents 100%). When the indication is stable (▲ pictogram is displayed) press  key to confirm,



- The software automatically enters value of measured load as the reference sample value and proceeds to **<PERCENT WEIGHING>** working mode. The software displays 100.000%, and in the bottom line – reference sample value (if such option is selected for **<INFORM.>** function).



13.6.2. Setting Reference Mass by Entering

Procedure:

- Press **F** quick access key to which **<ENTER SAMPLE>** function is assigned, **<ENTER SAMPLE>** edit box is displayed.

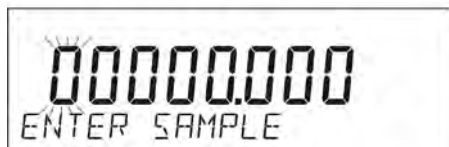
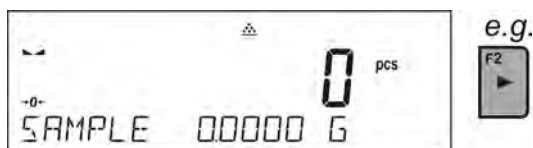

- Using navigation keys enter known reference mass value and press  key to confirm.
- The software automatically enters **<PERCENT WEIGHING>** working mode and displays 0.000%, and in the bottom line – entered value of reference sample mass (if such option is selected for **<INFORM.>** function).

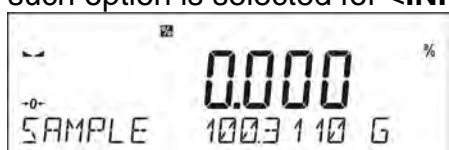

13.7. Animal Weighing

<Animal weighing> is a working mode allowing reliable determination of mass of weighed objects in motion. In principle, this type of objects generate unstable measurement, thus it requires using a different filtering method of measurement signal.

13.7.1. Additional Settings for Animal Weighing

Apart from standard settings for this mode (described in the weighing mode section), additional parameters have been introduced concerning working mode operation.

Parameters:

- **AVER. TIME** - Time interval within which measurements are analysed. Obtained data is used for calculation of average measurement result.
- **THRESHOLD** - Value expressed in mass units. In order to trigger the measurement, the indicated value has to be greater than the threshold value.
- **AUTOSTART** - Parameter determining whether the measurement is to be carried out manually: upon pressing key selecting START function, or automatically. With **<YES>** value selected, the measurement starts when the set threshold value is exceeded. The next object is measured when the previous object is removed from the weighing pan (the indication is below threshold value) and the weighing pan is loaded with next object and the indication exceeds the set threshold value.

Remember to set the above options to respective values in accordance with needs and requirements (resulting from operation conditions) prior animal weighing.

F Quick Access Keys

Function enables assigning quick access functions which are to be accessible by pressing F1, F2, F3 or F4 keys.

For procedure informing you how to declare the particular function, read *F Quick Access Keys* section.

13.7.2. Manual Weighing

To start manual weighing, select <AUTOSTART> option and <NO> value.

Procedure:



After changing the setting, return to the home screen by pressing  key repeatedly. Next, set averaging time in seconds. This is the time interval within which the software collects measurements which are then used to calculate average measurement result. <THRESHOLD> parameter is not required for this measurement.

Next, select <ANIMAL WEIGHING> working mode.

Put the container used for carrying out the measurement on a weighing pan and tare it when it is stable.

Next, enter mode options and start measurement procedure. Follow the instructions presented below.

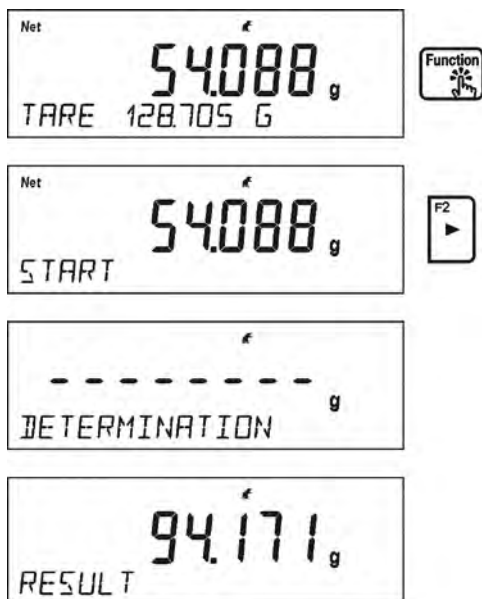

Upon measurement completion, the result is snapped and printed out.

Press  key to finish the measurement. Home screen of the main mode is displayed automatically.

13.7.3. Automatic Weighing

To start automatic weighing, select <AUTOSTART> option and <YES> value.

Set <AVER. TIME> and <THRESHOLD> parameters.

To carry out weighing using container (TARE) in this working mode, select <ENTER TARE> parameter which is described in options concerning weighing.

To begin the process, enter mass of the container, put the container onto the weighing pan and place object to be weight inside it. Upon exceeding the set mass threshold value, the module automatically starts weighing process.

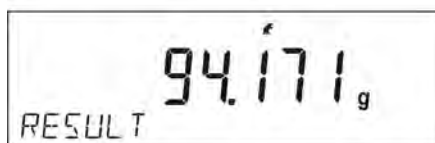
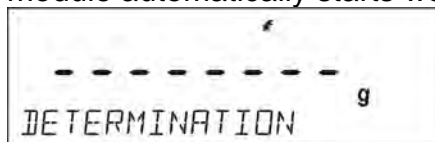

Upon measurement completion, the result is snapped and printed out.

Press  key to finish the measurement. Home screen of the main mode is displayed automatically.

13.8. Solids Density

<Solids density> is a working mode enabling determination of density of a representative sample material.

In order to operate this mode, a density determination kit (supplementary equipment) is required.

F Quick Access Keys

Function enables assigning quick access functions which are to be accessible by pressing F1, F2, F3 or F4 keys.

For procedure informing you how to declare the particular function, read *F Quick Access Keys* section.

13.8.1. Density Measurement

Solids density can be determined using two liquids determined in the balance or in the liquid of known density:

- **WATER** (distilled water),
- **ETHANOL** (ethyl alcohol 100% +/- 0.1% at reference temperature 20⁰C),
- **OTHER** (other liquid of known density).

In case of distilled water and ethyl alcohol you have to enter liquid temperature. For other liquid of known density, the density value is entered using balance keypad. Determination of density for a particular solid is based on weighing the solid in the air first, and in the liquid next. Upon completed procedure the result is displayed automatically.

Procedure:

1. Install density determination kit.
2. Enter <SOLIDS DENS> function.
3. Prepare sample that is to be measured.
4. Start process.



5. Enter process settings. Follow the displayed messages.
6. Select liquid type intended for the test performance.

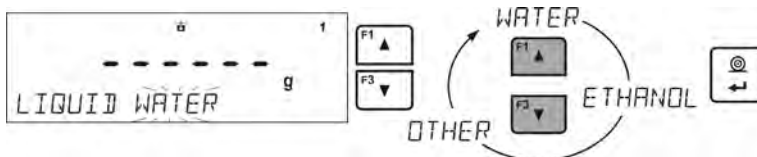

7. Upon selecting the liquid and pressing <ENTER> key to confirm, the software proceeds to next step. Set liquid temperature.



8. If liquid assigned to <MISC.> parameter is used, enter its density for the entered measurement temperature.



9. Measurement process starts.
10. Put your sample on a top weighing pan (sample weight measurement carried out in the air), wait for a stable indication and confirm.

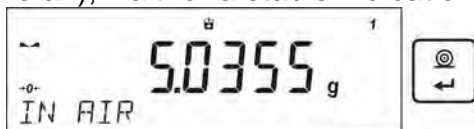

11. Now put your sample on a bottom weighing pan (sample weight measurement carried out in the liquid), wait for a stable indication and confirm.

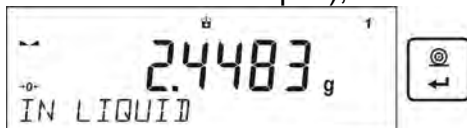

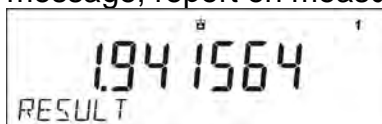

12. Upon confirmation of the second indication, the program automatically calculates measured object density, which is next displayed together with a respective message, report on measurement is sent to a selected printer port.



Exemplary report:

-----Solids Dens-----	
Date	27.08.2013
Time	13:34:50
Balance ID	32100000
User	ADMIN
Liquid	Water
Temp.	23.0 °C
Liquid Dens	0.99756 g/cm ³
In Air	5.0363 g
In Liquid	2.4489 g
Density	1.941722 g/cm ³

Signature	
.....	

The report can be printed repeatedly upon pressing  key. Press  key to finish the process. Home screen of the Density Determination mode is displayed. The next measurement can be started now. The balance operates with previously entered settings (liquid, temperature) thus providing quicker start of the measurement.

13.9. Liquid Density

Liquids density is a working mode enabling determination of density of liquid. In order to operate this mode, a density determination kit (supplementary equipment) is required. It is the same kit as in case of solids density determination (description above). Quick access keys settings are identical as for <SOLIDS DENS.> function (read previous section).

13.9.1. Density Measurement

Glass-made sinker of known volume is a basic equipment used in the course of liquid density determination. Its volume is precisely determined and given on the hook. Prior density measurement, enter the sinker volume value into the weighing instrument memory. Determination of particular liquid density is based on weighing the glass-made sinker in the air first, and in the tested liquid next. Upon completed procedure the result is displayed automatically.

Procedure:

1. Install density determination kit.
2. Enter <LIQUIDS DENSITY> function.
3. Prepare sample that is to be measured.
4. Start process.
5. Enter process settings. Follow the displayed messages.
6. Enter volume of the sinker used for measurement.



7. Measurement process starts.
8. Hang the sinker on a stand (sinker weight measurement carried out in the air), wait for a stable indication and confirm the measurement.



9. Now take the sinker out of the stand and put a beaker on the beaker basis (the beaker cannot be in contact with the stand), gently hang the sinker on the stand making sure that it is completely immersed in the liquid (measurement carried out in the liquid), wait for a stable indication and confirm the measurement.





10. Upon confirmation of the second indication, the program automatically calculates measured liquid density, which is next displayed together with a respective message, report on measurement is sent to a selected printer port.

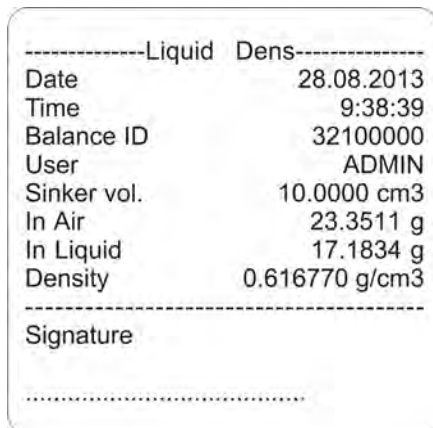

Exemplary report:



The report can be printed repeatedly upon pressing  key. Press  key to finish the process.

Home screen of the Density Determination mode is displayed. The next measurement can be started now. The balance operates with previously entered settings (sinker volume) thus providing quicker start of the measurement.

13.10. Statistics

Statistics is a working mode allowing to acquire data from series of measurements and to produce statistics using the acquired data. Settings of this function determine which data is displayed.

F Quick Access Keys

Function enables assigning quick access functions which are to be accessible by pressing F1, F2, F3 or F4 keys.

For procedure informing you how to declare the particular function, read *F Quick Access Keys* section.

Statistics for each series of measurements:

- N (samples quantity)
- Sum (total weight of samples)
- AVG (average value in a series)
- MIN (minimum value in a series)
- MAX (maximum value in a series)
- DIF (difference between MAX and MIN in a series)
- SDV (standard deviation for a series)
- RDV (variance coefficient)

13.10.1. Means of Operation

- Enter <STATISTICS> mode.
- Load the weighing pan with first object.

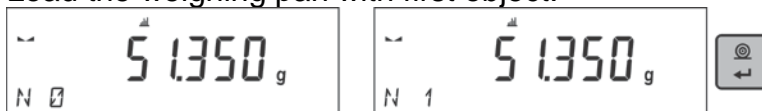

Wait for a stable indication and press  key to confirm. The measurement is saved to the balance memory and automatically printed out with assigned individual number.

- Unload the weighing pan.
- Measure subsequent load in a series.



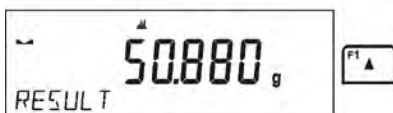

Upon saving all measurements you can verify the statistics. To do that, press  key:

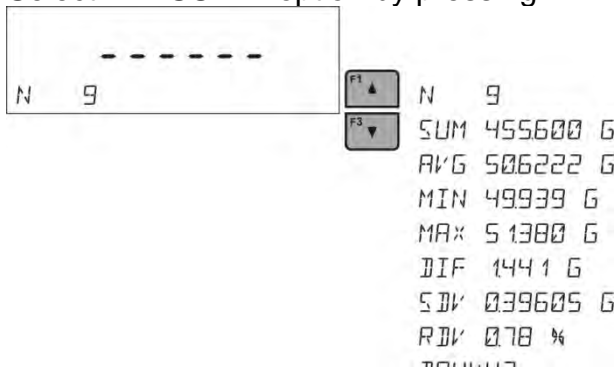

Select <RESULT> option by pressing  key.



Information on the quantity of saved measurements is displayed in the bottom line of the display. Each pressing of  or  keys changes the type of displayed information.

Upon selecting <PRINT> option and pressing  key, statistical data is printed out in a form of a report.

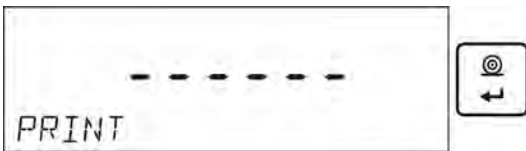

Report example:

Statistics	
N	9
Sum	455.600 g
Avg	50.6222 g
Min	49.939 g
Max	51.380 g
Dif	1.441 g
Sdv	0.39605 g
Rdv	0.78 %

13.10.2. Deleting Statistics

To delete statistics carried out for series of measurements, follow the instructions presented below:

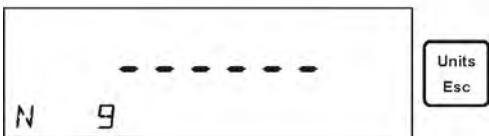

Upon starting <FINISH> option, statistics are automatically printed out and <RESULT> window is opened. This window allows you to verify and print the data again.

You return to <STATISTICS> mode home screen by pressing  key and the data on carried out measurements is automatically zeroed.



You can start new series of measurements or return to weighing mode.

13.11. Totalizing

Totalizing function allows you to weight ingredients of the formulation and to totalize their mass.

It is possible to totalize max. 30 weighings (ingredients) in one process.

F Quick Access Keys

Function enables assigning quick access functions which are to be accessible by pressing F1, F2, F3 or F4 keys.

For procedure informing you how to declare the particular function, read *F Quick Access Keys* section.

13.11.1. Additional Settings for Totalizing

Apart from standard settings for this mode (described in the weighing mode section), additional parameter has been introduced.

- **REP. PRNT. T.** – option for disabling printing the mass of a container used for weighing the ingredients on the report.

13.11.2. Means of Operation:

- Enter <TOTALIZING> mode.
The bottom line shows total sum and data relating to the number of ingredients which are added to the total sum and the total mass (if such information is selected in the settings for totalizing mode).
- Put the container (intended for the reference sample) on a weighing pan and tare it.

Put the first ingredient to the container, wait for a stable indication and press  key.



Sample mass is saved and as a result data on ingredients quantity and total sum, displayed in the bottom line, changes. Data on saved measurement is printed.

- Put next ingredients to the container, wait for a stable indication and press  key.
- If mass of the last added ingredient is incorrect, you can return to the previous procedure step and on changing the ingredient, add it again. In such case, follow the steps:



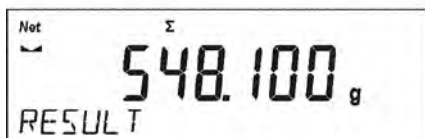

Upon weighing all samples, finish adding procedure by following the below steps:



In the bottom line message <RESULT> is displayed. It means that the total result of all measured ingredients masses is displayed and the sum is automatically printed. The report containing information on ingredients masses, total sum and used tare, is printed out automatically.

Report example:

REP. PRNT. T. - YES		REP. PRNT. T. - NO	
----- Totalizing -----		----- Totalizing -----	
1.	38.000 g	1.	38.000 g
2.	100.000 g	2.	100.000 g
3.	50.000 g	3.	50.000 g
4.	10.000 g	4.	10.000 g
5.	125.000 g	5.	125.000 g
-----		-----	
Sum	323.000 g	Sum	323.000 g
Tare	100.000 g	-----	
-----		-----	

Press  key to print the report again. Press  key to exit. You return to <TOTALIZING> mode home screen and the data on carried out measurements is automatically zeroed.

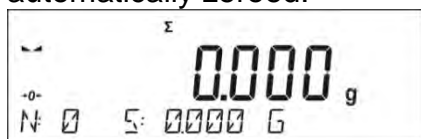

13.12. Peak Hold

Peak Hold is a working mode allowing you to snap value of maximum force applied to the weighing pan during one loading.

Apart from standard settings for this mode (described in the *Weighing* mode section), additional parameter has been introduced, it sets threshold value determining function activation. The parameter is to be found in <PEAK HOLD> working mode settings.

Option: **THRESHOLD** – function determining start point for peak hold control performed by the balance software. Remember to set this threshold prior measuring process.

F Quick Access Keys

Function enables assigning quick access functions which are to be accessible by pressing F1, F2, F3 or F4 keys. For procedure informing you how to declare the particular function, read *F Quick Access Keys* section.

13.12.1. Means of Operation

- Enter <PEAK HOLD> mode.
The function is active upon selecting the working mode. Information on net weight is displayed in the bottom part (unless another information is selected).
In order to provide proper operation, set the threshold (in grams) determining point beyond which the function starts to register maximum force applied.
- From now on the balance registers and holds every single weighing which is above the threshold, and which is higher than the result of the previous peak hold. If the software detects mass above the threshold, the highest detected indication is held on the main display and the pictogram <Max> is shown on the right over the measuring unit.



In order to print the result press  key.

The start of the next process of peak hold measurement is possible only after

removing the load from the weighing pan and pressing  key. This causes returning to the home screen of <PEAK HOLD> mode. Pictogram <Max> is automatically deleted.



Caution: Press Units/Esc key to select the unit. If a result is already snapped (Max pictogram is displayed), the Esc key deletes last snapped measurement result.

13.13. Basic Totalizing

Basic totalizing function allows you to add net masses of weighed samples.

This function enables adding maximum 9999 ingredients in one cycle or such quantity of samples for which the total weight value is short enough to be displayed on 8-segment display.

F Quick Access Keys

Function enables assigning quick access functions which are to be accessible by pressing F1, F2, F3 or F4 keys.

For procedure informing you how to declare the particular function, read *F Quick Access Keys* section.

13.13.1. Means of operation:

- Enter <BASIC TOTALIZING> mode.
The bottom line shows total sum and data relating to the number of ingredients which are added to the total sum and the total mass (if such information is selected in the settings for totalizing mode).
- Load the weighing pan with the first sample. Wait for a stable indication and press



key to confirm.



Sample mass is saved and as a result data on ingredients quantity and total sum, displayed in the bottom line, changes. Data on saved measurement is printed.



1. Net	38.00 g
Tare	0.000 g
Gross	38.00 g

- Next, take off the first sample and load the weighing pan with the second one. Wait for a stable indication and press  key to confirm.
- Add the remaining samples of the measurement series.
- If mass of the last added sample is incorrect, you can return to the previous procedure step and on changing the sample, add it again. In such case, follow the steps:



Upon adding all samples, finish basic totalizing procedure by following the below steps:

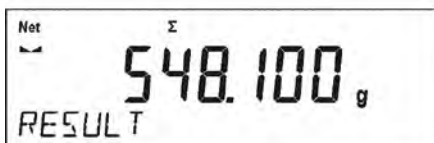



In the bottom line message <RESULT> is displayed. It means that the total result of all measured samples masses is displayed and the sum is automatically printed.

An exemplary printout:

1. Net	38.000 g
Tare	0.000 g
Gross	38.000 g
.	
.	
10. Net	15.000 g
Tare	0.000 g
Gross	15.000 g
-----Adding-----	
Sum	0.00 g

CAUTION: Upon adding process completion, only a summary is printed. The masses of particular samples are printed on confirmation.

You can print the sum once again. To do that, press  key. Press  key to exit. You return to <BASIC TOTALIZING> mode home screen and the data on carried out measurements is automatically zeroed.

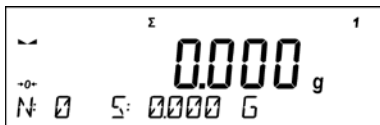



You can print an intermediate sum of saved samples. In such case, follow the steps presented below.



1. Net	38.000g
Tare	0.000g
Gross	38.000g
.	
.	
.	
5. Net	5.000g
Tare	0.000g
Gross	5.000g

Sum	43.100g

In order to continue basic totalizing process, press  key upon printing out the sum. Home screen of the main mode is displayed.

If the samples are measured with packaging, load the weighing pan with the packaging, wait for a stable indication and press  key.

CAUTION: In case of BASIC TOTALIZING mode, upon pressing  key (which is done to confirm sample weight) measurement data gets printed. The following data can be printed: **Measurement number**, **NET mass** (in adjustment unit), **TARE mass** (in current unit), **GROSS mass** (in current unit), and **current result** (in current unit). Data to be printed is to be set in GLP PRINTOUT parameter - read section 8 of this user manual. Other information (except the above-listed), such as: OPERATOR, PRODUCT, DATE, TIME, VARIABLE 1, VARIABLE 2, ADJUSTMENT REPORT, NON-STANDARD PRINTOUT are not printed for BASIC TOTALIZING mode.

13.14. Pipettes Calibration

Caution: Function available for MAS modules exclusively.

Pipettes calibration is carried out for fixed volume and adjustable volume pipettes. During the procedure, accuracy and repeatability errors are determined.

For adjustable volume pipettes, errors for Max, Min and ½ Max volume are determined.

All pipettes are verified if they meet the requirements of PN-EN ISO 8655:2003 standard concerning dosing accuracy and repeatability.

Use only distilled water for pipettes calibration.

Ambient conditions crucial for high accuracy calibration:

- The ambient temperature of the pipette, tip and liquid:
20°C ÷ 25°C, during weighing it must be stabilized within ± 0.5.°C
- Relative humidity: 50 ÷ 75%. Pipette, tips and distilled water have to be subjected to temperature stabilization carried out directly in the weighing room. The standard recommends the acclimatization for at least 2 hours.

Prior calibration start, install additional equipment (evaporation ring).

13.14.1. Additional Settings for Pipettes Calibration

Apart from standard settings for this mode (described in the *Weighing* mode section), additional parameters have been introduced concerning working mode operation.

Parameters:

- **VOLUME DETERMINATION** – option enables setting the quantity of tested volumes for particular pipette. Set: <1> value for fixed volume pipette or <2> or <3> for adjustable volume pipette.
- **MEASUR. NO.** – option enables setting quantity of measurements (repetitions) for each tested volume. Settings range: 6 to 20 measurements.
- **AUTOMAT. TARING** – option enables automatic taring of the dosed water upon each measurement confirmation (set to <YES> value).

Remember to set the above options to respective values in accordance with needs and requirements (resulting from operation conditions) prior pipettes calibration.

F Quick Access Keys

Function enables assigning quick access functions which are to be accessible by pressing F1, F2, F3 or F4 keys.

For procedure informing you how to declare the particular function, read F Quick Access Keys section.

13.14.2. Procedure:

- Enter <PIPETTE CALIBRATION> mode.
- Start process.

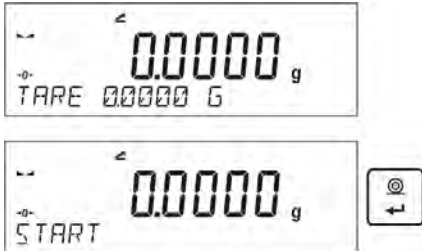

- Enter process settings. Follow the displayed messages.
- Specify ambient temperature and press ENTER key.



- Upon entering the temperature and pressing <ENTER> key to confirm, the software proceeds to next step. Set ambient humidity.



- Upon entering the humidity and pressing <ENTER> key to confirm, the software proceeds to next step. Set atmospheric pressure.



- Upon entering the atmospheric pressure and pressing <ENTER> key to confirm, the software proceeds to next step. Enter first tested volume (V1) of the tested pipette. In case of fixed volume pipettes (P2.13.5 VOLUME DETERMINATION parameter set to <1> value) this is the only volume to be entered.



- Upon entering the first volume and pressing <ENTER> key to confirm, the software proceeds to next step. Enter next tested volume (V2) of the tested pipette.



- Upon entering next volume and pressing <ENTER> key to confirm, the software proceeds to next step. Enter next tested volume (V3) of the tested pipette.



- Upon entering this data, the software proceeds to pipette calibration.



- Follow the messages displayed in the bottom line to carry out the procedure.
- Next, dose the first portion of the water using pipette and upon stabilization of the result press <ENTER> key to confirm.



- The measurement is saved to balance memory. If <AUTOMAT. TARING> parameter is set to <YES> value, the indication is tared automatically. If the parameter is set to <NO> value, tare balance indication by pressing <TARE> key, before dosing next portion.
- Upon carrying out series of measurements for given volume, a summary is displayed.

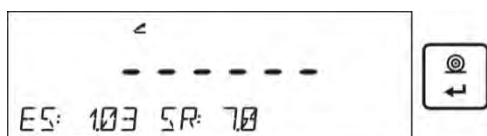

To proceed to next measurements, press <ENTER> key. Press <Esc> key to finish the measurement. The software finishes the procedure and displays home screen of the main mode.

- Upon pressing <ENTER> key during displaying summary of the last volume of the adjustable volume pipette (fixed volume pipettes – V1 volume summary), a report is automatically generated and printed on a connected printer (ambient conditions values on a report are the values entered on the beginning of the calibration process).

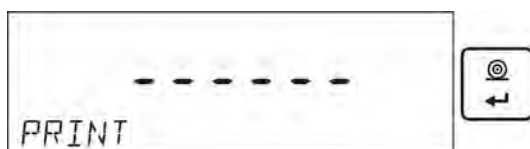

- Home screen of the main mode is displayed.
- You can start new procedure for the same pipette or enter new data for another pipette.

Report example - adjustable volume pipette, 3 volumes test:

-----Pipettes calibration-----

Measur. No.	10
Date	24.04.2014
Time	11:31:27
Temp.	22.0 °C
Humidity	50 %
Pressure	1013 hPa

-----Tested volume: 1000 µl-----

1	1003 µl
2	993 µl
3	1013 µl
4	1023 µl
5	1003 µl
6	993 µl
7	1003 µl
8	1013 µl
9	1053 µl
10	1003 µl

Average volume [Va]	1010 µl
Systematic error [Es]	1.03 %
Random error [Sr]	17.7 µl

-----Tested volume: 5000 µl-----

1	4966 µl
2	4966 µl
3	4966 µl
4	4986 µl
5	4976 µl
6	4966 µl
7	4966 µl
8	4976 µl
9	4976 µl
10	4976 µl

Average volume [Va]	4972 µl
Systematic error [Es]	0.56 %
Random error [Sr]	7.0 µl

-----Tested volume: 10000 µl-----

1	10033 µl
2	10033 µl
3	10033 µl
4	10033 µl
5	10043 µl
6	10043 µl
7	10043 µl
8	10043 µl
9	10043 µl
10	10043 µl

Average volume [Va]	10039 µl
Systematic error [Es]	0.39 %
Random error [Sr]	5.2 µl

Signature

.....

14. COMMUNICATION

Communication menu enables configuration of ports settings.

It is accessed by pressing  key.

The balance can communicate with peripheral instruments, the communication is established via the following ports:

- COM 1 (RS232),
- USB 2 type B,
- Wi-Fi.

USB ports parameters are not configurable. Type B port is used for connecting the computer.

14.1. RS 232 (COM) Ports Settings

Procedure:

- Select <COM 1> communication port.
- Next, set respective values:

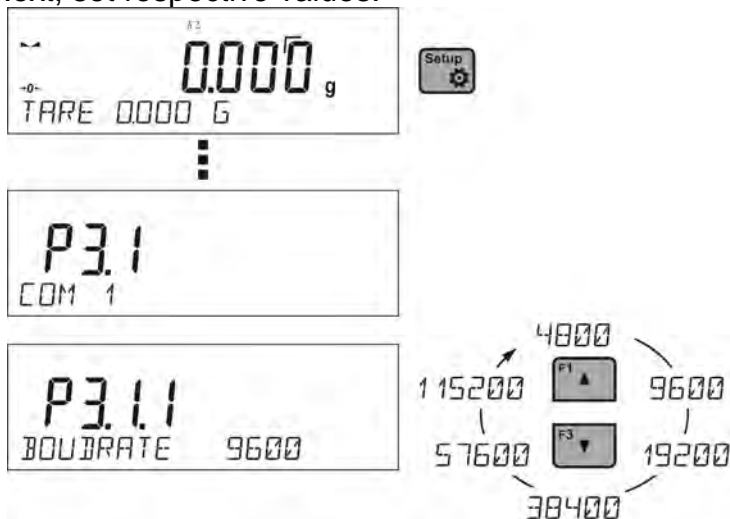

Transmission parameters for RS 232 ports:

- baud rate – 2400, 4800, 9600, 19200, 38400, 57600, 115200 bit/s,
- parity – NONE, ODD, EVEN.

14.2. Wi-Fi Settings

Caution:

1. Set the transmission parameters in accordance with the local network.
2. In order to provide correct communication between the computer and the weighing instrument via <WIFI port>, you must set computer port parameter in the balance to value < WIFI >: **P4.1.1 <PERIPHERALS/COMPUTER/PORT/WIFI**

Parameters for setting wireless connection:

P3.3.1 – STATUS

P3.3.2 – WIFI

P3.3.3 – SELECT WIFI

P3.3.4 – WIFI SET.

P3.3.4.1 – DHCP

P3.3.4.2 – NAME (name of a selected network)

P3.3.4.3 – PASSWORD (network password - visible asterisks)

P3.3.4.4 – IP (balance identification number, please note that this number is not used by other instruments operating in a network)

P3.3.4.5 – MASK (by default: 255.255.000.000)







P3.3.4.6 – GATE (by default 10.10.8.244)

P3.3.4.7 – MAC ADDR. (0008DC.....)

Upon entering the parameter, message <STATUS> and the status of current connection with Wi-Fi network are displayed in the bottom line.

- **CONNECTED** – the weighing instrument is connected to one of the available Wi-Fi networks,  pictogram is displayed in the upper part. The pictogram is displayed continuously when the balance has an active wireless communication.
- **CONNECTING** – the weighing instrument is establishing connection with the last network used, with previously entered settings (network, IP, etc.).
- **ERROR** – the weighing instrument is not equipped with Wi-Fi module or the module is disabled in P3.3.2 *Wi-Fi* parameter (parameter set to NO value).

Connection procedure:

- Enable Wi-Fi module – P3.3.2 <COMMUNICATION/WIFI - YES> parameter.
- Next, in P3.3.4.1 <COMMUNICATION/WIFI./WIFI SET./DHCP> parameter set DHCP:
 - to set DHCP to NO value, enter manually: <IP; MASK; DEF. GATE.>,
 - to set DHCP settings to YES value, the software automatically reads and displays the data; assigned by Wi-Fi router to which the weighing instrument is connected.
- Enter P3.3.3 <WIFI SET.> and press  key to start searching for available networks. Searching procedure starts. Upon completion, list of detected networks is displayed in the bottom line.
- Using  and  keys, select network and press  key.
- Message <PASSWORD *****> is displayed in the bottom line. To enter the password use computer keyboard connected to USB port. Such keyboard enables entering upper and lower case letters of the password (the weighing instrument keypad enables entering capital letters and numeric characters only). Enter the password and press  key to confirm.
- Upon selecting the network and entering the password, establishing connection starts automatically.
- Enter <P3.3.1 STATUS> parameter, it features <CONNECTING> message, operation of connecting the balance to the network is in progress.
- For successfully established connection <CONNECTING> status turns to <CONNECTED> status,  pictogram is displayed.
- If you are waiting too long for the communication to be established (<CONNECTING> status displayed in the bottom line) it means that incorrect parameters must have been entered (e.g. password, IP, etc.).
- Check the settings and try to establish communication again.
- If you fail to establish the communication, contact RADWAG service team.

The selected network and connection parameters are stored by the balance program. The program connects to the network in accordance with the stored parameters each time the balance is switched on.

To disconnect the network turn the communication off: <COMMUNICATION/ WIFI / WIFI.
- NO>

14.3. USB Port

USB port of type B is intended for connecting the weighing instrument to a computer.



In order to make connection of balance and computer possible, it is necessary to install virtual COM port in a computer.

To carry out this procedure, you need a respective driver installer which may be either downloaded from the website www.radwag.pl or taken from a CD storing the manuals: *R X2 SERIES RADWAG USB DRIVER x.x.x.exe*.

Procedure:

1. Run driver installer.

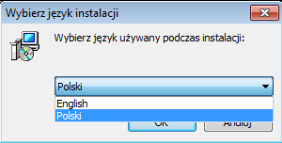
Start-up dialog window:

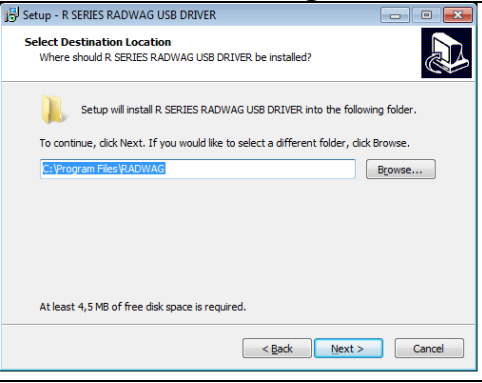
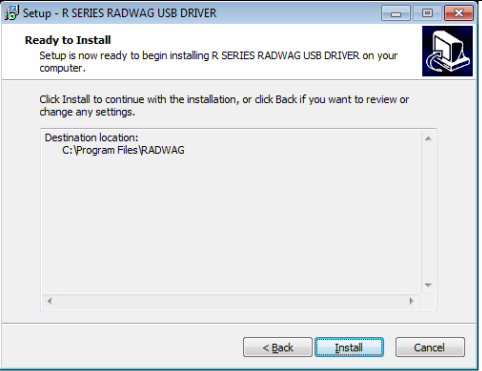
	Select language version.
	In order to continue, press 'Next' button.
<p>Window for selecting installation path:</p> 	Select a respective folder and click 'Next' button to proceed.
<p>'Ready to Install' window:</p> 	In order to run installation process, press „Install” button and clicking respective keys, follow the install wizard.

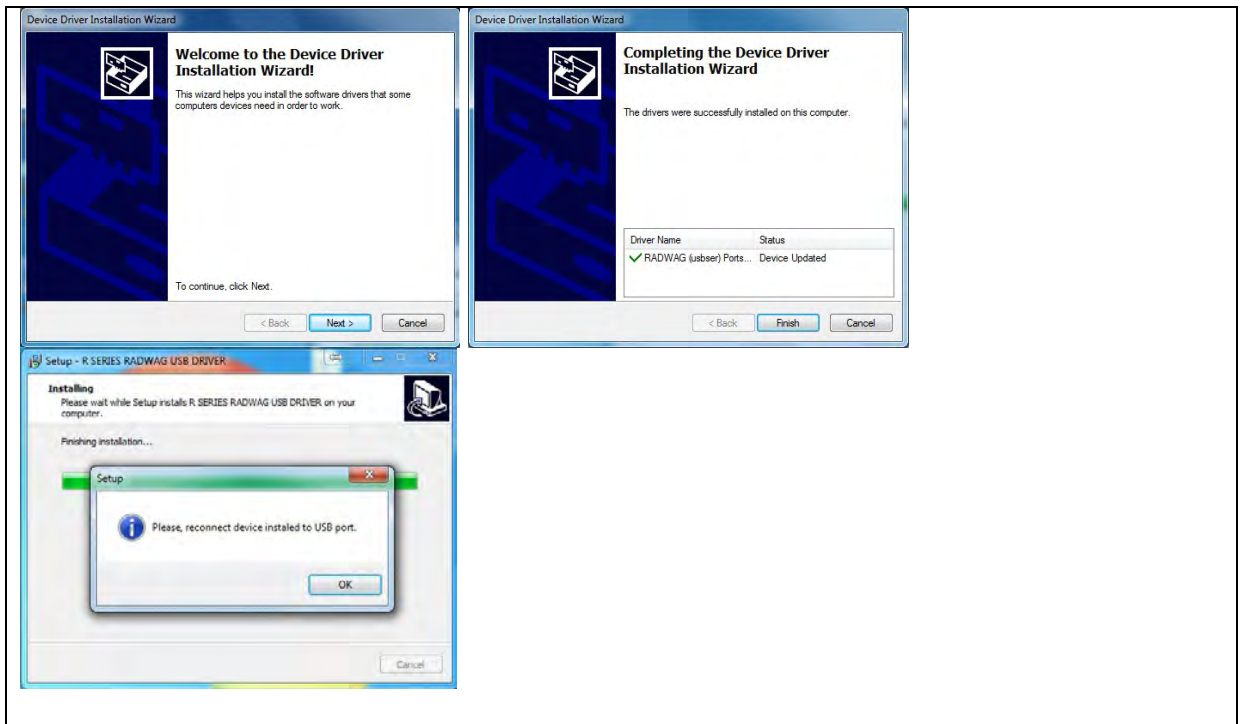

- Having completed driver installation, connect the module to a computer, use maximum 1.8-meter long USB A/B cable (if the balance is already connected, disconnect it, next reconnect using USB cable).



- The system detects the new USB device and automatically starts searching for a respective driver.
- Go to Device Manager and check number assigned to virtual COM port.

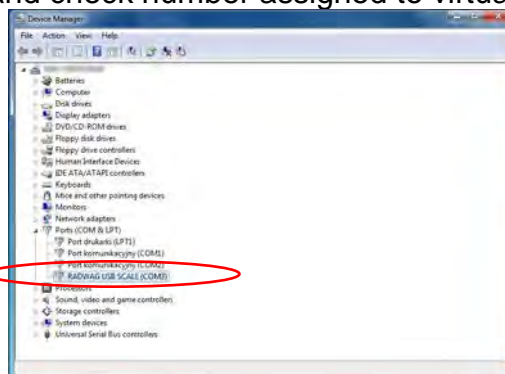

For this very case it is RADWAG USB SCALE (COM3).

- Set balance parameters: Select <USB> value for <P4.1.1 COMPUTER/PORT> parameter.

6. Run software for measurements readout.
7. Set communication parameters – select COM port that was installed in the course of drivers installation (in this very case it is COM3).
8. Start cooperation.

15. PERIPHERALS

Peripherals menu is to be found in Parameters menu. It is accessed by pressing  key. The menu features list of instruments that can cooperate with the module.

15.1. Computer

In <COMPUTER> submenu you can select port to which computer is connected. The computer is equipped with software enabling balance-computer communication, enabling/disabling continuous transmission and enabling/disabling cooperation between the weighing instrument and RADWAG-manufactured E2R computer software.

15.1.1. Computer Port

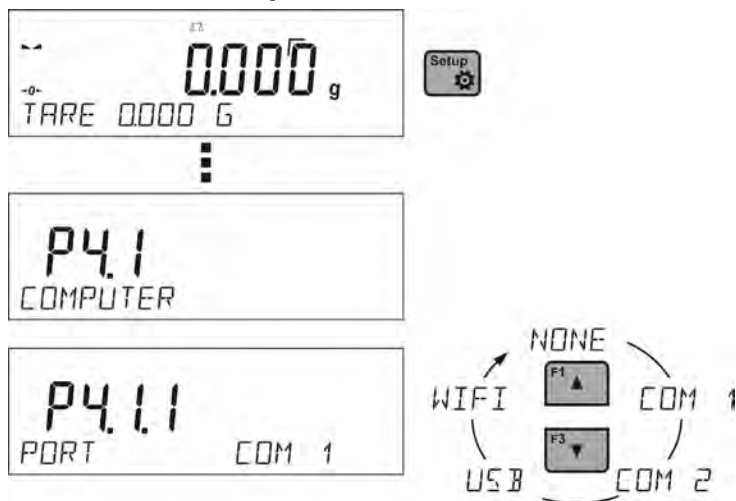

Procedure:

- Press  key.
 - Enter <P4 PERIPHERALS> menu.
 - Enter <P4.1 COMPUTER> menu.
 - Select port for connecting a computer:
 - **COM 1** – RS 232 port for connecting a computer,
 - **USB** type B – USB port for connecting a computer,
 - **USB FREE LINK** - USB port type B for connecting a computer. Tool for entering data, it functions as a keyboard. Upon proper modification of non-standard printout and sending proper command from the computer, or upon pressing ENTER key located on the operation panel, the data from non-standard printout is entered directly to computer programs, e.g. Excel, Word, Notepad etc.
- Select <USB FREE LINK> port and configure its settings in order to enable correct cooperation of the balance with computer programs:

SPREADSHEET - value YES --.-- - cooperation with Excel type program, (.) dot is used as decimal point while sending the mass value,
 - value YES --.-- - (,) - comma is used as decimal point while sending the mass value

- value NO - cooperation with other programs (mass value is sent as a text),

DELAY – if the transferred information is incomplete, i.e. part of it gets lost (due to auto-entering or auto-formatting of data by computer program) during cooperation with Excel type program, set the parameter value to <2>. If the transferred information is still incomplete, the parameter value must be higher. The value ranges between 0 (quick data transfer) and 9 (slow data transfer – around 10 characters per second).

- **WIFI** – Wi-Fi port.

15.1.2. Continuous Transmission

Parameter enables to turn on/off continuous transmission of a weighing result. Available options:

- continuous transmission in <**ADJUSTMENT UNIT.**>: indications are transmitted in the main unit (adjustment unit) independently from currently operated unit of mass,
- continuous transmission in <**CURRENT UNIT.**>: indications are transmitted in a currently operated unit of mass, the transmitted unit changes along with the current unit change (Units key),
- continuous transmission turned off: <**NONE.**>.

Procedure:

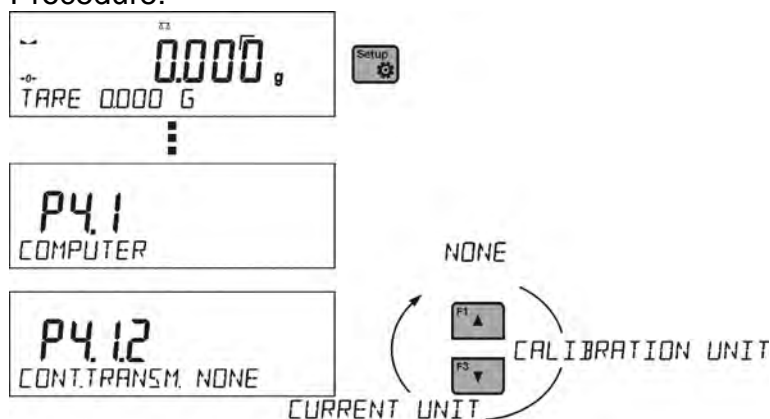

Caution:

Continuous transmission can be turned on/off by a respective message sent from a computer (read: 15 COMMUNICATION PROTOCOL).

15.1.3. Interval for Printouts During Continuous Transmission

<P4.1.3 INTERVAL> parameter enabling you to set frequency of printouts for continuous transmission.

Frequency of printouts is set in seconds, wherein the accuracy is 0.1s.

Time values range between 1000s. and 0.1 s.

The setting is valid for continuous transmission in adjustment unit and in current unit activated by means of the balance (read: P4.2.1.2 parameter). It is also valid for continuous transmission activated by command sent from a computer (read: 15 COMMUNICATION PROTOCOL).

15.1.4. Cooperation with E2R

E2R is a control system designed to monitor all weighing processes carried out using weighing instrument, with E2R system activated some databases can be operated using

computer exclusively (access to specified functions and options using weighing instrument is not possible).

To start cooperation with E2R system, set <E2R SYSTEM> parameter to <YES> value.

Caution:

<E2R System> parameter can be activated only by an operator with administrator permissions level. Turn the continuous transmission off in order to provide correct cooperation with E2R system.

15.1.5. Printout

Printout type that is sent to the port to which the computer is connected.

Procedure:

- Press  key.
- Enter <P4 PERIPHERALS> menu.
- Enter <P4.1 COMPUTER> menu.
- Select <P4.1.7 PRINTOUT> parameter.
- Select printout:
 - **NONE** – no printout selected
 - **NSD. PRN. 1 ÷ 4** – one of the non-standard printouts (*read non-standard printouts section*)
 - **MOB. APP** – special printout (frame with data sent from the weighing instrument) recognized by a special application for previewing weighing result on mobile devices.

15.2. Printer

Submenu <PRINTER> enables you to select a port to which data is to be sent upon

pressing  key. Content of sent data is set in <PRINTOUTS/GLP PRINTOUTS> parameter.

Procedure:

- Press  key.
- Enter <P4 PERIPHERALS> menu.
- Enter <P4.2 PRINTER> menu.
- Select port for connecting a printer:
 - **COM 1** – RS 232 port for connecting a printer.
 - **WIFI** – Wi-Fi port that sends data to RADWAG-manufactured PW-WIN software opened on a computer connected to the weighing instrument via Wi-Fi.
 - **USB PC** – USB 2 port, type B, for connecting a computer with a dedicated RADWAG software, e.g. PW-WIN.
 - **USB FREE LINK** - USB port type B for connecting a computer. Tool for entering data, it functions as a keyboard. Upon proper modification of non-standard printout and pressing assigned key (e.g. F1 header, F3 footer, ENTER printout) the data is entered directly to computer programs, e.g. Excel, Word, Notepad etc. Select <USB FREE LINK> port and configure its settings in order to enable balance correct cooperation of the balance with computer programs:

SPREADSHEET - value YES --.-- - cooperation with Excel type program, (.) dot is used as decimal point while sending the mass value,

- value YES --.-- - (,) - comma is used as decimal point while sending the mass value

- value NO - cooperation with other programs (mass value is sent as a text,

DELAY – if the transferred information is incomplete, i.e. part of it gets lost (due to auto-entering or auto-formatting of data by computer program) during cooperation with Excel type program, set the parameter value to <2>. If the transferred information is still incomplete, the parameter value must be higher. The value ranges between 0 (quick data transfer) and 9 (slow data transfer – around 10 characters per second).

Caution: *An exemplary measurement printout is described in the PRINTOUTS section.*

Additionally you can send a controlling code (of a hexadecimal form) to a printer either at the beginning of the printout <P4.2.2 PREFIX> parameter, or at the end of it - <P4.2.3 SUFFIX> parameter. Sending these codes enables to globally control information and actions carried out at the beginning and/or at the end of each printout sent from a weighing instrument to a printer.

This function is most frequently used to:

- send an information about the printout's code page, at the beginning; and
- to send a command enabling the crop of a paper in EPSON printers (if the printer is equipped with an auto cutter blade), at the end.

Settings of <PREFIX> and <SUFFIX> parameters are valid for all printouts sent via the weighing instrument, e.g.: adjustment reports, statistics etc., and header, footer and GLP printouts.

Caution:

It must be remembered that inserting paper crop command to <SUFFIX> parameter (control code) results in sending the code after each printout. If you wish for one whole printout to consist of: HEADER, GLP PRINTOUT and FOOTER and to be cropped underneath the FOOTER, then the paper crop command should be inserted only for FOOTER settings as a non-standard printout with <%E> variable (paper crop for EPSON printer). In such a case <SUFFIX> command must remain empty.

To ensure correct cooperation of the balance with the printer (correct printout of diacritical signs of a given language), respective baud rate, obligatory for a given printer, must be selected (read the printer settings). Additionally code page of a sent printout must be accordant with a code page of a printer.

There are two methods for obtaining code page accordance:

- by setting the right code page in printer settings (read printer's user manual) – it must be accordant with the printout code page of a weighing instrument:(code page **1250** for the following languages: POLISH, CZECH, HUNGARIAN code page **1252** for the following languages: ENGLISH, GERMAN, FRENCH, SPANISH, ITALIAN code page **1254** for TURKISH),
- by sending the control code from the weighing device, which, prior the printout, automatically sets the right code page of the printer, i.e. code page accordant with the one of a weighing instrument (read user manual of the printer you operate to check if it supports this option).

Caution:

CODES MUST BE ENTERED IN A HEXADECIMAL FORM!

*Exemplary balance settings for correct cooperation with EPSON **TM-U220B** printer connected to RS232 port (due to the fact, that the printer features only code page 852the printout does not contain Polish signs):*

1. EPSON TM-U220B

Communication parameters for port to which the printer is connected:

- BAUD RATE - 9600 bit/s
- PARITY – none

Printer parameters set for PERIPHERALS group:

- PORT - COM 1 (port for connecting a printer)
- PREFIX – **1B742D** (code page**1250**)
- SUFFIX – **1D564108** (paper crop EPSON)

Exemplary balance settings for correct cooperation (printout of Polish signs) with EPSON **TM-T20** printer connected to RS232 port (if the printer is connected to USB port, baud rate and parity parameters are irrelevant):

2. EPSON TM-T20

Communication parameters for port to which the printer is connected:

- BAUD RATE – 38400 bit/s
- PARITY – none

Printer parameters set for PERIPHERALS group:

- PORT - COM 1 (port for connecting a printer)
- PREFIX – **1B742D** (code page**1250**)
- SUFFIX – **1D564108** (paper crop EPSON)

If on the printout in the place of the last digit there are any unexpected signs (for verified balances), then <P4.2.2 PREFIX> parameter must incorporate, apart from code page, code of the UK signs chart: **1B5203**.

In such case the <P4.2.2 PREFIX> parameter is set as follows:

- PREFIX – **1B742D1B5203** (code page**1250** and UK signs change)

Control codes for exemplary code pages:

Control code	Page or other command
1B742D	Code page 1250
1B7410	Code page 1252
1B7430	Code page 1254
1B5203	UK signs chart
1B5202	DE signs chart
1D564108	Paper crop
0C	Form feed (for PCL printers)

15.3. Barcode Scanner

Submenu <BARCODE SCANNER> comprises settings for cooperation with barcode scanner.

Procedure:

- Press  key.
- Enter <P4 PERIPHERALS> menu.
- Enter <P4.3 BARCODE SCANNER> menu and select port for connecting barcode scanner:
NONE, COM 1.

15.4. Additional Display

Submenu <ADD. DISPLAY> comprises settings for cooperation with an external additional display WD-6.

Procedure:

- Press  key.
- Enter <P4 PERIPHERALS> menu.
- Enter <P4.4 ADD. DISPLAY> menu, select port for connecting additional display: **NONE, COM 1.**

Caution:

The balance cooperates with RADWAG additional display. Ensuring correct cooperation between the weighing device and the additional display requires baud rate parameter value to be set to 115200 bit/s for the port to which the additional display is plugged.

16. ERROR MESSAGES

-Err2-	Value beyond zero range
-Err3-	Value beyond tare range
-Err8-	Zeroing/taring time out of range
-NULL-	Zero value from converter
-FULL-	Weighing range exceeded
-LH-	Start mass error

17. ADDITIONAL EQUIPMENT

Anti-vibration table



It provides a stable base which eliminates all vibrations. A marble plate is installed inside the table, it is a base for the weighing instrument.

Additional display



Characteristics: the length of the cable connecting additional display and weighing instrument is 1.5 m, plastic housing, possibility to bend the terminal.

AP2-1 current loop



RADWAG-manufactured 4-20mA current loop module is intended for digital to analog converting of the mass readout. AP2-1 is equipped with plastic housing. Powered by 230V/5VDC external power supply. AP2-1 and the power supply compose a set. The current circuit is led through twin-core cable of 1.7m length.

*User manual number:
IMMU-13-04-01-18-EN*



RADWAG BALANCES AND SCALES
ADVANCED WEIGHING TECHNOLOGIES

