

# 4Y Mass Comparators

**HRP 200.4Y.KO Mass Comparator**

**\* HRP 200.4Y.KO \* Mass Comparator - with self-centring weighing pan**

**HRP 500.4Y.KO Mass Comparator**

**\* HRP 500.4Y.KO \* Mass Comparator - with self-centring weighing pan**

**HRP 1000.4Y.KO Mass Comparator**

**\* HRP 1000.4Y.KO \* Mass Comparator - with self-centring weighing pan**

**HRP 2000.4Y.KO Mass Comparator**

**\* HRP 2000.4Y.KO \* Mass Comparator - with self-centring weighing**

## USER MANUAL

IMKO-08-07-12-18-ENG



**RADWAG**  
RADWAG BALANCES AND SCALES  
ADVANCED WEIGHING TECHNOLOGIES

If you are reading this, it means that you are bound to achieve success.  
You have purchased a device that was designed and manufactured to give you years of service.  
Congratulations and thank you for selecting RADWAG product.

December 2018

## Contents

<b>1. GENERAL INFORMATION</b>	<b>7</b>
1.1. Intended Use	7
1.2. Precautions	7
1.3. Warranty Conditions	7
1.4. Supervision over Metrological Parameters	7
1.5. User Manual Significance	7
1.6. Operator Training	8
<b>2. TRANSPORT AND STORAGE</b>	<b>8</b>
2.1. Delivery Checklist	8
2.2. Packaging	8
<b>3. UNPACKING AND INSTALLATION</b>	<b>8</b>
3.1. Workstation	8
3.2. Unpacking	8
3.2.1. HRP 200 and HRP 500 Mass Comparators Unpacking	9
3.2.2. HRP 1000 Mass Comparator Unpacking	11
3.2.3. HRP 2000 Mass Comparator Unpacking	14
3.3. Maintenance Activities	18
3.4. Connecting the Weighing Instrument to the Mains	19
3.5. Temperature Stabilization Time	19
3.6. Connecting Additional Hardware	19
<b>4. START-UP</b>	<b>20</b>
<b>5. OPERATION PANEL</b>	<b>20</b>
<b>6. PROGRAM</b>	<b>20</b>
<b>7. WEIGHING RESULT WINDOW</b>	<b>21</b>
<b>8. LOG IN OPERATION</b>	<b>22</b>
<b>9. OPERATING THE MENU</b>	<b>23</b>
9.1. Buttons	23
9.2. Return to the Comparison Mode	23
<b>10. COMPARISON</b>	<b>24</b>
10.1. Selecting Comparison Unit	24
10.2. Correct Comparison Principles	24
10.3. Mass Comparator Levelling	25
10.4. Zeroing	25
10.5. Taring	25
10.6. Running Working Mode	26
10.7. Working Mode – Comparator	26
10.8. Selecting Measuring Method in Mass Comparator	27
10.9. Determining Cycles Quantity	28
10.10. Determining Quantity of Start-up Weighing Cycles	28
10.11. Start Delay	29
10.12. Tare Mode	29
10.13. Printout/Enter Mode	29
10.14. Printouts	30
10.15. Completed Comparison Processes Report	31

10.16.	Display Arrangement .....	31
10.17.	Mass Comparison Process - Basic Procedure .....	32
<b>11.</b>	<b>ADJUSTMENT .....</b>	<b>33</b>
11.1.	Internal Adjustment .....	33
11.2.	External Adjustment .....	34
11.3.	User Adjustment .....	34
11.4.	Adjustment Test.....	34
11.5.	Automatic Adjustment .....	34
11.6.	Automatic Adjustment Time.....	34
11.7.	Scheduled Adjustments.....	35
11.8.	Adjustment Weights .....	36
11.9.	Report Printout .....	37
11.10.	GLP Project .....	37
11.11.	Adjustment History .....	38
<b>12.</b>	<b>OPERATORS .....</b>	<b>38</b>
<b>13.</b>	<b>PERMISSIONS.....</b>	<b>39</b>
<b>14.</b>	<b>PROFILES.....</b>	<b>42</b>
14.1.	Creating a Profile .....	42
14.2.	Profile Structure .....	42
14.2.1.	Settings .....	43
14.2.2.	Working Modes .....	43
14.2.3.	Readout .....	44
14.2.4.	Measuring Units .....	45
<b>15.</b>	<b>DATABASES.....</b>	<b>45</b>
15.1.	Processes Carried Out on Databases .....	46
15.2.	Products.....	47
15.3.	Weighings .....	47
15.4.	Customers.....	48
15.5.	Reference Weights.....	48
15.6.	Test Weights.....	49
15.7.	Comparison Procedures.....	49
15.8.	Comparison Reports .....	50
15.9.	Ambient Conditions .....	50
15.10.	Packaging .....	51
15.11.	Warehouses .....	51
15.12.	Printouts .....	51
15.13.	Universal Variables.....	53
15.14.	Databases Management .....	54
15.14.1.	Export Weighing Database to a File.....	54
15.14.2.	Delete Databases .....	55
15.14.3.	Delete Weighings and Reports.....	56
<b>16.</b>	<b>COMMUNICATION .....</b>	<b>57</b>
16.1.	RS 232 Settings .....	57
16.2.	ETHERNET Settings .....	57
16.3.	Wi-Fi Settings .....	58
16.4.	TCP Settings.....	59
<b>17.</b>	<b>PERIPHERALS .....</b>	<b>59</b>
17.1.	Computer .....	59

17.2. Printer .....	60
17.3. Barcode Scanner .....	61
17.3.1. Port .....	61
17.3.2. Prefix/Suffix.....	61
17.3.3. Field Selection .....	62
17.3.4. Test.....	63
17.4. Transponder Card Scanner .....	63
17.5. Additional Display.....	64
17.6. Ambient Conditions Module .....	64
<b>18. INPUTS/OUTPUTS.....</b>	<b>64</b>
<b>19. MISCELLANEOUS.....</b>	<b>66</b>
19.1. Language .....	66
19.2. Date and Time .....	66
19.3. Touch Panel Sound .....	67
19.4. „Beep” Sound .....	67
19.5. Volume .....	67
19.6. Display Sleep Mode .....	67
19.7. Display Brightness.....	68
19.8. Touch Panel Calibration.....	68
19.9. Level Control .....	68
19.10. Proximity Sensors Sensitivity.....	68
19.11. Proximity Sensors Timeout .....	69
19.12. Autotest.....	69
19.13. Start-Up Logo.....	72
19.14. Export of System Events .....	72
<b>20. AMBIENT CONDITIONS .....</b>	<b>73</b>
<b>21. UPDATE.....</b>	<b>74</b>
<b>22. ABOUT .....</b>	<b>74</b>
<b>23. VIDEOS .....</b>	<b>74</b>
<b>24. COMMUNICATION PROTOCOL .....</b>	<b>75</b>
24.1. List of Commands.....	76
24.2. Response Format .....	77
24.3. Manual Printout/Automatic Printout .....	90
<b>25. PERIPHERAL DEVICES.....</b>	<b>91</b>
<b>26. ERROR MESSAGES.....</b>	<b>91</b>
<b>27. ADDITIONAL EQUIPMENT .....</b>	<b>91</b>
<b>28. APPENDIX A - Variables for Printouts .....</b>	<b>92</b>
28.1. Variables List .....	92
28.2. Variables Formatting.....	101
<b>29. APPENDIX B – Programmable Buttons List .....</b>	<b>103</b>
<b>30. APPENDIX C - CITIZEN Printer Settings.....</b>	<b>104</b>
<b>31. APPENDIX D - ZEBRA Printer Settings .....</b>	<b>104</b>
<b>32. APPENDIX E - Communication with Barcode Scanner .....</b>	<b>104</b>
<b>33. APPENDIX F – Menu Structure .....</b>	<b>105</b>



## **1. GENERAL INFORMATION**

### **1.1. Intended Use**

4Y mass comparators enable determining difference between mass of a test weight (B) and known reference weight (A) during calibration process.

Mass comparators are widely applied in laboratories and in national metrological institutes for mass standards and weights calibration.

### **1.2. Precautions**

- Prior first use, carefully read this User Manual. Use the comparator only as intended.
- Do not operate the touch panel using sharp-edged tools (knife, screwdriver, etc.).
- While loading the balance make sure that loads are placed in the very centre of the weighing pan.
- Load the weighing pan with loads gross weight of which does not exceed instrument's measuring range (maximum capacity).
- In case of damage, immediately unplug the instrument from the mains.
- Mass comparator to be decommissioned, should be decommissioned in accordance with valid legal regulations.
- Not intended for usage within EX zones. Mass comparator is not designed to operate in EX zones.

### **1.3. Warranty Conditions**

- A. RADWAG feels obliged to repair or exchange all elements that appear to be faulty by production or by construction,
- B. Defining defects of unclear origin and means of their elimination can only be realized with assistance of manufacturer and user representatives,
- C. RADWAG does not bear any responsibility for damage or losses resulting from unauthorized or inadequate performing of production or service processes,
- D. Warranty does not cover:
  - mechanical damage caused by product exploitation other than intended, defects of thermal and chemical origin, defects caused by lightning, overvoltage in the power network or other random event,
  - mechanical damage caused by mass comparator exploitation other than intended,
  - mass comparator damage, if service claims removing or destroying protective stickers which secure its housing against unauthorized access,
  - damage caused by liquids, water and natural wear,
  - mass comparator damage caused by inappropriate setting or by electrical wiring failures,
  - damage caused by overloading of the mechanical measuring system,
  - maintenance activities (mass comparator cleaning).
- E. Loss of warranty takes place if:
  - a repair is carried out outside RADWAG authorized service point,
  - service claims intrusion into mechanical or electronic construction by unauthorized people,
  - other version of the operating system is installed in a mass comparator,
  - mass comparator does not bear company protective stickers.
- F. Detailed warranty conditions are listed on a service card.

### **1.4. Supervision over Metrological Parameters**

Metrological parameters of mass comparator need to be checked in determined time intervals. Inspection frequency depends on ambient conditions in which the mass comparator is used, types of performed processes and accepted quality management system in organization.

### **1.5. User Manual Significance**

It is very important to read the user manual carefully before switching on and starting up mass comparator operation, even if you are experienced and have worked with this type of comparator

before. This user manual contains crucial information for correct operation of the mass comparator; following the guidelines guarantees trouble-free operation of the comparator.

## 1.6. Operator Training

Mass comparator has to be utilized and supervised only by operators who are trained and experienced in using such type of weighing instruments.

## 2. TRANSPORT AND STORAGE

### 2.1. Delivery Checklist

Upon delivery it is necessary to check the package and the device, make sure that your package bears no signs of damage. If it does contact the manufacturer's representative.

### 2.2. Packaging

Keep all package elements should your device be transported in the future. Remember that only original packaging can be used for shipping purposes. Prior packing, uncouple any cables, remove any separable components (weighing pan, shields, inserts). The mass comparator components shall be packed into an original packaging, thus being protected against potential damage during transportation.

#### **Caution:**

*While preparing the mass comparator to be packed, disassemble the comparator in reverse order to the comparator installation presented in section 3. Make sure the mechanism interlocks are reassembled to prevent damage of the comparator.*

## 3. UNPACKING AND INSTALLATION

### 3.1. Workstation

- Mass comparator has to be stored and used in locations free of vibrations and shakes, free of air movement and dust.
- Ambient air temperature cannot exceed the range of:  $+15\text{ °C} \div +30\text{ °C}$  and its change cannot exceed  $0.5\text{ °C}/12\text{h}$ .
- Relative humidity range:  $40\% \div 60\%$  and its change cannot exceed  $2\%/4\text{h}$ .
- Mass comparator has to be located on the floor that is not affected by vibrations and distant from heat sources.
- Take special precaution when calibrating magnetic weights, as part of the comparator is a strong magnet. Weights magnetic cannot exceed the values presented in the table below:

Susceptibility,  $\chi$

Weight class	$E_1$	$E_2$	$F_1$	$F_2$
$m \leq 1\text{ g}$	0,25	0,9	10	-
$2\text{ g} \leq m \leq 10\text{ g}$	0,06	0,18	0,7	4
$20\text{ g} \leq m$	0,02	0,07	0,2	0,8

### 3.2. Unpacking

Cut the adhesive tape. Take the device out of the packaging. Open the accessory box, take the device components out of it.

#### **Standard delivery components list**



- Mass comparator
- Weighing pan
- Indicator
- Power supply
- Set of screws
- User Manual - CD version

**Prior mass comparator installation, read this user manual in order to correctly prepare the device for operation. Install the mass comparator at the workstation.**

**Caution:**

*Be careful so as not to damage the mechanism. At least 2 people are required for mass comparator installation.*

### **3.2.1. HRP 200 and HRP 500 Mass Comparators Unpacking**

1. Take the platform out of the packaging. Hold only the 'EXTERNAL FRAME'.

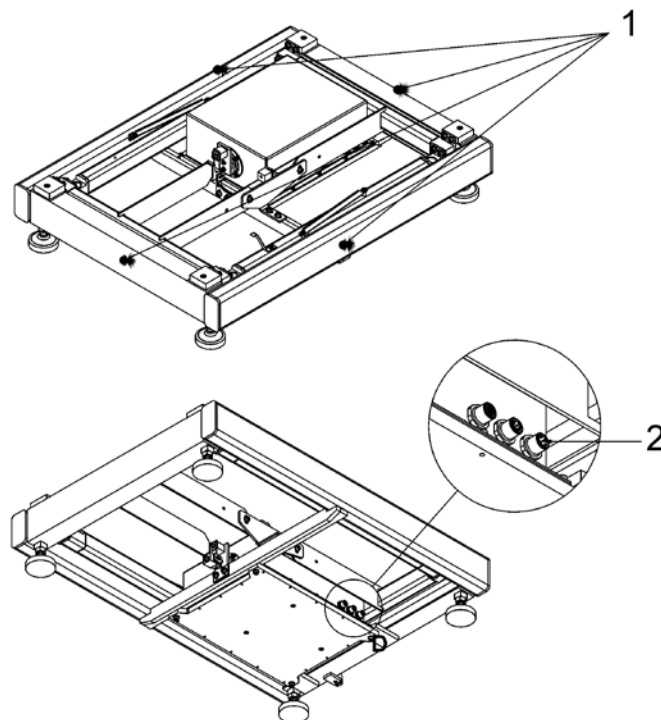

2. Connect the terminal or computer to the weighing module.
3. Install weighing pan receivers, fit them into lever seats.

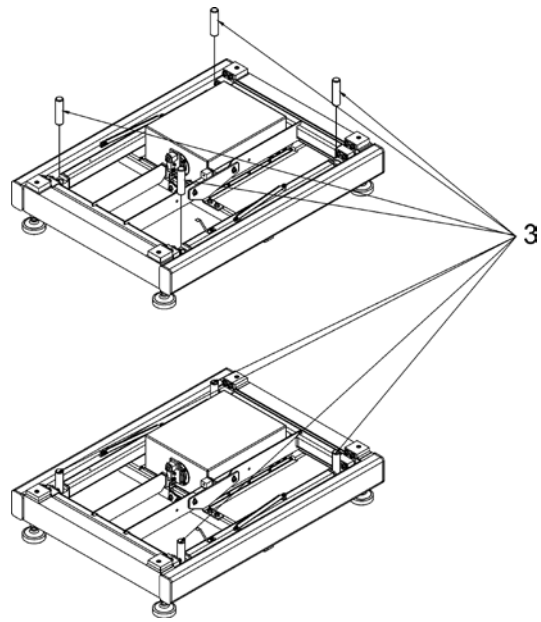

4. Disassemble transport lock by undoing screws and removing fixing washers.

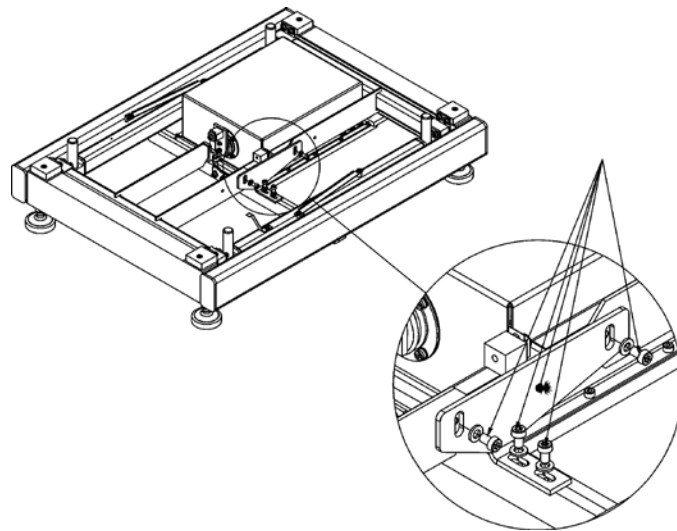

5. Install the weighing pan.

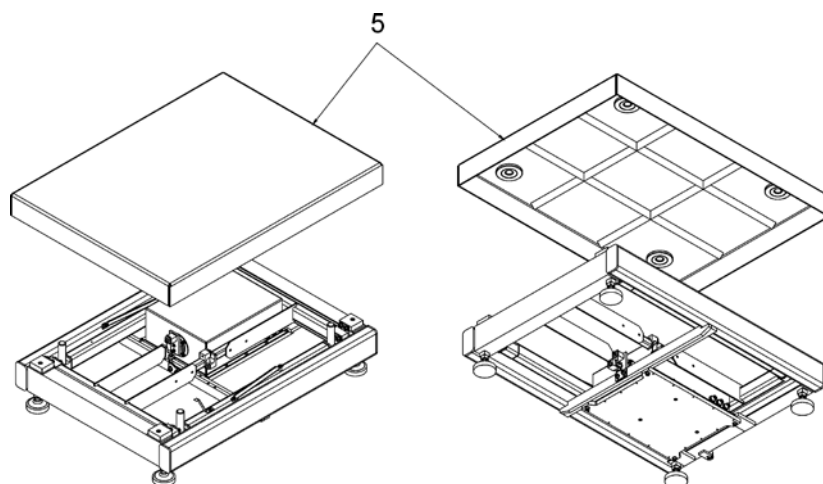

6. Place the device on a flat and even surface. Keep it far away from any sources of heat.
7. Level the device, to do it turn its feet left/right. Keep turning the feet until the air bubble takes central position.



### 3.2.2. HRP 1000 Mass Comparator Unpacking

1. Take the platform out of the packaging. Hold only the 'EXTERNAL FRAME'.

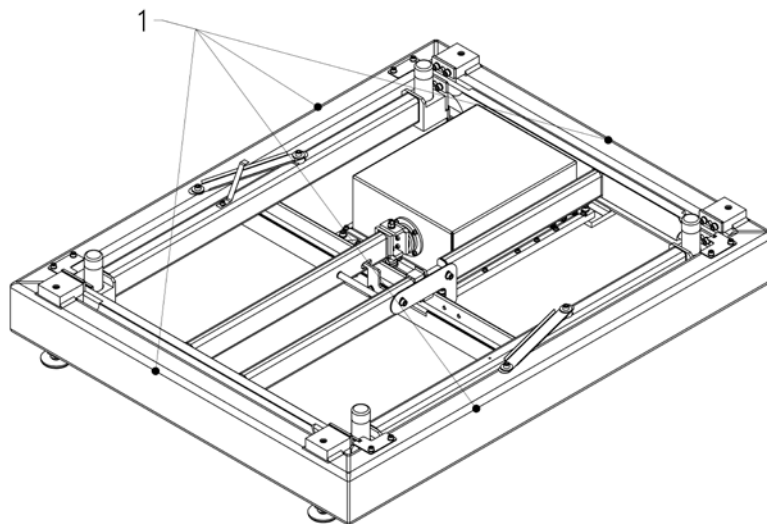

2. Connect the terminal or computer to the weighing module (3).

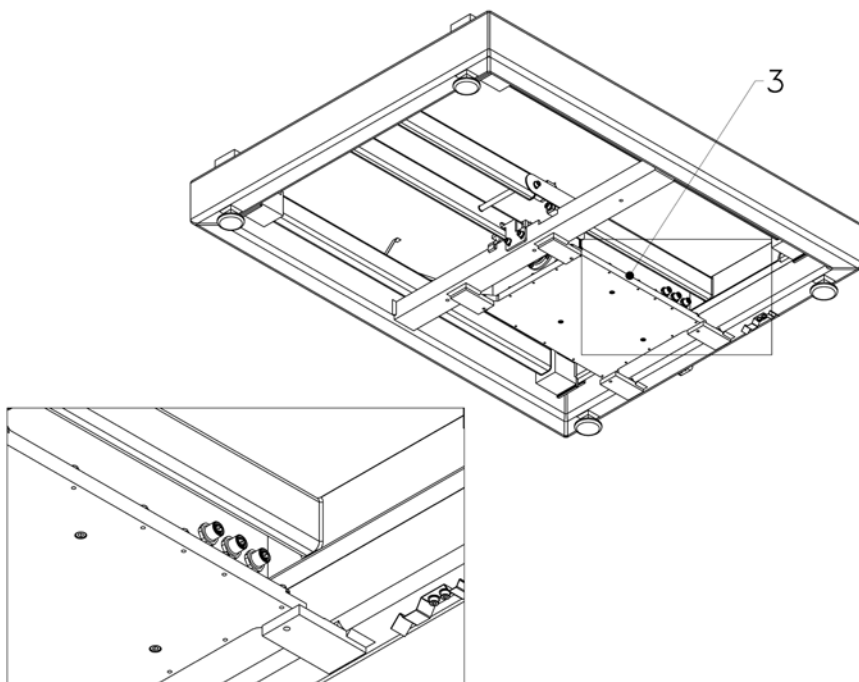

3. Install weighing pan receivers (4), fit them into lever seats (5).

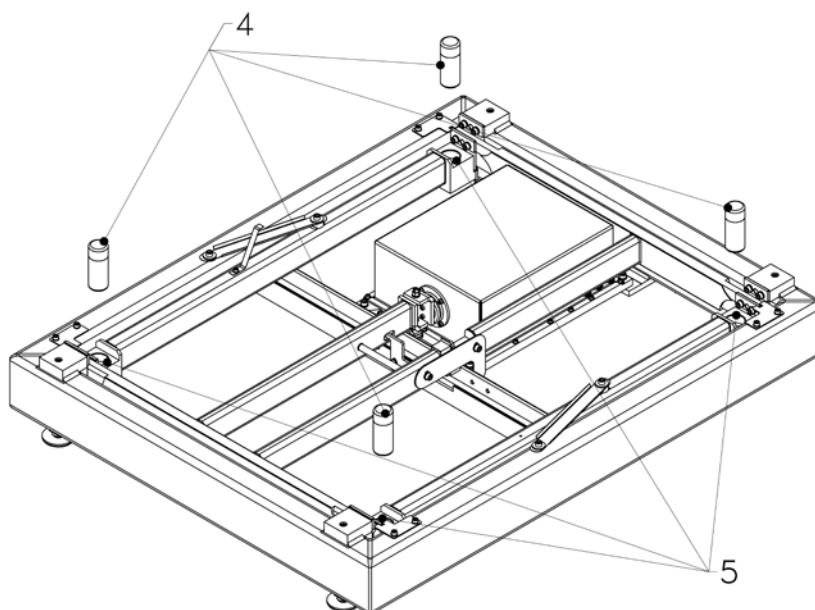

4. Disassemble transport lock by undoing screws and removing fixing washers (6).

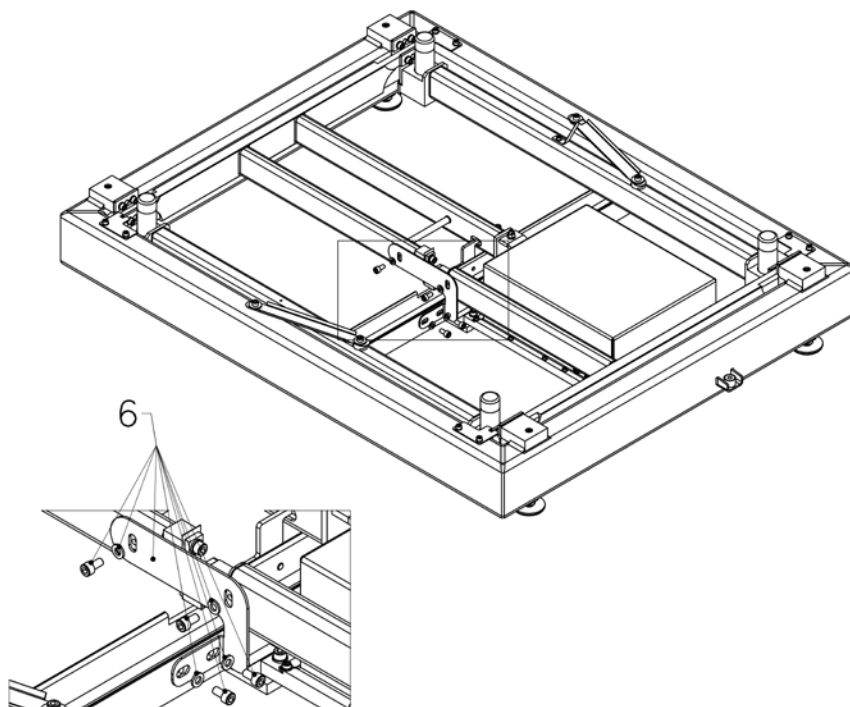

5. Install the weighing pan (7).

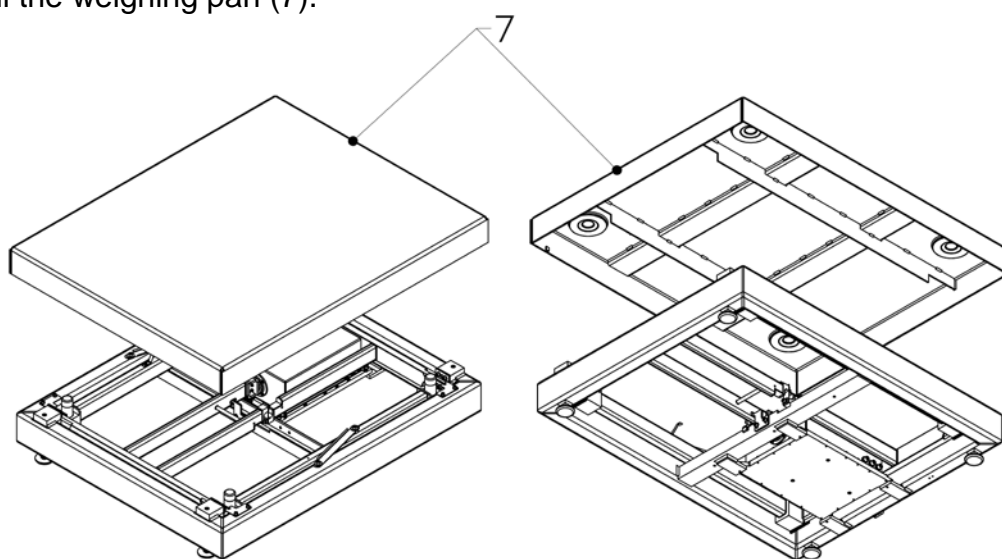

6. Place the device on a flat and even surface. Keep it far away from any sources of heat.

7. Level the device, to do it turn its feet left/right. Keep turning the feet until the air bubble takes central position.



Poziomowanie  
prawidłowe



Poziomowanie  
nieprawidłowe

### 3.2.3. HRP 2000 Mass Comparator Unpacking

1. Take the mass comparator out of the packaging using hoist. Procedure:
  - Unscrew 4 screws (1) presented in the figure below.

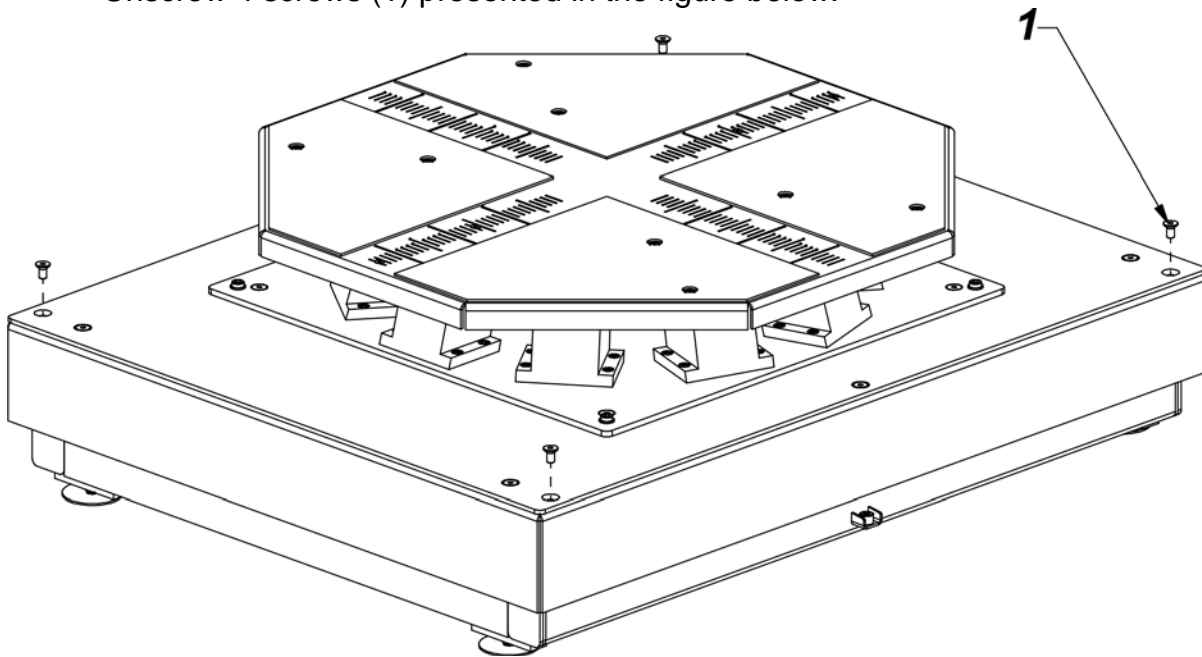

- Screw 4 screws with eyelets (2). Using cords and hoist take the mass comparator out of the packaging and place in the place of use on a flat and even surface. Keep it far away from any sources of heat.

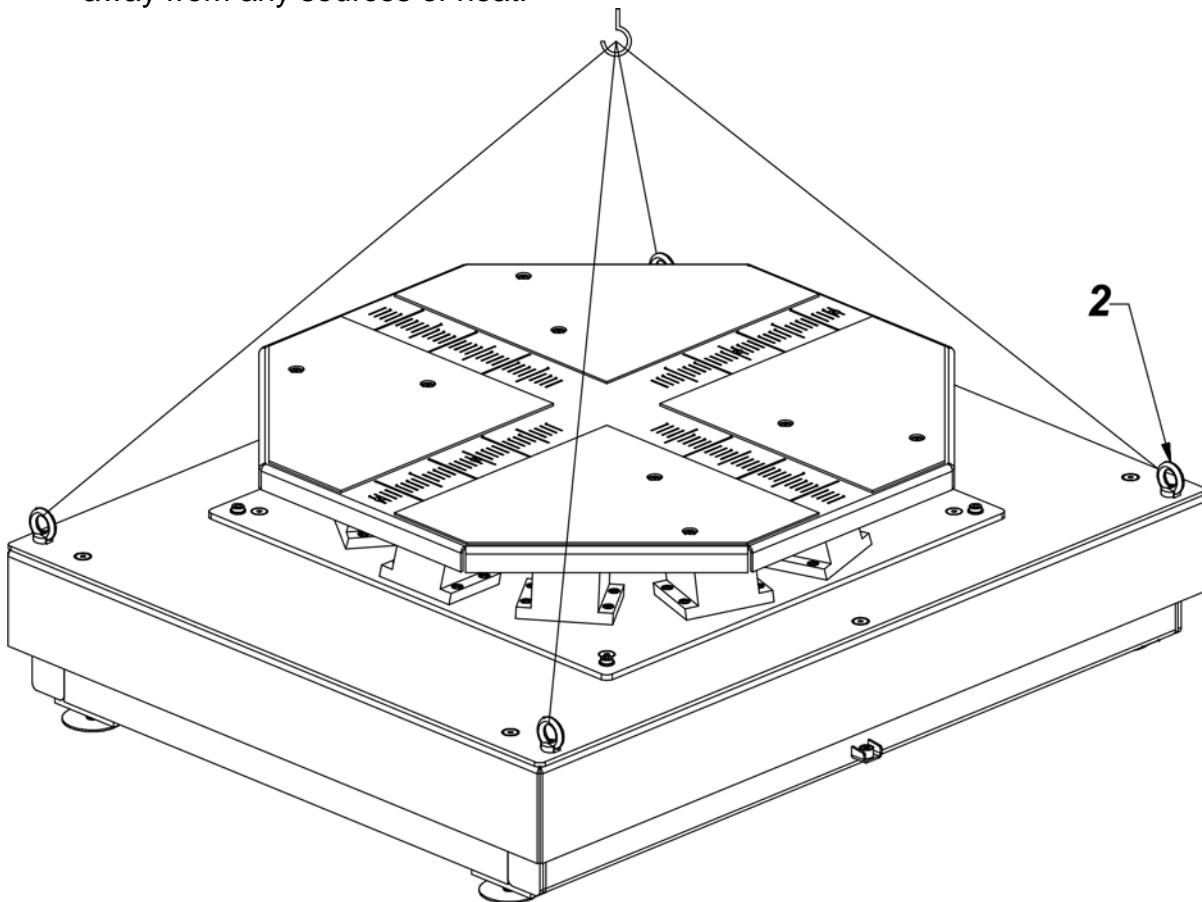

- Upon locating the mass comparator in the place of use, unscrew the screws with eyelets (1), (2) and (3).

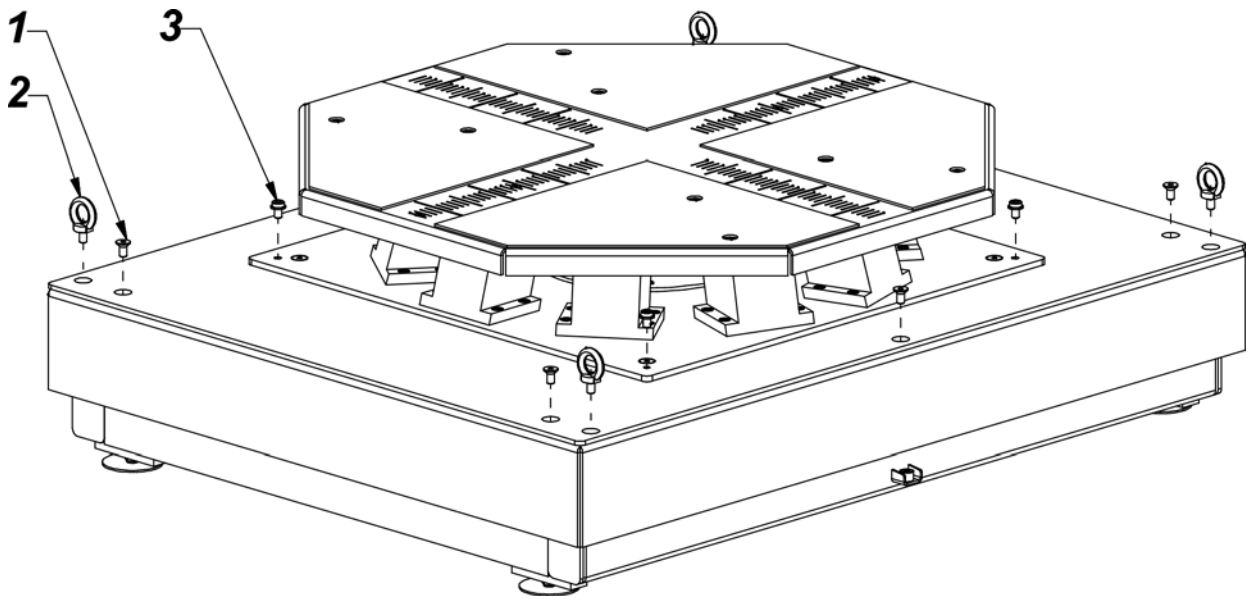

2. Replace the screws (3) with screws with eyelets (2) and using hoist cords disassemble the weighing pan plate (4).

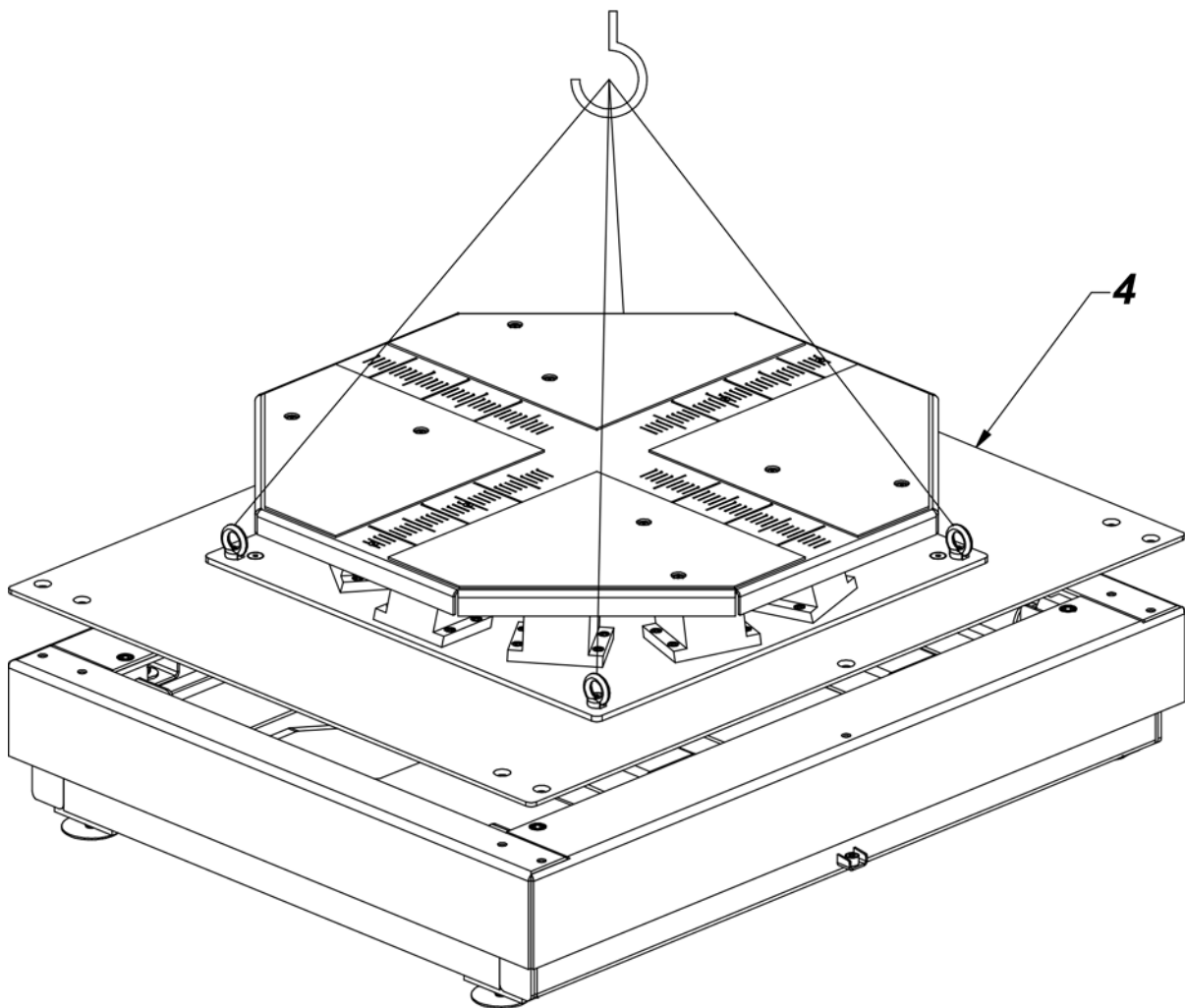

3. Connect an indicator or a computer to the weighing module.

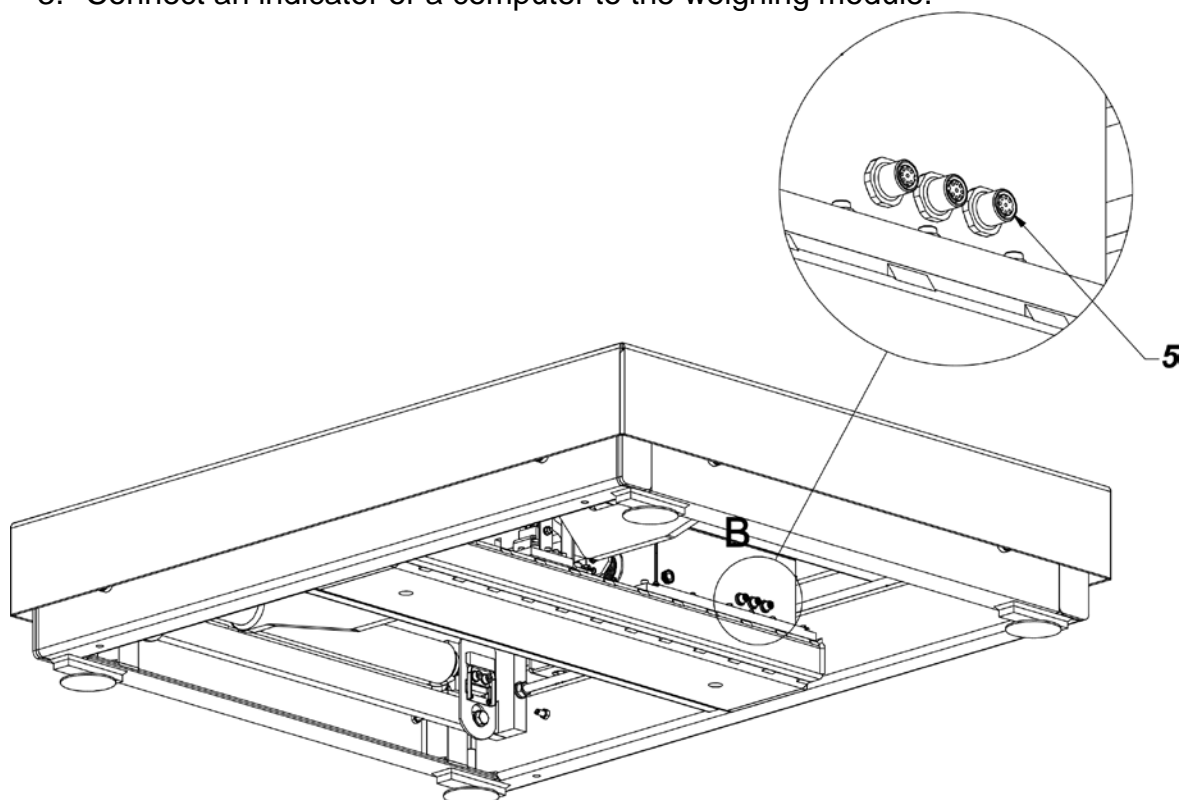

4. Disassemble transport interlocks.

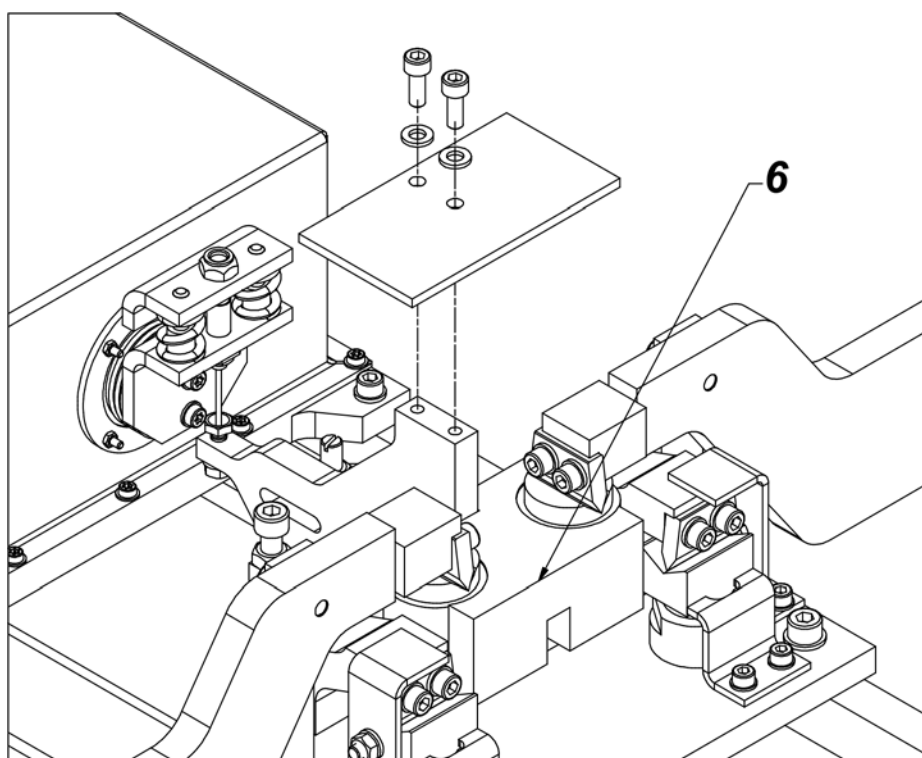

5. Set the bumpers. Loosen the nuts in all four corners. Unscrew the screws and set 1 mm gap. Tighten the nuts.



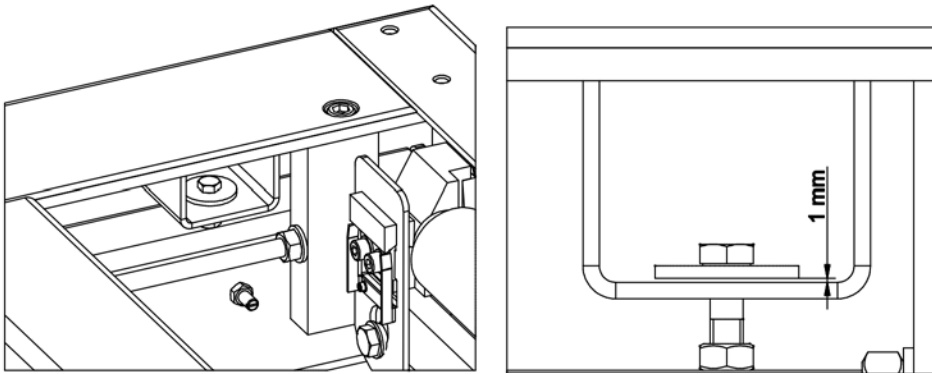

6. Level the mass comparator:  
Screw foot no. 3 so that feet no. 1, 2, 4 form a plain surface on which mass comparator frame is based.

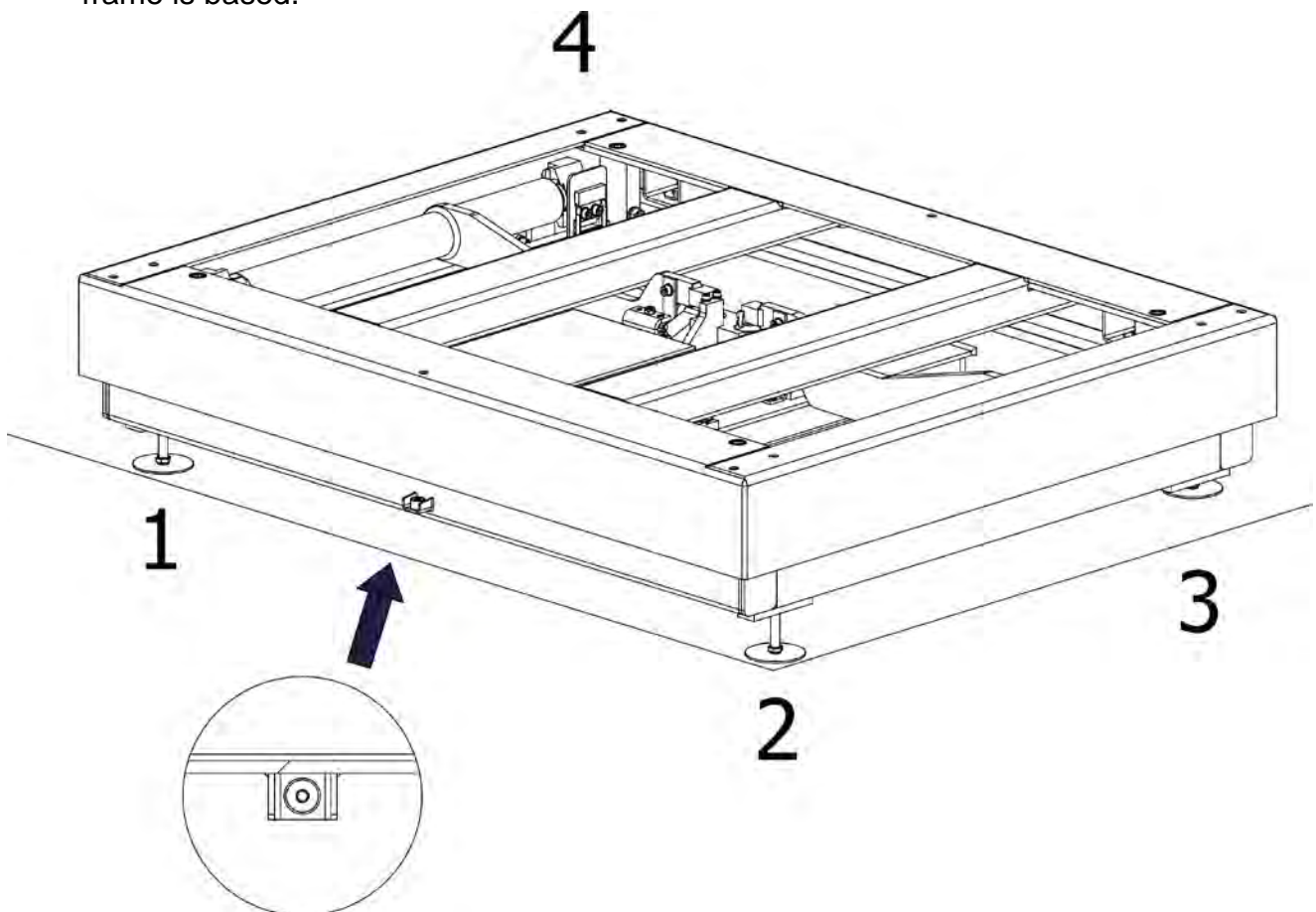

Level the platform using feet no. 1, 2 and 4 until the air bubble takes central position.

Unscrew foot no. 3 so that it rests on the ground. Do not exert stress on platform frame. Do not change the level of the mass comparator (the air bubble has to remain in central position).

7. Install the weighing pan and screw it to the mechanical design.

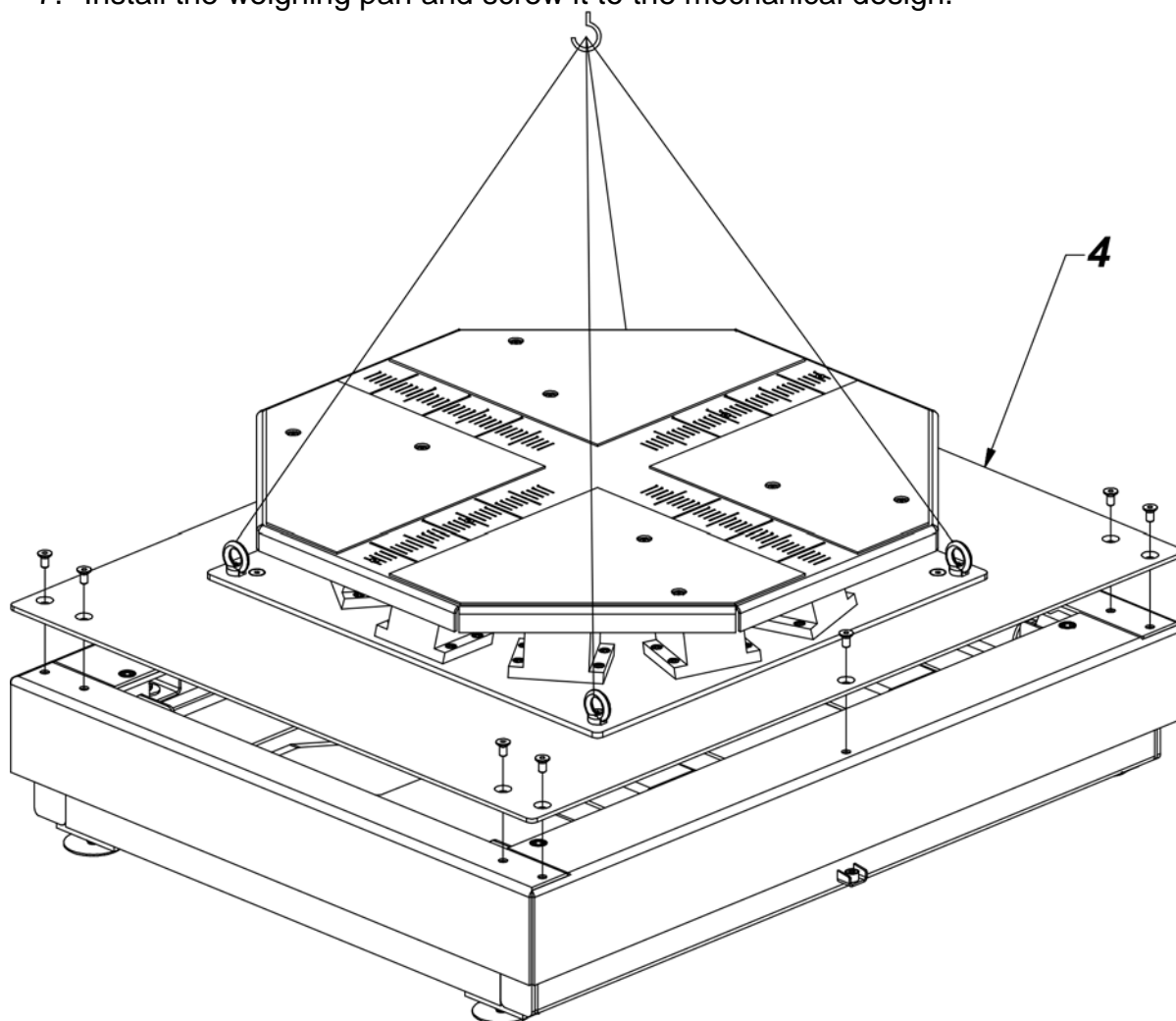

10. Turn on the power.

### 3.3. Maintenance Activities

**Caution:**

*Cleaning weighing pan while still installed may cause damage of the measuring system.*

1. Disassembly a weighing pan and other detachable components. Be careful so as not to damage the mechanism.
2. Using handheld vacuum cleaner remove dust from the weighing pan.

Cleaning powder-coated components:

*For preliminary cleaning stage you need running water or wet sponge featuring large holes, this will help you to remove loose, heavy dirt.*

*Do not use cleansers containing abrasive substances.*

*Next using cloth and cleanser-water solution (soap, dishwashing liquid) gently rub the cleaned surface.*

*Avoid using cleanser without water since it may result with damage of the cleaned surface, please mind that large amount of water mixed with cleanser is a must.*

#### Cleaning aluminium components:

*While cleaning aluminium components use products acid by nature, e.g. spirit vinegar, lemon. Do not use abrasive substances. Avoid using hard brush, this may cause scratches. It is recommended to use microfiber cloth.*

*While polishing the surface use circular movements. Use clean, dry cloth to make the surface shine.*

#### Cleaning stainless steel components:

*Avoid using cleansers containing any corrosive chemicals, e.g. bleach (containing chlorine). Do not use abrasive substances. Always remove the dirt using microfiber cloth to avoid damage of protective coating.*

*In case of a daily maintenance:*

- 1. Remove the dirt using cloth dipped in warm water.*
- 2. For best results, add a little bit of dishwashing detergent.*

#### Cleaning ABS components:

*To clean dry surfaces and avoid smudging, use clean non-colouring cloths made of cellulose or cotton. You can use a solution of water and detergent (soap, dishwashing detergent, glass cleaner). Gently rub the cleaned surface and let it dry. Repeat cleaning process if needed.*

*In the case of hard to remove contamination, e.g.: residues of adhesive, rubber, resin, polyurethane foam etc., you can use a special cleaning agents based on a mixture of aliphatic hydrocarbons that do not dissolve plastics. Before using the cleanser for all surfaces we recommend carrying out tests. Do not use cleansers containing abrasive substances.*

### **3.4. Connecting the Weighing Instrument to the Mains**

The mass comparator can be connected to the mains only with a power supply that comes standard with a particular model. Nominal voltage of the power supply (specified on the power supply data plate) has to be compatible with the power from the mains.

Plug the mass comparator to the mains, i.e. connect the power supply to the socket first, next connect its connector to a port located at the back of the comparator housing.

### **3.5. Temperature Stabilization Time**

Before start of the measuring processes, it is necessary to wait until the mass comparator reaches thermal stabilisation.



For mass comparators that were stored in much lower temperatures than the workroom temperature, before being plugged to the mains must be subjected to thermal stabilisation that shall take at least 12 hours. During the thermal stabilization, the indications on the screen can change. Potential workroom temperature change shall occur gradually and slowly in the course of the weighing instrument operation.

### **3.6. Connecting Additional Hardware**

Use only accessories and peripheral equipment recommended by the manufacturer. The mass comparator must be disconnected from the mains before connecting or disconnecting any

peripherals (printer, PC computer, computer keyboard). Upon connecting the peripherals, plug the comparator to the mains.

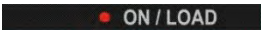
#### 4. START-UP

- Upon connecting the mass comparator to the mains, ON/LOAD diode  located on the indicator housing is backlit.
- Press  key located on the top of the operation panel. Within a few seconds the OS Windows and RADWAG software start loading, it is signalled by flickering ON/LOAD red diode.
- Upon completed start-up, the home screen is displayed automatically.
- The mass comparator runs with no operator logged in. In order to start operation it is necessary to carry out the logging procedure (for detailed logging procedure read later sections of this user manual).

**Caution:** Before you start the mass comparator, make sure that there is no load on the weighing pan.

#### 5. OPERATION PANEL

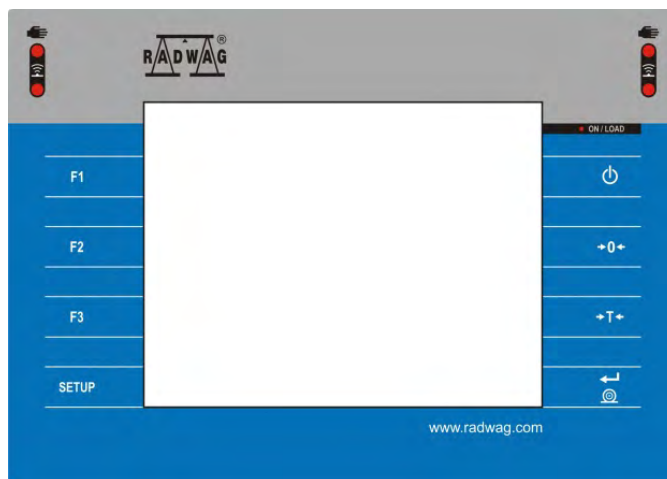

##### Key



Press to switch the mass comparator ON/OFF



Press to zero the mass comparator



Press to tare the mass comparator



Press to send measurement to a printer or a computer

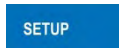

Press to enter the main menu



Programmable key, press to select working mode



Programmable key, press to select operator profile

















Programmable key, press to start an internal adjustment

#### 6. PROGRAM

Program menu is divided into function groups. Function group is a group of interrelated parameters. For detailed description of each menu group read the next sections of this user manual.

### Function Groups:

Mass comparator's main menu is accessed by pressing SETUP function key or  button located in the bottom part of the display. The menu comprises parameters referring to mass comparator settings, functions and profiles.

 ADJUSTMENT	 OPERATORS	 PROFILES
 DATABASES	 COMMUNICATION	 PERIPHERALS
 INPUTS/OUTPUTS	 PERMISSIONS	 MISCELLANEOUS
 AMBIENT CONDITIONS	 UPDATE	 ABOUT
 VIDEOS		

## 7. WEIGHING RESULT WINDOW

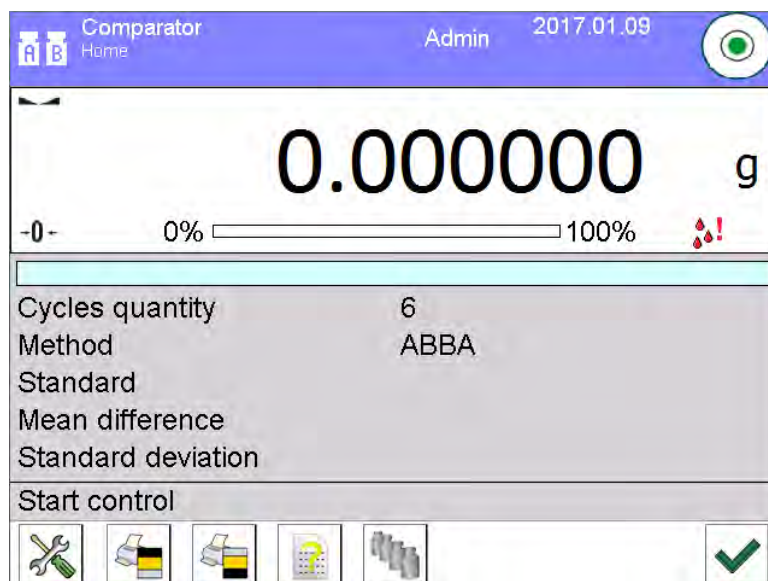

Comparator Home Admin 2017.01.09

0.000000 g

-0- 0% 100%

Cycles quantity 6  
Method ABBA  
Standard  
Mean difference  
Standard deviation

Start control

## The home screen features 4 sections:

- Top section displaying data on active working mode, logged operator, date, time, active connection to a computer and current level status of a mass comparator.



- Section presenting the weighing result and a current measuring unit.

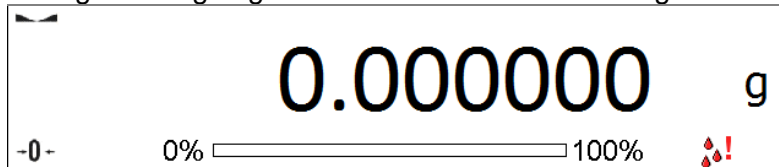

- Grey workspace containing additional data on currently carried out activities.

Cycles quantity	6
Method	ABBA
Standard	
Mean difference	
Standard deviation	
Start control	

### Caution:

Data contained in the workspace is freely configurable. For detailed instruction refer to section 10.16 of this user manual.

- Workspace with set of function buttons:



### Caution:

You can define the on-screen function buttons. For detailed instruction refer to section 10.16 of this user manual.

## 8. LOG IN OPERATION

In order to access operator-related parameters and in order to edit databases, you need to log in as an operator with **<Administrator>** permissions.

### Log in operation

- Go to home screen, press **<Log in>** button, wait for the operators database and **<Admin>** entry to open.
- Select **<Admin>** operator, Wait for the on-screen keyboard with a password box to open.
- Enter „1111” password and press  button to confirm.
- The home screen is displayed, **<Log in>** sign is replaced by **<Admin>** sign.
- When logged, add operators and set the permissions (for detailed procedure read section 12 and 13).

While Logging In again, select an operator from the list and enter the password, the software initiates operation with permissions set for the selected operator.

**Log out operation**

- Go to home screen, press logged operator name, wait for the operators database to open.
- Select **<Log out>** option (1st position on the operators list).
- Home screen of the software and **<Log in>** sign are displayed again automatically.

**9. OPERATING THE MENU**

Operation of mass comparator software menu is intuitive and uncomplicated. The touch panel makes the software operation easy. Pressing a function button or an area on the display initiates an assigned function or process.

**9.1. Buttons**

	<p>or  Press to enter home screen</p> <p> Press to scroll the menu 'up'</p> <p> Press to scroll the menu 'down'</p> <p> Press to scroll the menu 'up-down' fast</p> <p> Press to confirm modifications</p> <p> Press to abort modifications</p> <p> Press to add a new record to a database</p> <p> Press to search for a particular record in a database by date</p> <p> Press to search for a particular record in a database by name</p> <p> Press to search for a particular record in a database by code</p> <p> Press to print out a particular record from a database</p> <p> Press to clear the editing field</p> <p> Press to enable/disable an on-screen keyboard</p> <p> Press to read printout template from a file format *.lb (function key is active on inserting a USB flash drive to terminal's USB port)</p> <p> Press to select variables for a printout from a list</p> <p> Press to move (exit) one level up</p>
--	---

**9.2. Return to the Comparison Mode**

Any changes made in mass comparator's memory are automatically saved upon returning to the home screen. To return to the home screen:

**Procedure:**

- Press button repeatedly, keep pressing the key until you see the home screen.

- Press  button, the home screen is displayed immediately.

## 10. COMPARISON

Load the weighing pan with test weight. Upon displaying  marker on the left, you can read weighing result.

### 10.1. Selecting Comparison Unit

Change of comparison unit is carried out by pressing the weighing unit pictogram visible next to the value of measurement result. Upon pressing the weighing unit, list of available units is displayed. Select the unit you need, the software automatically recalculates indicated value.



Options:

<i>unit</i>	<i>denotation</i>	<i>unit</i>	<i>denotation</i>
gram	[g]	Taele Singapore	[tls]
milligram	[mg]	Taele Taiwan	[tlt]
carat	[ct]	Taele China	[tlc]
pound	[lb]	Momme	[mom]
ounce	[oz]	Grain	[gr]
ounce Troy	[ozt]	Newton	[N]
pennyweight	[dwt]	Tical	[ti]
Taele Hongkong	[tlh]		

### 10.2. Correct Comparison Principles

To assure long-term operation and correct comparison of the weights, follow the rules presented below:

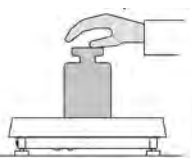
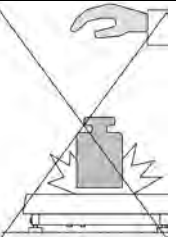
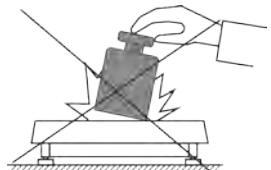
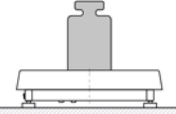
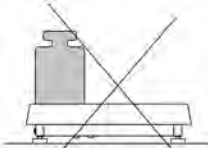
- Remember to run the mass comparator with unloaded weighing pan

YES	NO	NO	YES	NO
				
Avoid applying mechanical shocks to the weighing pan.			Place weighed loads centrally on the weighing pan:	
NO	NO			
				
Avoid side loading, in particular side shocks:				





### 10.3. Mass Comparator Levelling

The mass comparator features AutoLEVEL System, which continuously monitors its level status. The level status is signalled on the top of the display and on detecting any change it indicates appropriate information and/or starts an alarm. As a result, a window for adjusting the level is displayed.

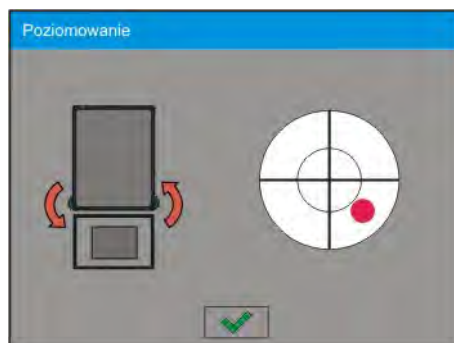

#### Procedure:

- Press level status  pictogram located on the top of the display.
- Control panel of levelling function is displayed. It features level status and an image of mass comparator.





- Level the mass comparator, to do it turn the feet in a way indicated by blinking  pictograms on the display – the level point moves towards the centre of the level circle.
- As the level point takes central position, its colour changes from red to green – which is a confirmation for correct level status.

### 10.4. Zeroing

To zero mass indication, press  key. Zero indication and the following pictograms are displayed:  and . Zeroing operation means determining new zero point, recognized by the weighing device as precise zero. The instrument can be zeroed only when the indication is stable.

### 10.5. Taring



To determine net weight value, load the weighing pan with a packaging, wait for a stable indication and press  key. Zero indication and the following pictograms are displayed: **Net** and . Upon unloading the weighing pan, the sum of tared masses with minus sign is displayed. You can assign tare value to a particular product stored in the database. In such case the assigned tare value is automatically acquired upon selection of the given product.

#### Caution:

*It is impossible to tare negative values. When you try to tare negative values, the weighing instrument responds with an error message: **Err3**. In such case, zero the indication and repeat taring procedure.*

#### Entering tare value manually

#### Procedure:

- Press  quick access key. The key is available regardless of the working mode you operate.
- An on-screen numeric keyboard is displayed.
- Enter tare value and press  button.
- The mass comparator returns to the comparison mode, and the display indicates entered tare value with minus „-“ sign.

## Deleting tare

The tare value indicated on the display can be deleted by pressing key on the operation panel, or by using programmable <Deactivate tare> function key.



**Procedure 1** - upon taking the tared load off the weighing pan:

- Press ZERO key,
- The NET marker gets deleted, new zero point is determined.

**Procedure 2** - with tared load on the weighing pan:



- Press ZERO key,
- The NET marker gets deleted, new zero point is determined.
- When the tare value exceeds 2% of the maximum capacity, Err message is displayed in order to inform you about the fact that operation cannot be carried out.

**Procedure 3** - when the tared load is on the weighing pan or upon taking the tared load off the weighing pan:

- Press programmable key <Deactivate tare> ,
- The NET marker is deleted.
- The display indicates tare value.
- Press <Restore tare>  key to restore the last tare value.

## 10.6. Running Working Mode

**Procedure:**



- In home screen, press  pictogram located in the top bar. <Working modes> submenu is opened, it contains list of working modes to be selected.
- Select < **Comparator**> mode. The software automatically returns to the home screen and displays name of selected working mode in the top bar.
- The following message is displayed in the work pane: <**Start control**>.
- Select internal and external loads (depending on mass comparator type) suitable for mass of calibrated standard.
- Load the weighing pan with appropriate reference weight.
- Zero/tare mass comparator indication.

## 10.7. Working Mode – Comparator

< **Comparator**> working mode enables determining standard deviation for series of measurements. Standard deviation is determined based on ABBA, ABA or AB series of measurements, where:

A – reference weight

B – test weight

You can determine quantity of measurements in a series and ABBA, ABA or AB method. To do that, enter < **Working modes**> menu and < **Comparator**> submenu.

The results are calculated on the basis of the following tables and formulas:

For ABBA series

No.	A	B	B	A	$D = B_{\text{mean}} - A$
1					$D_1$
2					$D_2$
3					$D_3$
4					$D_4$

5					$D_5$
.....					...
$n$					$D_n$

For ABA series

No.	A	B	A	$D = B - A_{\text{mean}}$
1				$D_1$
2				$D_2$
3				$D_3$
4				$D_4$
5				$D_5$
.....				...
$n$				$D_n$

For ABA series

No.	A	B	$D = B - A$
1			$D_1$
2			$D_2$
3			$D_3$
4			$D_4$
5			$D_5$
.....			...
$n$			$D_n$

Standard deviation is calculated by determining:

- ABBA and ABA differences for each measurement group:

$$D_i = \bar{B} - \bar{A}$$



- Mean value of difference between ABBA and ABA:

$$\overline{DX}_i = \frac{1}{n} \sum_{i=1}^n D_i$$

- Standard deviation:

$$s = \sqrt{\frac{1}{n} \sum_{i=1}^n (D_i - \overline{DX}_i)^2}$$

### 10.8. Selecting Measuring Method in Mass Comparator

Particular working modes settings feature specific functions. The functions enable adapting mode operation to your individual needs. Working modes can be configured in  **Working modes** submenu. Press grey area on the display to enter  **Working modes** submenu.

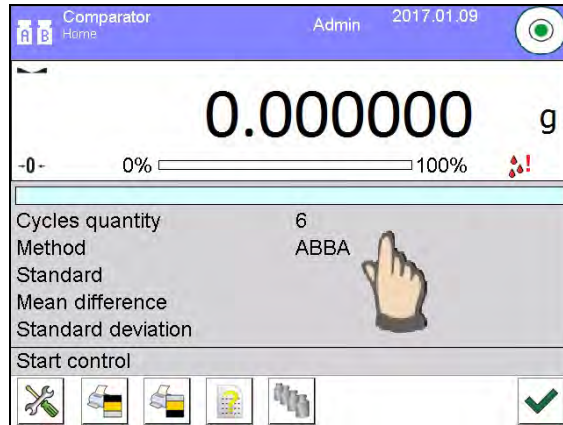

Press <  **Settings**> key, working mode edit box is displayed:

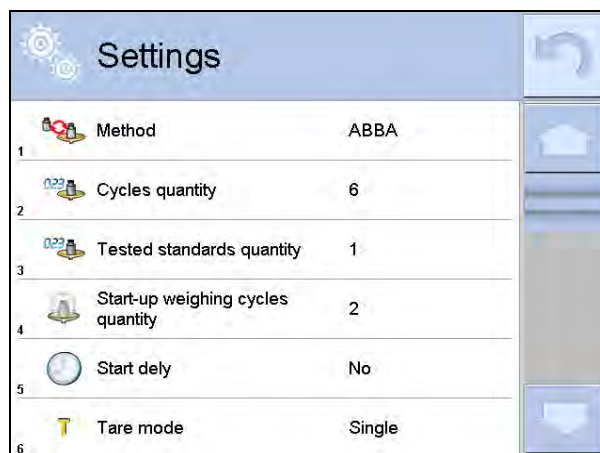







In order to change the method of weights comparison, press <  **Method**> and select method from the list:

- ABBA
- ABA
- AB





### 10.9. Determining Cycles Quantity

**Procedure:**





- Press  key, next select <  **Profiles**>
- Enter <  **Working modes**> submenu
- Select <  **Comparator**> and press <  **Settings**>
- Press <  **Cycles quantity**> key, enter the quantity of weighing cycles and press  key to confirm.

### 10.10. Determining Quantity of Start-up Weighing Cycles

**Procedure**

- Enter <  **Working modes**> submenu,
- Select: <  **Comparator**> , next <  **Settings**> and <  **Start-up weighing cycles quantity**>. Edit box < **Start-up weighing cycles quantity**> and an on-screen keyboard are displayed,
- Enter respective value and press  key to confirm.

### 10.11.Start Delay

- Enter < **Working modes**> submenu,
- Select: < **Comparator**> , next < **Settings**> and < **Start delay**>. Edit box is displayed.
- Enter respective value:
  - YES – during comparison process start, edit box is displayed for entering delay value, after this time comparison process is started automatically,
  - NO - procedure starts immediately, without delays. Upon selecting the option, edit box is closed and description next to the parameter changes.

### 10.12.Tare Mode

- SINGLE,  
mass value saved to mass comparator on single pressing of TARE key. Subsequent pressing of TARE key determines new value of tare. Selecting product or packaging to which tare value is assigned causes automatic deleting of previously assigned tare value.
- SUM OF CURRENT,  
totalizing currently entered tare values for product and packaging (resulting from products and packaging selection out of the database) with possibility to add tare value entered manually. Upon determining tare value for a product or a packaging again, the tare value introduced manually is deactivated.
- SUM OF ALL,  
totalizing of all entered tare values.
- AUTOTARE  
Means of operation:  
Each first stable measurement result is tared. The NET pictogram is displayed. You can now determine net weight. Upon unloading the weighing pan and autozeroing, Tare value is automatically deleted.

### 10.13.Printout/Enter Mode

- PRINTOUT / ENTER KEY
  - Never – printout disabled
  - First stable – first stable measurement is recorded
  - Each stable – all stable measurements are recorded
  - Each – printout of all measurements (stable and unstable), for verified mass comparator only stable measurements are printed (as in <Each stable> setting)
- AUTOMATIC MODE
  - Never – printout disabled
  - First stable - first stable measurement is registered; next stable measurement is registered after unloading the weighing pan, returning the indication to the value below set threshold value and loading the weighing pan again with next weight.
  - Last stable - last stable measurement is registered. The record takes place upon unloading the weighing pan and returning the indication to the value below set threshold value.  
With interval – interval for sending the indication to be printed out.
- THRESHOLD  
Mass value obligatory for operation of automatic printout, set in grams.
- INTERVAL  
Printout interval.
- PRINT REPORT
  - Yes – automatic printout upon completed calibration procedure
  - No - printout disabled

## 10.14. Printouts

This option enables determining standard and non-standard printouts.

- **Standard printout**

Comprises four internal sections containing different variables. For each variable set option YES to include it in a standard printout. If option NO is selected, then the variable is disabled, i.e. it is not printed.

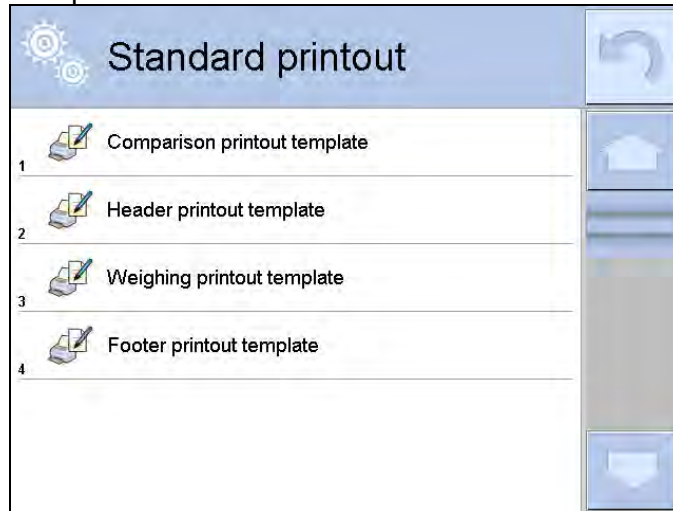

Upon pressing <Comparison printout template>, editing box for determining printout content is displayed.

Printout content:

- Working mode
- Operator
- Report number
- Start date
- End date
- Task
- Order number
- Test weight number
- Reference weight
- Mass
- Weight class
- Measurements
- Mean difference of mass of reference and test weight
- Standard deviation
- Cycles quantity
- Method
- Min temperature during process
- Max temperature during process
- Min humidity during process
- Max humidity during process
- Min pressure during process
- Max pressure during process
- Empty line
- Dashes



- Signature
- Non-standard printout

### 10.15.Completed Comparison Processes Report

Upon each completed comparison process report is generated. The report is saved to **<Comparison reports>** database. The files are named by the date and time (hour) of mass comparison process.

Report template:

*Report number C/31/10/11/11/43*  
*End date 2017.05.28 11:44:46*  
*n |A |B |A |D*  
*1 |0.000 |0.131 |0.001 |0.1305*  
*2 |0.002 |0.130 |0.003 |0.1275*  
*3 |0.004 |0.131 |0.004 |0.127*

*Mean difference 0.12833 g*  
*Standard deviation 0.00189 g*

*Method ABA*



-----

Signature

.....

### Using information from header and footer.



If this information is to be used:

- Press <  Header printout> prior the procedure
- Carry out the procedure
  - Report is printed out automatically upon the last measurement result has been entered
  - The report can be printed out multiple times upon pressing <  **PRINT** > key.
- Press <  Footer printout> upon procedure completion.

### 10.16.Display Arrangement

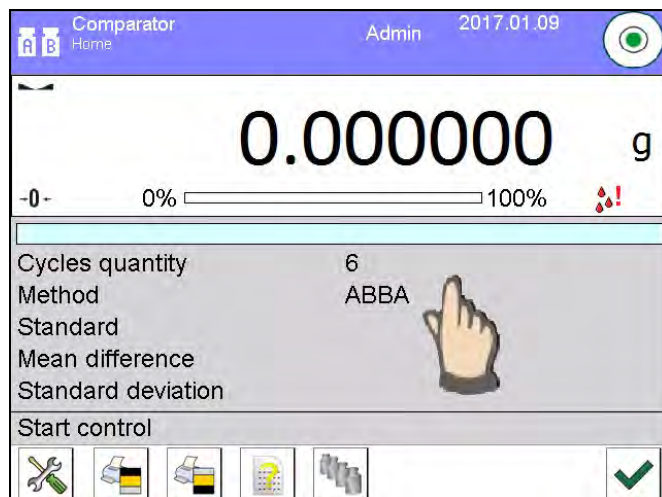
You can select information and quick access keys that are to be displayed. In order to arrange the display, press information area:



Next press Information  or Keys  pictogram depending on how you want to configure information or quick access keys. Information to be displayed:

- Cycles quantity
- Method
- Comparison procedure
- Test weight
- Reference weight
- Measurement
- Difference
- Mean difference
- Standard deviation
- Ambient conditions
- Supplementary unit









Press Yes to activate Information selected from displayed edit box.

Follow the same procedure to select quick access keys. Upon selecting access key out of the list displayed in edit box, pictogram of function assigned to the quick access key is displayed next the key number.

### 10.17. Mass Comparison Process - Basic Procedure

1. Select comparison method and set parameters of mass comparator working mode by pressing grey area on the display and  pictogram.

#### Working Modes - Comparator

<i>Pictogram</i>	<i>Overview</i>	<i>Value</i>
	Mass comparator	-
	Method	ABBA
	Cycles quantity	n
	Start-up weighing cycles quantity	2
	Start delay	YES/NO
	Tare mode	Single
	Printout/Enter key	
	Printout	Standard printout



2. Press  button located in the bottom part of the display and follow the prompts
  3. The following information is displayed:  
 <1/n cycles quantity> - first cycle out of „n” cycles.  
 <Load A1-1> - load **A1** weight for the first time in the cycle
  4. Load the weighing pan with **A1** weight. Upon indication stabilization press  button to confirm.
  5. Message <Load B1-1> is displayed.
  6. Unload **A1** weight.
  7. Message <-Wait-> is displayed. Mass comparator waits for **B1** weight to be loaded for the first time (description in the information bar)
  8. Load the weighing pan with **B1** weight. Upon indication stabilization press  button to confirm.
  9. Message <Load B1-2> is displayed.
  10. Unload **B1** weight.
  11. Message <-Wait-> is displayed. Mass comparator waits for **B1** weight to be loaded for the second time (description in the information bar) – only when ABBA method is selected
  12. Load the weighing pan with **B1** weight. Upon indication stabilization press  button to confirm.
  13. Message <Load A1-2> is displayed.
  14. Unload **B1** weight.
  15. Message <-Wait-> is displayed. Mass comparator waits for **A1** standard to be loaded for the first time (description in the information bar)
  16. Load the weighing pan with **A1** weight. Upon indication stabilization press  button to confirm.
  17. Description in the information field changes to <2/n cycles quantity> - this is an information about switching to the next cycle
  18. Follow the same steps as for the first cycle to complete the procedure.
  19. The process is completed automatically by printing out comparison process report. The report is automatically saved to reports database.
- You can finish comparison process or repeat it.

## 11. ADJUSTMENT

Mass comparators feature automatic internal adjustment system which ensures correct measurement accuracy.  <ADJUSTMENT> menu contains functions that enable controlling operation of mass comparator adjustment process.

### 11.1. Internal Adjustment

Internal adjustment is carried out by means of an internal adjustment weight. <Internal adjustment> button, when pressed, automatically triggers adjustment process. Upon adjustment process completion respective message, informing about process end and about its status, is displayed.





#### **Caution:**

*Mass comparator adjustment procedure requires stable conditions (no air drafts, no vibrations), the weighing pan must be unloaded in the course of adjustment.*

## 11.2. External Adjustment

External adjustment is carried out using an external mass standard of the right accuracy and weight value, which value depends on mass comparator type and capacity. Correction is carried out semi-automatically, successive process stages are signalled with prompts.

### Procedure:

- Enter <Adjustment> submenu, next select  External adjustment> parameter.
- Message to remove weight is displayed. Unload the weighing pan and press  button. Whereas mass comparator determines start mass, **Start mass determination** message is displayed.
- Upon completed start mass determination procedure, message to load the weighing pan is displayed along with particular mass standard value. Load the weighing pan and press  button.
- Upon completed procedure, unload the weighing pan and press  button to confirm. Mass comparator returns to the comparison process.

## 11.3. User Adjustment

User adjustment can be carried out using any adjustment weight mass of which ranges between 0.15 Max and Max. User adjustment and external adjustment procedures are likewise with one exception, before user adjustment start, an edit box for entering mass of the used adjustment weight is opened.

In order to start user adjustment, enter <Adjustment> submenu and select <  User adjustment> option. Then follow the commands displayed on a screen.

## 11.4. Adjustment Test

<Adjustment test> function enables comparing the result of an internal automatic adjustment with the value recorded in mass comparator factory parameters. The comparison is used for determining mass comparator sensitivity drift over time.

## 11.5. Automatic Adjustment

Enter this menu to specify conditions initiating an automatic adjustment. Options:

- None – automatic adjustment inactive.
- Time – adjustment takes place in time intervals declared in menu <Automatic adjustment time> (10.6),
- Temperature – adjustment is triggered by temperature change.
- Both – adjustment is triggered by both, temperature changes and time.

## 11.6. Automatic Adjustment Time

 <Automatic adjustment time> parameter determines time interval between successive automatic internal adjustments. The time interval is declared in hours and ranges between 1 and 12 hours.

To set time interval for automatic adjustment:



- Select <Automatic adjustment time> option.
- Using displayed menu, select appropriate time interval (given in hours) which is to elapse between the most recent adjustment and activation of the following automatic internal adjustment.

## 11.7. Scheduled Adjustments

 Scheduled adjustments parameter allows you to precisely specify time for adjustment performance and interval between successive adjustments. The parameter is not connected with automatic adjustment and its criteria (time, temperature). You can schedule when internal and external adjustment shall be performed. In order to design schedule for external adjustment, it is necessary to record mass standards for adjustment performance into mass comparator memory.

### Procedure:

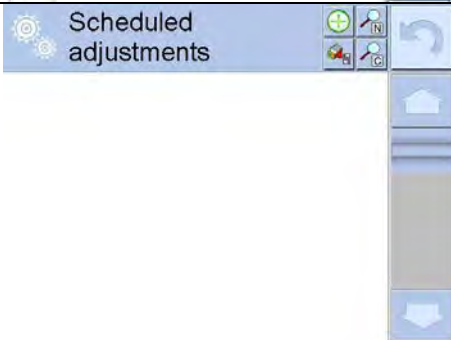
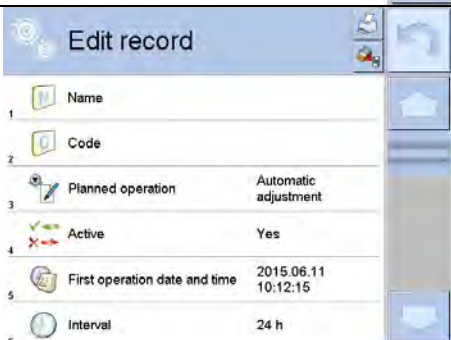
Prior setting adjustment schedule, enter data of mass standards intended for external adjustment performance.

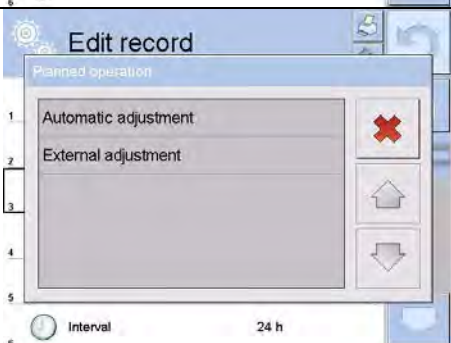
	<p>Enter operator menu, select &lt;Adjustment&gt; submenu and find &lt;Scheduled adjustments&gt; parameter.</p>
	<p>Enter &lt;Scheduled adjustments&gt; parameter, wait for 'Scheduled adjustments' window to open, add adjustment procedures. Remember, only Administrator can add new positions.</p>
	<p>In order to add a new position, press  button, wait for a window with data on scheduled adjustment to open.</p>
	<p>Select task: automatic adjustment (internal or external).</p>

<p><b>Edit record</b></p> <p>1 Name TEST 01</p> <p>2 Code 123456</p> <p>3 Planned operation Automatic adjustment</p> <p>4 Active Yes</p> <p>5 First operation date and time 2015.06.11 10:12:15</p> <p>6 Interval 1 h</p>	<p>For automatic adjustment option, enter data on the adjustment and its schedule.</p>
<p><b>Edit record</b></p> <p>2 Code 654321</p> <p>3 Planned operation External adjustment</p> <p>4 Adjustment weight ETALON 01</p> <p>5 Active Yes</p> <p>6 First operation date and time 2015.06.11 11:00:00</p> <p>7 Interval 24 h</p>	<p>For external adjustment option, enter data on the adjustment, mass standard used for the adjustment performance and its schedule.</p>
<p><b>Scheduled adjustments</b></p> <p>1 TEST 01</p> <p>2 TEST 02</p>	<p>When all necessary data has been introduced, return to the previous window. The window features newly added position relating to scheduled adjustment procedure.</p>



Upon entering all data exit the menu.

Now all the adjustments are carried out automatically as scheduled and with specified time intervals.

### 11.8. Adjustment Weights

<Adjustment weights> parameter determines features of weights used for adjustment process.

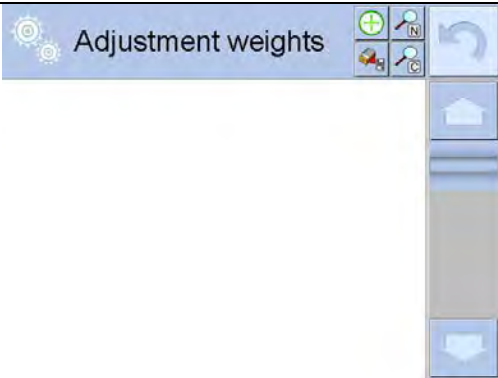
<p><b>Adjustment</b></p> <p>7 Scheduled adjustments</p> <p>8 Adjustment weights</p> <p>9 Report printout No</p> <p>10 GLP project</p> <p>11 Adjustment history</p>	<p>Enter operator menu, select &lt;Adjustment&gt; submenu and find &lt;Adjustment weights&gt; parameter.</p>
--	--

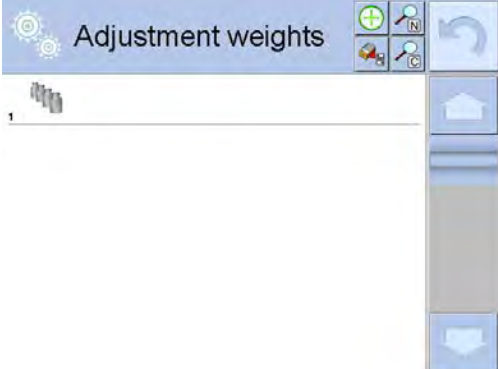
	<p>Enter &lt;Adjustment weights&gt; parameter, wait for 'Adjustment weights' window to open, add adjustment weights. Remember, only Administrator can add new positions.</p>
	<p>In order to add a new position, press  button, wait for a window with data on defining adjustment weight to open. Fill in all the fields in accordance with the adjustment weight features.</p>
	<p>When all necessary data has been introduced, return to the previous window. New adjustment weight is added.</p>

## 11.9. Report Printout



<  Report printout > parameter determines whether or not an adjustment report is to be automatically printed upon adjustment process completion.

In order to set automatic report printout, go to <  Report printout > parameter and select <YES> value.

## 11.10. GLP Project

GLP is one of many methods for documenting work in accordance with adopted quality system. Data selected for printing is printed on each release of an adjustment report.

Information and signs to be used in a GLP report:

- Adjustment
- Working mode
- Date
- Time
- Mass comparator type
- Mass comparator S/N
- Operator
- Name and surname
- Level status
- Nominal mass

- Current mass
- Difference
- Temperature
- Dashes
- Empty line
- Signature
- Non-standard printout

### 11.11.Adjustment History

Adjustment history contains data on all carried out adjustment processes. The record is carried out automatically. Each record on adjustment comprises basic data on completed process. This menu enables displaying the list of completed adjustment processes. Each report is printable. In order to print an adjustment report, enter <Adjustment> submenu, next enter <Adjustment history>, select adjustment to be printed. Upon displaying record details, press  print key located on the top of the display.

#### **Caution:**

*If the mass comparator memory is full then the oldest record gets automatically deleted.*

If internal procedures of an organization require maintaining complete documentation from all carried out adjustment processes, then the list with adjustment records has to be printed and archived periodically.

#### **Searching for adjustment record**

Mass comparator enables searching for a specific completed adjustment record. To do that, press  search pictogram and enter date of adjustment process that is to be found.

#### **Exporting data on completed adjustment process**

Connect a USB flash drive to mass comparator's USB port. Press <Data export> button located on the top of the display. The process is fully automatic and on its completion a file with **.db.** extension is saved on a USB flash drive connected to the USB port.

## 12. OPERATORS

'Operators' menu contains list of operators authorized to operate the mass comparator. The following data can be defined for each mass comparator operator:

- Name
- Code
- Password
- Name and surname
- Permissions
- Account active
- Language
- Default profile
- Card no.

#### **New operator can be added by the Administrator exclusively.**

Procedure:

- Enter <Operators> menu, press <Add>  button.
- Define all necessary data.



**Caution:**

It is possible to search for an operator in a database of operators by code or name.

**Edit data** on an operator:

- Press field with operator name.
- Data on a specific operator is displayed.
- Select and change necessary data.

**New operator can be deleted by the Administrator exclusively.**

Procedure:

- Press and hold operator name.
- Wait to see a menu.
- Select <Delete> parameter.

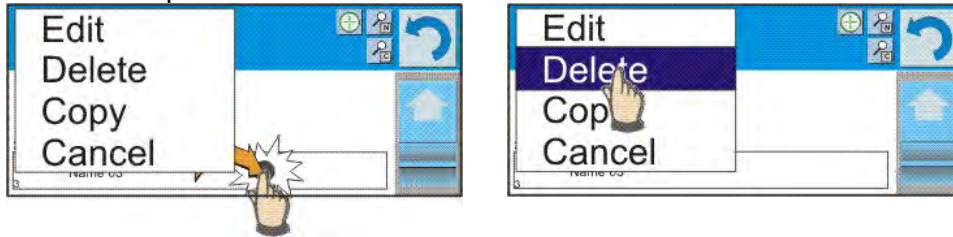

**13. PERMISSIONS**





Permissions specify which operations are enabled/disabled for a particular operator. This menu can be modified by the Administrator exclusively.

**Anonymous operator**

Parameter allowing you to assign unlogged weighing device operator (so called anonymous operator) with permissions.

**Procedure:**

- Enter <  Permissions > menu.
- Select <  Anonymous operator > parameter.
- Set appropriate permissions for the anonymous user.
- Set one of four options: Guest, Operator, Advanced operator, Administrator.



**Caution:**

When < **Guest** > option is set, the software settings cannot be modified by unlogged operator.

**Date and time**

Default mass comparator settings enable operator who is logged as **Administrator** to modify date and time parameter but the software allows to change permissions, and as a result authorize other operators to access <  Date and time > parameter.

**Procedure:**

- Enter  < Permissions > menu.
- Select <<  Date and time > parameter.
- Set one of four options: Guest, Operator, Advanced operator, Administrator.



**Caution:**

When < **Guest** > option is set, all unlogged operators can edit printouts.

## Printouts

Default mass comparator settings enable operator who is logged as **Administrator** to edit printouts but the software allows to change permissions, and as a result authorize other operators to access < Printouts> parameter.

### Procedure:

- Enter < Permissions> menu.
- Select < Printouts> parameter.
- Set one of four options: Guest, Operator, Advanced operator, Administrator.



### Caution:

*When <Guest> option is set, all unlogged operators can edit printouts.*

## Printout/Enter key

Default mass comparator settings enable operator who is logged as **Operator** to edit printouts but the software allows to change permissions, and as a result authorize other operators to access < 1,247 Value release> parameter.

### Procedure:

- Enter < Permissions> menu.
- Select < 1,247 Value release> parameter.
- Set one of four options: Guest, Operator, Advanced operator, Administrator.



### Caution:

*When <Guest> option is set, all unlogged operators can edit printouts.*

## Videos

Default mass comparator settings allow <Videos> menu to be accessed by the **Administrator** exclusively, as a result it is only the Administrator who can perform adding or deleting operations. Providing that respective modifications have been introduced by the Administrator, it is possible for remaining operators to access < Videos> menu options too.

### Procedure:

- Enter < Permissions> menu.
- Select < Videos> parameter.
- Set one of four options: Guest, Operator, Advanced operator, Administrator.

### Caution:

*When <Guest> option is set, all unlogged operators can edit videos settings.*

## Auto logout

Auto logout parameter has been designed to trigger logout operation when the mass comparator stays inactive for specified time interval given in minutes.  
Default parameter setting: <None>.

### Procedure:

- Enter < Permissions> menu.
- Select < Auto logout> parameter.
- Set one of the following options: none/3/5/15/30/60. Time given in [min].

## Minimum Password Characters Quantity

This option enables specifying minimum quantity of characters the password should contain.



**Procedure:**

- Enter < Permissions> menu.
- Select <Minimum password characters quantity> and enter respective value.

**Lower Case and Upper Case Letters Required**

This option imposes using lower case and upper case letters if they were used when creating a password.

**Procedure:**

- Enter < Permissions> menu.
- Select <Lower case and upper case letters required> option.
- Set one of two options: YES - lower case and upper case letters required or NO- lower case and upper case letters not required.

**Digits Required**

This option enables using digits when creating a password.

**Procedure:**

- Enter < Permissions> menu.
- Select <Digits required> option.
- Set one of two options: YES - digits required or NO - digits not required.

**Special Characters Required**

This option enables using special characters when creating a password.

**Procedure:**

- Enter < Permissions> menu.
- Select <Special characters required> option.
- Set one of two options: YES - special characters required or NO - special characters not required.

**Password Validity Period**

This option enables to define password validity period



**Procedure:**

- Enter < Permissions> menu.
- Select <Password validity period> option and enter quantity of days of the password validity.

**Databases**

The Administrator is authorized to set appropriate permissions required in order to enable modification of databases.

**Procedure:**

- Enter < Permissions> menu.
- Select < Databases> parameter.
- Set one of four option for each of the database: Guest, Operator, Advanced operator, Administrator.

**Caution:**

When **<Guest>** option is set, all unlogged operators can edit databases.

## 14. PROFILES

A Profile is a data pack that determines:

- function operation,
- data to be displayed during operation,
- function keys to be active,
- measuring units to be accessible
- criteria determining speed of operation and measurement stability,

Mass comparator software allows you to create numerous profiles, this enables:

- designing an individual working environment by each operator,
- customized mass comparator operation, i.e. activating selected function keys and information (improved operation performance).

### 14.1. Creating a Profile

Default profile: <Home>. The Administrator can create new profiles by:

- Copying an already existing profile and modifying it,
- Creating a new profile.



#### Copying an existing profile

**Procedure:**

- Enter main menu, to do it press **Setup** key.
- Enter <Profiles> submenu.
- Press and hold profile that is to be copied.
- Menu referring to a profile record is displayed. Select <Copy> parameter.
- A new <Copy name> profile is created, new profile settings and base profile settings are identical.
- Modify necessary data: (name, etc.).

#### Adding a new profile

**Procedure:**

- Enter main menu, to do it press **Setup** key.
- Enter <Profiles> submenu.
- Press  button, message box: <Create new record?> is displayed.
- Press  button to confirm. The software automatically adds a new record and enters its editing mode.

#### Deleting a profile

**Procedure:**

- Enter main menu, to do it press **Setup** key.
- Enter <Profiles> submenu.
- Press and hold profile that is to be deleted.
- Menu referring to a profile record is displayed. Select <Delete> parameter.
- Message box: <Delete?> is displayed.
- Press  button to confirm, the profile gets deleted.

#### **Caution:**

*In order to operate profiles it is necessary to log in as an Administrator.*

### 14.2. Profile Structure

Each profile contains the following entries:

- Settings** Enter this menu to set an individual profile name (an order of alphanumeric characters), and to declare a default working mode (the selected mode is activated as default upon selecting the profile).
- Working modes** Contains the following submenus:
- Additional settings of a working mode
  - Buttons
  - Information
  - Printouts
- Readout** Contains the following submenus:
- Filter
  - Value release
  - Autozero
  - Last digit
  - Ambient conditions
- Measuring units** Enter this menu to declare the start unit, the supplementary unit, 2 custom units and to enter the value of gravitational acceleration force in mass comparator's operation place.

#### 14.2.1. Settings

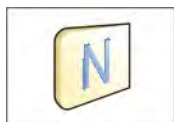

##### Name

Upon entering this option, a message box with keyboard is displayed. Enter the name of a profile and press  button to confirm. The name is assigned to the profile.













##### Default working mode

Upon entering this option you can select a specific working mode, which is set as default in a profile. For <None> parameter set, upon selecting the profile, the mass comparator activates the most recently used working mode.

#### 14.2.2. Working Modes

Upon entering Working Modes option, a window containing all accessible working modes is displayed. Mass comparator features one working mode - < Comparator>.

List of parameters to be modified:

- < Settings>:  
contains specific parameters relating to a working mode and universal settings, such as:  
< Calibration method> , < Cycles quantity>, < Start-up weighing cycles quantity>, < Start delay>, < Tare mode>, < Printout mode>, < Printout>
- < Buttons>:  
declaring quick access keys to be visible on the bottom of the display.
- < Information>:  
declaring information to be displayed in the grey workspace.
- < Printouts>:  
declaring type of a printout or defining a non-standard printout.

### 14.2.3. Readout

The function enables you to adjust mass comparator operation to ambient conditions (filter settings) or your individual needs. < Readout> menu contains the following elements:

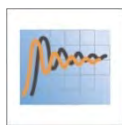

#### **FILTER**

Each measurement signal before being displayed is electronically processed in order to provide correct parameters specific for stable measurement result, i.e. ready to read.

You can determine signal processing extend, there are five different filters for you to select from. Range:

- very fast, fast, average, slow, very slow.

While setting the filter consider the actual operating conditions. In case of very good operating conditions select average or fast filter, : in case of rough conditions select slow or very slow filter.



#### **Value release**

The parameter has been designed to determine when the stability marker is to be displayed.

There are three different settings for value release parameter:

- fast, fast and reliable, reliable.



#### **Caution:**

*Both parameters, filter and value release, determine how long it takes to obtain stable result.*



#### **Autozero**

The function has been designed to enable automatic monitoring and correction of zero indication.

If the function is enabled, the subsequent measurement results are compared to each other in constant time intervals. If the results differ less than declared AUTOZERO range, e.g. 1 division, the mass comparator is automatically zeroed, and the markers of stable indication –  and precise zero –  are displayed. Active AUTOZERO means, that each measurement starts from the precise zero point. There are, however, some cases when this function can be a disturbing factor for the measuring process. For instance during very slow load placing or pouring onto the mass comparator's weighing pan. In such case, the correcting system of zero indication may also correct the actual indication of a load placed on the weighing pan.

Accessible settings:    **NO** - autozero function disabled  
                                  **YES** - autozero function enabled



#### **Last digit**

The function has been designed to enable/disable visibility of the last decimal place of measurement result. Accessible settings:

- **Always:** all digits are displayed.
- **Never:** last digit disabled.
- **When stable:** last digit displayed only when the result is stable.



### Ambient conditions

Parameter relating to ambient and environmental conditions of the workstation.

For unstable ambient conditions it is advisable to set the parameter to value:

**Unstable**. Default value: Stable.

**Stable** setting results with faster operation, i.e. weighing takes much less time than in case of setting to value: Unstable.

### 14.2.4. Measuring Units

For a selected profile you can declare start unit, supplementary unit and two custom measuring units.

A custom measuring unit features:











- a multiplier
- a name (3 characters)

Upon completed operation of designing a custom unit its name is added to the list of accessible measuring units.

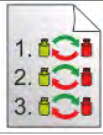
Additionally, units menu enables entering the value of gravitational acceleration force for mass comparator's place of use. It is obligatory should a mass comparator be used to determine mass in [N].

## 15. DATABASES

Mass comparator software features the following databases <  >:

 PRODUCTS	 WEIGHINGS	 CUSTOMERS
 REFERENCE WEIGHTS	 TEST WEIGHTS	 COMPARISON PROCEDURE
 COMPARISON REPORTS	 AMBIENT CONDITIONS	
 WAREHOUSES	 PRINTOUTS	 UNIVERSAL VARIABLES
 MANAGE THE DATABASE		

## 15.1. Processes Carried Out on Databases

Databases can be operated only by an authorized personnel.

Procedure:

- Press and hold for a moment a button with a respective database pictogram.
- Wait to see a menu.
- Select one of available options (options depend on a database type).



Options overview:





- OPEN – option allows you to enter a database (result is similar to the one obtained by a single click).
- IMPORT – option allows you to import data from a USB flash drive. Plug the USB flash drive to a USB port, upon its detection a window with a list of saved files is displayed. Select file with data to be imported. The copying starts automatically. Upon completion of the process a message: <Completed> is displayed. Confirm completion.
- EXPORT - option allows you to export data from a selected database to a USB flash drive. Plug the USB flash drive to a USB port, upon its detection the software automatically starts a copying process. Upon completion of the copying process a window with both, a file name to which data has been saved and message: <Completed> is displayed. Confirm completion.
- INFORMATION – option allows you to display information about database content (see the picture below).



Press  button to return to the previous window.

- CANCEL – the software returns to the home screen.

The following processes can be carried out in almost any of databases:

1. Adding entry to a database <>.
2. Searching for a record in a database by name <>.
3. Searching for a record in a database by code <>.
4. Searching for a record in a database by date <>.

5. Exporting database content to a USB flash drive via USB port <>.



6. Printing data on a specific record in a database <>.

The above processes are carried out by pressing dedicated soft keys located on the top of the display. Follow the displayed commands.

## 15.2. Products

<Products> database contains names of all products that are weighed, counted or controlled.

### Procedure:

- Enter < Databases> submenu, and press < Products> field.
- Press < Add> button to add a new product to the database.
- Select one of available options.

### List of parameters defined for a product:

- |                             |   |
|-----------------------------|---|
| 1. Name                     | [product name]  |
| 2. Description              | [product description]   |
| 3. Code                     | [product code]  |
| 4. EAN code                 | [product EAN code]  |
| 5. Mass                     | [ Unit mass of a product]   |
| 6. Min                      | [ Minimal mass for weighing the product using result control thresholds – LO. Value of error <T1-> in working mode <Mass control> determined as percent of the nominal mass]                    |
| 7. Max                      | [ Maximal mass for weighing the product using result control thresholds – HI. Value of <T1+> error in working mode <Mass control> working mode determined as percent of the nominal mass]       |
| 8. Tolerance                | [% value calculated in relation to mass (5) denoting measuring area in which the measurement is recognized as correct.]   |
| 9. Tare                     | [Product's tare value, set automatically on selecting a product from the database]  |
| 10. Price                   | [Unit price of a product]   |
| 11. Density                 | [Product's density, used for compensating air buoyancy, as sample density] - [g/cm <sup>3</sup> ]   |
| 12. Shelf-life time in days |   |
| 13. Date                    | [Set product's date (constant)]   |
| 14. VAT                     | [VAT value related to a product]  |
| 15. Ingredients             | [Editing field for inserting names of ingredients used for preparing a product, e.g. if a product is a mixture, or if a product requires additional description of its features or application] |
| 16. Printout                | [Printing a template assigned to a product]   |

### Caution:

*Remember to assign products to corresponding functions, as some of data values are attributed according to their modes.*



## 15.3. Weighings



Each measurement result sent from a mass comparator to a printer or a computer is saved to the database of weighing data.

You can preview each weighing record data.

**Procedure:**

- Enter  **Databases**> submenu.
- Enter  **Weighing data**> database and press respective record.



**List of parameters for a weighing record saved to the database:**

1. Measurement date.
2. Measurement result.
3. Tare value.
4. Determination of measurement status (stable / unstable).
5. Air buoyancy compensation.
6. Product name.
7. Operator.
8. Customer, customer name.
9. Working mode name.
10. Warehouse, source warehouse name.
11. Packaging, name of tare applied during product weighing.
12. Result control, information on threshold in which the weighed product was placed:  
MIN – below LOW threshold (possible only if <Result control> is set to <NO>),  
OK – between the LOW and HIGH thresholds,  
MAX – above HIGH threshold (possible only if <Result control> is set to <NO>).
13. Weighing platform no., field denoting number of a weighing instrument using which a measurement was carried out,
14. Levelling, demonstrates if level status was maintained during measurement,
15. Ambient conditions alerts, demonstrates if temperature and humidity were stable during measurement.

#### 15.4. Customers

Customers database contains name of Customers for whom the measurements are carried out.

**Procedure:**

- Enter  **Databases**> submenu and press < Customers> field.
- Press  Add> button.
- If a customer already exists in the database of customers, press field with its name.

**List of parameters defined for a customer:**



1. Customer name
2. Customer code [internal code identifying a customer]
3. NIP
4. Address
5. Postal code
6. City
7. Discount
8. Printout [type of printout, label declared to a customer]

#### 15.5. Reference Weights



<Reference weights> database contains reference weights used for weights comparison. Reference weights are used when determining Comparison procedure.



### Procedure:

- Enter < Databases> submenu and press < Reference weights> field.
- Press < Add> button, should a new reference weight be added.
- If reference weight already exists in the database, press field with its name.

### Caution:

It is possible to use the following functions: < Search by name>, < Search by code>  
< Data export>



### List of parameters defined for a reference mass standard::

1. Name
2. Code
3. Class
4. Serial number
5. Mass
6. Set no.



## 15.6. Test Weights

<Test weights> database contains test weights used for weights comparison. Test weights are used when determining Comparison procedure.

### Procedure:

- Enter < Databases> submenu and press < Test weights> field.
- Press < Add> button, should a new test weight be added.
- If test weight already exists in the database, press field with its name.

### Caution:

It is possible to use the following functions: < Search by name>, < Search by code>  
< Data export>



### List of parameters defined for a reference mass standard::

1. Name
2. Code
3. Class
4. Mass
5. Order number
6. Test weight number



## 15.7. Comparison Procedures

<Comparison procedures> database contains determined comparison processes. Comparison procedures are designed to carry out automatic comparison processes. Remember to determine reference weights and test weights.

### Procedure:



- Enter < Databases> submenu and press < Comparison procedures> field.
- Press < Add> button, should a new comparison procedure be added.
- If comparison procedure already exists in the database, press field with its name.

**Caution:**

It is possible to use the following functions: < Search by name>, < Search by code> < Data export>

**List of parameters defined for Comparison procedures:**

1. Name
2. Code
3. Comparison procedure template (always YES if it is to be remembered)
4. Start delay
5. Start time
6. Clear start time
7. Comparisons

Upon completing information in points 1-6 enter Comparisons file , add new comparison  and assign the following features:



1. Reference weight
2. Test weight
3. Cycles quantity
4. Method
5. Start-up weighing cycles quantity
6. Repeat quantity

Next, you can analogously assign next comparison to the same comparison procedure. The quantity of comparison processes in one comparison procedure is determined by the quantity of test and reference weights with which the mass comparator operates.

**15.8. Comparison Reports**

<Comparison reports> database contains information on carried out comparison processes. Each report can be previewed, searched by date or exported and printed out.

**Procedure:**

- Enter < Databases> submenu and press < Comparison reports> field.
- Press field of a desired report record.



**List of parameters on a comparison report:**

1. Order number
2. Start date
3. End date
4. Operator
5. Diameter
6. Standard deviation
7. Cycles quantity
8. Reference weight
9. Test weight number
10. Task
11. Method

**15.9. Ambient Conditions**

<Ambient conditions> database contains parameters related to ambient conditions. Depending on mass comparator's settings, a report may contain data on temperature, humidity and value of atmospheric pressure. If THB ambient conditions module is connected to a mass comparator, its records are also saved.

**Procedure:**

- Enter < Databases> submenu and press < Ambient conditions> field.
- Press key of a respective report record, unless it is visible on the top of the list, wind the list forward using navigating keys.
- Report's name consists of date and time.



**Caution:**

*It is possible to use an option for searching a report by date or to export a report.*

### 15.10. Packaging

<Packaging> database contains list of packages for which a name, code and mass value are specified. The tare value is automatically applied when a name of a packaging is selected from the database during weighing process. The tare value is displayed with minus sign.

**Procedure:**

- Enter < Databases> submenu and press < Packaging> field.
- Press < Add> button, should a new packaging be designed.
- If a packaging record already exists in the database, press field with its name, and insert data on the packaging.



**Caution:**

*It is possible to use an option for searching a record by name or code.*

### 15.11. Warehouses

Depending on the organization of work, the warehouses database contains list of places used for picking up a sample for weighing or list of places to which a weighed sample was delivered. Each warehouse has to have its name, code and description specified. During weighing process, and on selecting name of a warehouse, it is automatically assigned to the measurement result.

**Procedure:**

- Enter < Databases> submenu and press < Warehouses> field.
- Press < Add> button, should a new warehouse be added.
- If a warehouse record already exists in the database, press field with its name, and insert identifying data.



**Caution:**

*It is possible to use an option for searching a record by name or code.*

### 15.12. Printouts

Printouts database contains all NON-STANDARD printouts. Each printout features a name, code and a template.

**Procedure:**



- Enter < Databases> submenu and press < Printouts> field.
- Press < Add> button, should a new printout be added.
- If a non-standard printout template already exists in the database, press field with its name, and insert identifying data.

**Caution:**

It is possible to use an option for searching a record by name or code.

**Designing new printout template.**

**Procedure:**

- Enter <  Databases> submenu and press <  Printouts> field.
- Press <  Add> button to create or edit a printout.

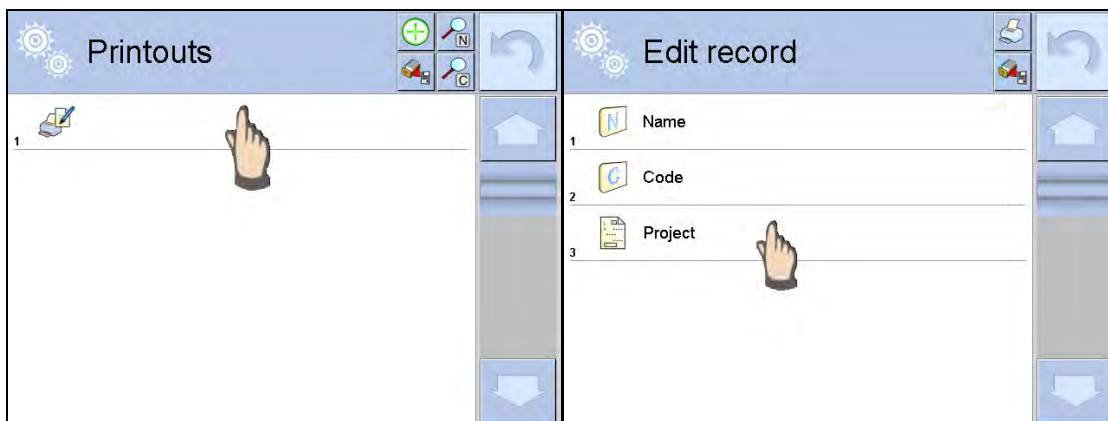

- In <Edit record> parameters press <Project> button.
- A window is opened for creating an optional printout.
- Use on-screen keypad to create printout template. It features the same options as a regular computer keyboard.

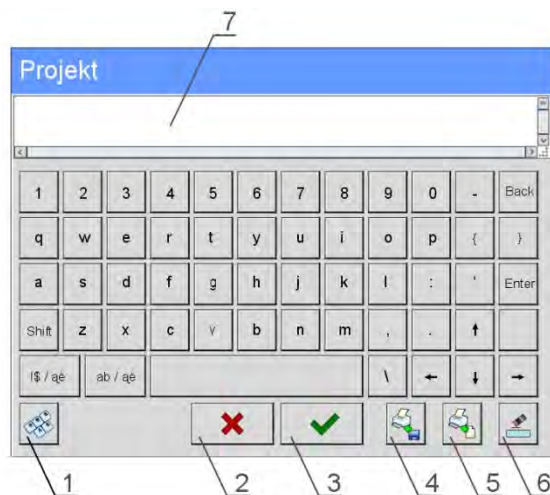

- 1 – enlarging the editing field (7), recommended while using an external computer keyboard connected to mass comparator’s USB port,
- 2 – cancel key
- 3 – confirmation key
- 4 – download a printout template from a file
- 5 – list of variables for use while designing a printout
- 6 – delete all printout content
- 7 – printout editing field

- Save designed printout.

**Caution:**

To delete characters press Back key. To move cursor, press navigation keys.

### Example of Printout no. 1 – using large editing field



*Project*

Mass comparator no. 400015  
Mass comparator parameters:  
Max = 220 g  
d= 0.001 g

Product name:  
Date: 2011.10.24  
Time: 11:48:06  
-----

Working mode: Weighing  
-----

Net weight: 94.147

Carried out by: Admin

*Printout template*

### Example of Printout no. 2 – printout from a file

All printout templates can be designed in a form of external files, that are imported to a mass comparator. Such file has to have the following extension: \*.txt or \*.lb and contain all constant and variable data. Upon importing, the content of a printout template can be modified.



#### Procedure:

- Design a \*.txt or \*.lb file in an optional editor.
- Copy the file to a USB flash drive.
- Connect the USB flash drive to mass comparator's USB port.
- Press [4] <  Download a printout from a file> button,
- Mass comparator's display shows data stored on the USB flash drive connected to the USB port.
- Search for a file with printout template and press its name.
- The printout template is automatically copied to an editing field.

### 15.13. Universal Variables

Universal Variables are a set of alphanumeric data which is combined with printouts, products or other information related to comparison. Each variable has to have its name, code and value specified.

#### Procedure:

- Enter <  Databases> submenu and press <  **Var** Universal variables>.
- Press <  Add> button, should a new variable be added.
- If a universal variable already exists in the database, press field with its name, and insert required modifications to the following fields: code, name, value.

#### Caution:

*It is possible to use an option for searching a record by name or code.*

## 15.14. Databases Management

Function allows you to manage databases data. It comprises three options: Export weighing database, Delete databases and Delete weighings and reports.



### 15.14.1. Export Weighing Database to a File

All carried out measurements are saved to a <Weighing data> database and can be exported to a file using a USB flash drive.

#### Procedure:

- Insert a USB flash drive to mass comparator's USB port.
- Press  Export database of weighing records to a file>, a window for setting export options is opened.



<Data selection> parameter allows you to specify which data related to measurement is to be exported.

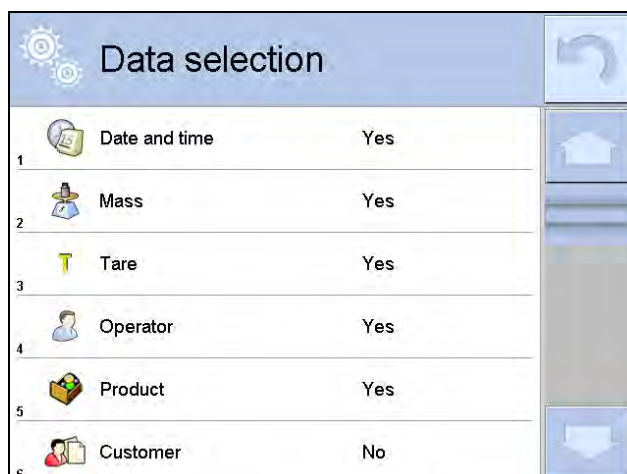

- Set option and press <Export weighing database to a file>, weighing database is automatically exported.
- Upon export completion, message <Completed> is displayed with a respective message, information on number of exported data and the file name (with \*.txt extension). The software returns to the previous window.
- You may return to a weighing procedure or proceed to other settings.

**Caution:**

If a mass comparator software cannot identify the USB flash drive then upon entering <Export weighings database> option, <Operation failed> message is displayed.

- A name of created file consists of database name and mass comparator serial number, e.g. <Weighing data\_364080.txt>.
- Unplug the USB flash drive from the USB port.

**Template of created file:**

The file is created in a form of chart, columns of which are separated with <Tab>. This allows for direct export of the file to <Excel> spread sheet document. The chart contains the following data: date and time, mass and mass unit, tare and tare unit, serial number, operator name, customer name, packaging name, source warehouse name, target warehouse name, control result name.

**15.14.2. Delete Databases**

Function allows you to delete data of selected database. Upon function activation, window for selecting a database data of which is to be deleted is displayed.



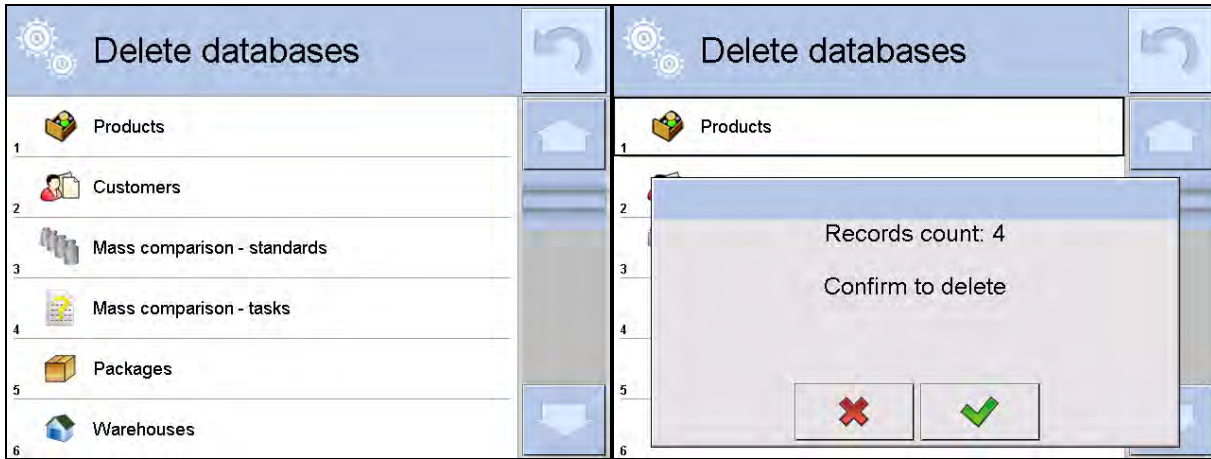

Upon confirmation, data is deleted and the following message is displayed:



Upon confirmation the software returns to a previous window; you may continue a weighing procedure or proceed to other operations.

### 15.14.3. Delete Weighings and Reports

Function allows you to delete weighings and reports of a given database. Activate <Delete weighings and reports> parameter, a window with a numeric keyboard is displayed. Using the keyboard, enter a date specifying which data is to be removed. Date is given in the following form: year-month-day.

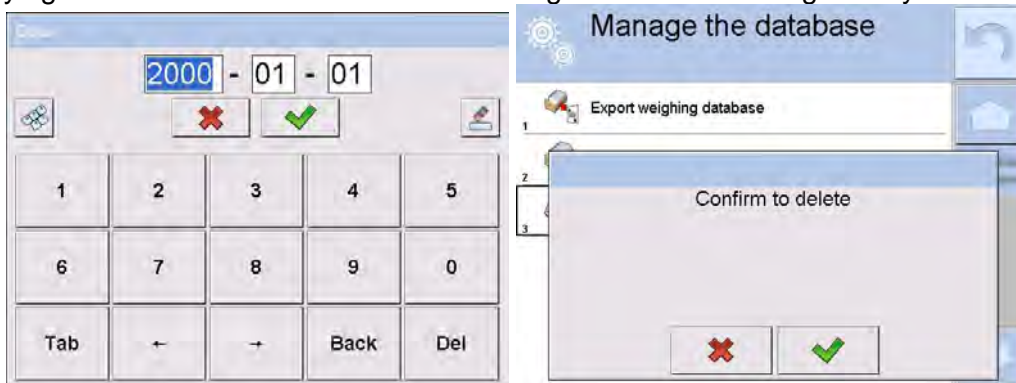

Upon confirmation of entered date, all weighings and reports older than those specified by the date are removed. Quantity of deleted weighments and reports is displayed.



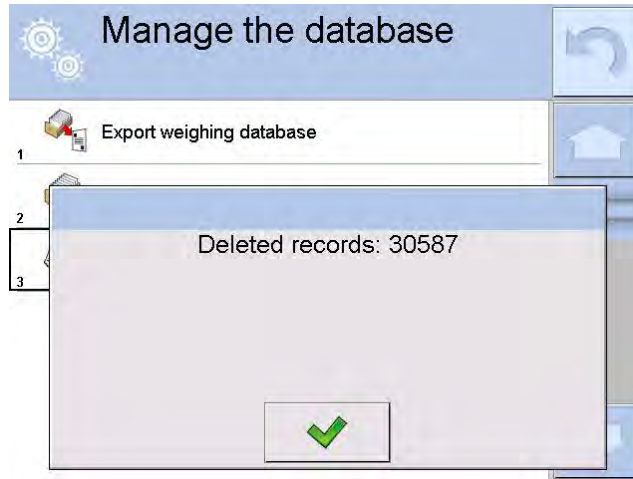





## 16. COMMUNICATION

Communication menu is located in <Parameters> menu. It is accessed by pressing Setup button or <Setup  > quick access key. The mass comparator enables communicating with peripheral devices via the following ports:

-  COM 1 (RS232),
-  COM 2 (RS232),
-  Ethernet,
-  Wi-Fi,
-  TCP.

The ports are to be configured in <  Communication > parameter. Enter <  Communication > parameter and press  button and next press: <  Communication > button.

### 16.1. RS 232 Settings

**Procedure:**

- Select communication port <  COM1 > or <  COM2 >.
- Configure ports.

There are following transmission parameters for RS 232 ports:

- Baud rate: 2400, 4800, 9600, 19200, 38400, 57600, 115200 bit/s
- Data bits: 5, 6, 7, 8
- Stop bits: None, 1, 1.5, 2
- Parity: None, Odd, Even, Marker, Interval

### 16.2. ETHERNET Settings

**Procedure:**

- Select communication port <  Ethernet >. Set appropriate values:
  - DHCP: Yes – No
  - IP Address: 192.168.0.2
  - Subnet mask: 255.255.255.0
  - Default gate: 192.168.0.1

**Caution:**

*Above settings are for information purpose only. Transmission parameters have to be selected in accordance with the settings of customer's local network.*

Upon completing modifications, press  button, the following message is displayed:

<Restart balance to implement changes>.  
Return to weighing mode and restart the device.

### 16.3. Wi-Fi Settings

Mass comparator equipped with Wi-Fi module displays:



#### Procedure:

- Select <  Wifi> communication interface. Set the following parameters:
  - DHCP: Yes – No
  - IP Address: 10.10.9.155
  - Subnet mask: 255.255.255.0
  - Default gate: 10.10.8.244

#### Caution:

Above settings are for information purpose only. Transmission parameters have to be selected in accordance with the settings of customer's local network.

Upon completing modifications, press  button, the following message is displayed:  
<Restart balance to implement changes>.  
Return to weighing mode and restart the device.

You may use <Available networks> parameter to view the list of networks detected by the balance:

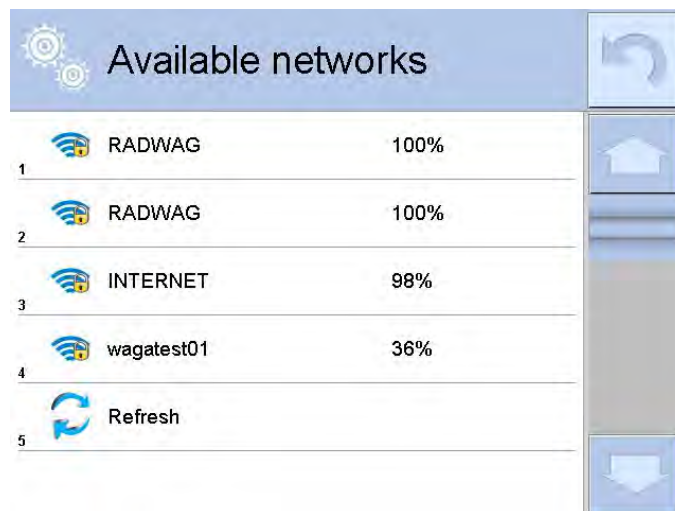

Pictogram with a padlock means that the password is required. Press <Refresh> pictogram to search for available networks.

Press <Network status> field to check selected network parameters. The following message is displayed:

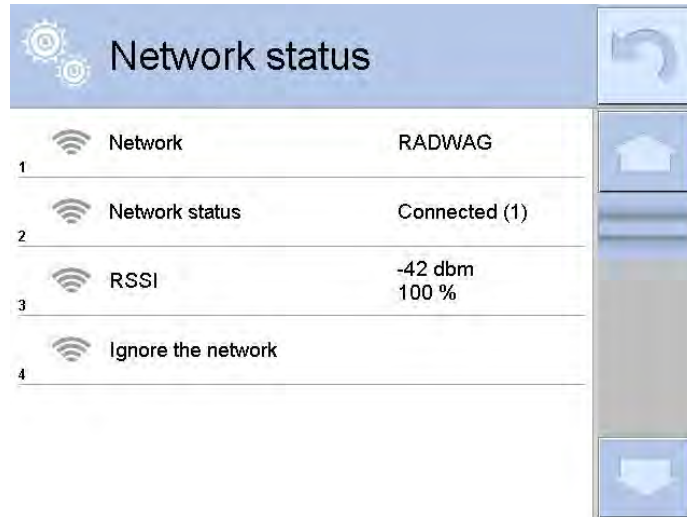

Selected network and parameters for connection are stored in the mass comparator's memory. The software connects to the network using the stored parameters each time the mass comparator is activated. You may change this by selecting <Ignore the network> which disconnects given network.

## 16.4. TCP Settings

TCP ( *Transmission Control Protocol*) operating in customer-server mode enables communicating two computers. You can establish connection on port specified by server.

### Procedure:

- Enter < Communication > parameters.
- Select < Tcp / Port >; a <Port> window with on-screen keyboard is opened.
- Insert required port number and press button to confirm.

## 17. PERIPHERALS

<Peripherals> menu is located in <Parameters> menu. It is accessed by pressing key or pictogram. The menu comprises list of peripheral devices for cooperation with the mass comparator.

### 17.1. Computer

pictogram displayed on the top of the home screen signals active connection between a mass comparator and a computer. < Computer > submenu enables configuration of connection settings.

### Procedure:

- Press key and next press < Peripherals/ Computer >.
- Set the following parameters:
  - Computer port  
available options: none, COM 1, COM 2, Tcp,
  - Address  
give address of mass comparator connected to a computer,
  - Continuous transmission  
available options: NO, YES (*printout format depends on printout template set in a mass comparator– see next parameter*),
  - Interval:  
Parameter enables setting printout frequency for continuous transmission.  
Printout frequency is set in seconds, with 0.1s accuracy.  
You can set frequency in a range from 0.1 to 1000 seconds for continuous transmission activated using mass comparator and computer.
  - Printout template for weighing

Parameter enables printout customization that is to be carried out in a window with printout template.

– E2R System

E2R System performs supervision and control over all weighing processes carried out using mass comparator. Upon enabling the option, the processes carried out on some of the databases are carried out only from the computer level (mode not available in mass comparator's standard version).

**Caution:**

 **E2R System** can only be activated by mass comparator manufacturer or by authorized personnel.

To provide correct cooperation with E2R System continuous transmission has to be activated.

## 17.2. Printer

<Printer> submenu allows you to:

- set port for establishing communication with a printer,
- define printer's code page (default: 1250),
- define control codes for PCL printer or EPSON receipt printer.  
**Caution: Codes must be entered in a hexadecimal form!**
- define printout templates.

Speed of transmission respective for a printer (see: Printer settings) must be selected for the mass comparator to ensure its right cooperation with a printer (diacritical signs specified for a given language). Additionally, printout and printer code pages must be identical.

Code page accordance may be obtained as follows:

- by setting the right code page in the printer (see the printer manual) – respective to printout code page set in a mass comparator; or
- by sending control code from a mass comparator to the printer, which automatically sets the right code page (respective to code page set in a mass comparator ) in advance before execution of the data printout – it is possible only for printers equipped with such option.

*Exemplary mass comparator settings for a correct cooperation (Polish diacritical signs printout) with EPSON printer connected to RS232 port:*

### 1. EPSON TM-U220x Dot matrix printer

Communication parameters:

- baud rate – 9600 bit/s
- data bits – 8
- stop bits – 1
- parity – none

Printer's parameters:

- port – COM 1 or COM 2 (the one to which the printer is connected)
- code page – **852**
- control codes – **1B7412**

### 2. EPSON TM-T20 2. Thermal printer

Communication parameters:

- baud rate – 38400 bit/s
- data bits – 8
- stop bits – 1
- parity – none

Printer's parameters:

- port – COM 1 or COM 2 (the one to which the printer is connected)
- code page – **1250**
- control codes – **1B742D**

Printer's parameters:

- port – COM 1 or COM 2 (the one to which the printer is connected)

- code page – 852
- control codes – 1B7412

If on the printout in the place of the last digit there are any unexpected signs, then <CONTROL CODES> parameter must incorporate, apart from the code page, code of the UK signs chart: **1B5203**. In such case the <CONTROL CODES> parameter setting has to be as follows: control codes – **1B74121B5203**

A printout template describes how to print information from databases.

Printout template can be modified if insufficient. In order to check format of printout template, print data related to e.g. product parameters. – function activated on moving to <Products/Edit product> database and pressing printer pictogram.

### 17.3. Barcode Scanner

Mass comparator allows for cooperation with a barcode scanner. The barcode scanner is used to facilitate quick search for database records:

- Products,
- Operators,
- Customers,
- Packaging,
- Warehouses,
- Series in a differential weighings
- Universal variables,

To configure barcode scanner follow the instruction below:

„ /  **Peripherals** /  **Barcode scanner**”.

#### Caution:

Enter < **Communication**> submenu and set baud rate for a barcode scanner (by default 9600b/s). For detailed description of 'mass comparator' - 'barcode scanner' communication read **APPENDIX E** of this user manual.

#### 17.3.1. Port



##### Procedure:

- Enter < **Peripherals**> parameter and select „ **Barcode scanner** /  **Port**” . Select respective option:

Ports:

- RS 232 (COM1),
- RS 232 (COM2),
- USB





#### 17.3.2. Prefix/Suffix

You can edit < **Prefix**> and < **Suffix**> to synchronize mass comparator's software with barcode scanner.

#### Caution:

In RADWAG weighing instruments prefix contains character (byte) presented as 01 hexadecimal, whereas suffix contains character (byte) 0D hexadecimal. For detailed description on mass comparator-barcode scanner communication refer to **APPENDIX E** of this user manual.



##### Procedure:

- Enter <  **Barcode scanner**> submenu,
- Select <  **Prefix**> parameter and enter hexadecimal value using on-screen keyboard. Press  button to confirm.
- Select <  **Suffix**> parameter and enter hexadecimal value using on-screen keyboard. Press  button to confirm.

### 17.3.3. Field Selection





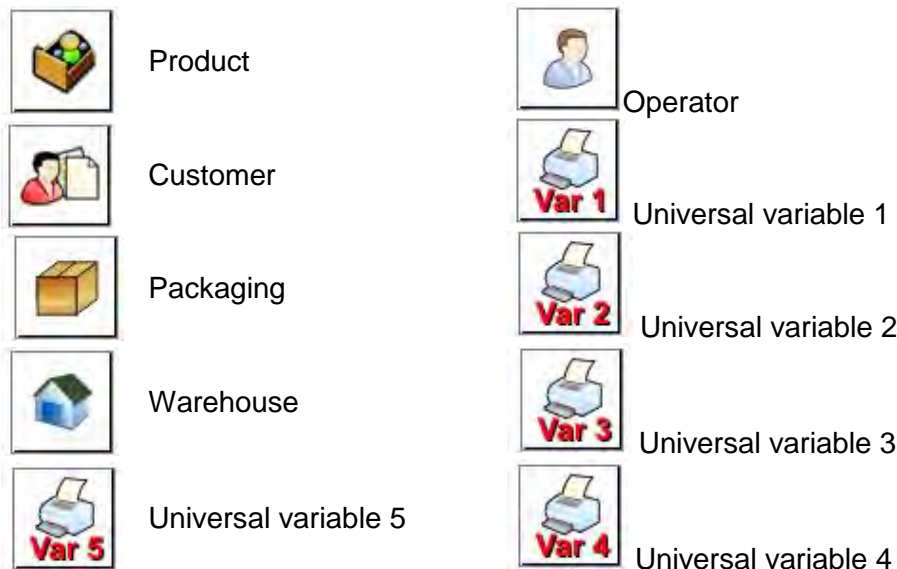

Parameter allowing you to specify, for which field the search is to be carried out in particular databases.

#### Procedure:

- Enter <  **Peripherals**> submenu,
- Select „  **Barcode scanner** /  **Field selection**”. List of fields is displayed:



- Select one item from the list. The following parameters may be edited:

	<b>Filtering</b>	Declaring search criteria (see table below)
	<b>Offset</b>	Declaring the first significant code's character, characters preceding the first significant character are skipped during comparison search. All preceding signs are omitted.
	<b>Code length</b>	Declaring the number of code's characters to be taken into account during search procedure.
	<b>Start marker</b>	Declaring the starting point of scanned code used for searching.
	<b>End marker</b>	Declaring the ending point of scanned code used for searching.
	<b>Ignore marker</b>	Determining whether start and end markers are to be used when comparing scanned code with code saved to the mass comparator.



#### Filtering criteria conditioned by field type:

Field selection	Filtering
Product	None, Name, Code, EAN code
Operator	None, Name, Code,
Customer	None, Name, Code,
Packaging	None, Name, Code,
Warehouse	None, Name, Code,
Series	None, Name, Code,
Universal variables	None, Active

#### 17.3.4. Test

 **Test** parameter allowing you to verify if operation of a barcode scanner connected to a mass comparator is correct.

**Procedure:**

- Enter <  **Barcode scanner** > submenu,
- Select <  **Test** > parameter; <**Test**> edit box is displayed, it features ASCII and HEX fields.
- The code is scanned and entered to the ASCII field and HEX field, next the test result is displayed in the bottom part.

**When:**

- <**Prefix**> and <**Suffix**> declared in mass comparator settings comply with <Prefix> and <Suffix> of the scanned code, the test result is <**Positive**>,
- <**Prefix**> and <**Suffix**> declared in mass comparator settings do NOT comply with <Prefix> and <Suffix> of the scanned code, the test result is <**Negative**>,

#### 17.4. Transponder Card Scanner

You can log in to the mass comparator by means of:

- inserting operator's password using an on-screen keyboard,
- transponder card scanner, by approximating a registered card to the scanner.

**Caution:**

*For correct mass comparator's cooperation with a transponder card scanner set appropriate baud rate value in <  **Communication** > submenu (default 9600b/s).*

#### Transponder card scanner port

The mass comparator enables communicating with a transponder card scanner using the following ports:





- RS 232 (COM1)
- RS 232 (COM2)

In order to log in an operator using a transponder card scanner, first assign a number of an already registered card to a selected operator in the database of operators.

**Procedure:**

- Connect a transponder card scanner to a mass comparator's port (RS 232 COM1 or RS 232 COM2), select communication port in mass comparator settings for the transponder card scanner.



- In <  Communication > submenu set baud rate compatible with the one of the transponder card scanner (default 9600b/s).
- Enter operators database, go to <  Card no. > parameter and edit desired operator's record.
- On entering editing mode in <  Card no. > parameter, a <Card no.> edit box is opened with an on-screen keyboard.
- Approximate the card to the transponder card scanner. The mass comparator automatically displays number of detected card in the <Card no.> field.
- Accept recognized number by pressing  button and return to the weighing.





## 17.5. Additional Display

The mass comparator enables communicating with an additional display via the following ports:

- RS 232 (COM1)
- RS 232 (COM2)
- TCP

Type of data displayed on an additional display is declared in <Project> variable.

### Procedure – designing a variable:

- Enter <  Peripherals > submenu.
- Select <  Additional display/  Project > field, a <Project> edit box with an on-screen keyboard is displayed.
- Use on-screen keyboard to insert desired value of a project, or press <  > button and select respective value from the list.
- Press  button to confirm.

### Caution:

*The mass comparator cooperates with RADWAG WD5/3Y additional display. Ensuring correct cooperation between the mass comparator and the additional display requires that the <  Project > parameter has a variable set to value {140}, and the baud rate value set to 38400 bits/s for a port to which the additional display is connected.*

## 17.6. Ambient Conditions Module

Ambient conditions module (THB) can be connected to the mass comparator via COM 1 or COM 2 port. In order to provide correct cooperation enter connected module address and baud rate for the port (port settings) to which the ambient conditions module is connected (the address and baud rate data is to be found on an ambient conditions data plate).

## 18. INPUTS/OUTPUTS

### Application of inputs:

The set of inputs is used to control mass comparator's operation. The following functions or keys can be assigned to each of 4 inputs:

- |                            |                     |
|----------------------------|---------------------|
| ○ Checkweighing thresholds | ○ Right door        |
| ○ Target value             | ○ Parameters        |
| ○ Profile                  | ○ Statistics        |
| ○ Adjustment               | ○ Add to statistics |
| ○ Zero                     | ○ Product           |
| ○ Tare                     | ○ Warehouse         |









- o Set tare
- o Disable tare
- o Restore tare
- o Packaging
- o Print
- o Header printout
- o Footer printout
- o Universal variable 1 ÷ 5
- o Accept
- o Abort
- o Operator
- o Left door
- o Customer
- o Parts counting: set part mass
- o Parts counting: determine part mass
- o Percent weighing: set reference mass
- o Percent weighing: set 100%
- o Solid density
- o Liquid density
- o Air density
- o Automatic Weight Crane Control
- o Task
- o Reference weight

Upon changing the logic status of the input system, e.g. from [0] to [1], a function that is assigned to the system is carried out. For instance:

- Carrying out automatic adjustment process to check mass comparator's accuracy,
- Displaying the value of set checkweighing thresholds,
- Restoring tare value to carry out net mass weighing.

**Procedure:**

- Press  key and next press:   Inputs/Outputs>.
- Enter<   Inputs/Outputs> submenu and select <   Inputs> parameter.
- Enter editing mode of a selected input; list of available functions is displayed.
- Select function from the list and return to weighing.





**Application of outputs:**

Outputs are used to SIGNAL the status of measurement result. Change of logic status of the output system, e.g. from [0] to [1], takes place on meeting a requirement assigned to the output.



The following data can be assigned to each of 4 outputs:

Option	Mass comparator status switching output logic.
None	-----
Stable	Each stable measurement switches the logic of the system.
MIN stable	Stable measurement below [MIN] threshold switches the logic of the system.
MIN unstable	Unstable measurement below [MIN] threshold switches the logic of the system.
OK stable	Stable measurement within [MIN] [MAX] thresholds switches the logic of the system.
OK unstable	Unstable measurement within [MIN] [MAX] thresholds switches the logic of the system.
MAX stable	Stable measurement below [MAX] threshold switches the logic of the system.
MAX unstable	Unstable measurement below [MAX] threshold switches the logic of the system.
Confirmation of cycle completion	End of procedure.

**Procedure:**

- Press  key and next press: <  Inputs/Outputs >.
- Enter <  Inputs/Outputs > submenu and select <  Inputs > parameter.
- Enter editing mode of a selected input; list of available functions is displayed.
- Select function from the list and return to weighing with changes saving.

## 19. MISCELLANEOUS

Parameters facilitating mass comparator operation, such as: language, date-time, beep sound, display adjustment, level control. To enter <Misc.> submenu, press  key and next press <  Misc.> button.

### 19.1. Language

#### Procedure:

Enter <  Misc.> submenu.



Select <  Language > parameter and select language.

Available languages: Polish, English, German, French, Spanish, Korean, Turkish, Chinese, Italian, Czech, Romanian, Hungarian, Russian.

### 19.2. Date and Time





You can set date, time and their formats.

There are two ways to enter date and time settings:

- Press <**Date and time**> parameter located on the top of the display (in main menu mode).
- Press <  /  **Misc./**  **Date and time**>.

Enter date and time settings, an on-screen keyboard is displayed. Set date and time in the following order: year, month, day, hour, minute. Press  button to confirm.

Submenu: <  /  **Misc./**  **Date and time**> contains additional functions for defining date and time format:

Pictogram	Name	Value	Overview
	Time zone	(UTC+01:00) Sarajevo, Skopje, Warsaw, Zagreb	Parameter value: name of time zone/country, which informs of summer/winter time change. The information comes from Microsoft website.
	Automatically adjust clock for daylight saving	Yes	Function enables or disables automatic clock adjustment. On parameter change restart the mass comparator.
	Date and time	2016.04.04 08:00:00	Mass comparator's date and time setting
	Date format	yyyy.MM.dd *	Selecting date format. Available settings: d.M.yy, d/M/yy, d.M.yyyy, dd.MM.yy, dd/MM/yy, dd-MM-yy, dd.MM.yyyy, dd/MM/yyyy, dd-MMM-yy, dd.MMM.yyyy, M/d/yy, M/d/yyyy, MM/dd/yy, MM/dd/yyyy, yy-M-dd, yy/MM/dd, yy-MM-dd, yyyy-M-dd, yyyy.MM.dd, yyyy-MM-dd.
	Time format	HH:mm:ss **	Selecting time format. Available settings: H.mm.ss, H:mm:ss, H-mm-ss, HH.mm.ss, HH:mm:ss, HH-mm-ss, H.mm.ss tt, H:mm:ss tt, H-mm-ss tt, HH.mm.ss tt, HH:mm:ss tt.

			HH-mm-ss	tt,	h.mm.ss	tt,
			h:mm:ss	tt,	h-mm-ss	tt,
			hh.mm.ss	tt,	hh:mm:ss	tt,
			hh-mm-ss	tt		

\*) - For date format: y – year, M – month, d – day

\*\*\*) - For time format: H – hour, m – minute, s – second

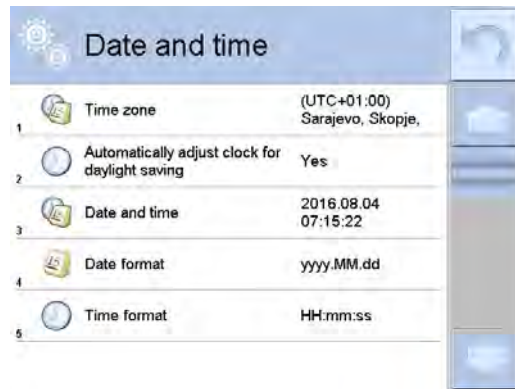

<  Date and time> parameter enables previewing declared date and time formats.



**Caution:**



<  Date and time> parameter can be accessed only by an operator with appropriate permissions. Permissions level can be modified by administrator in <Permissions> menu.

**19.3. Touch Panel Sound**

Enter <  Misc.> submenu, select <  Touch panel sound> parameter and set appropriate option:  
 No – Touch panel sound disabled  
 Yes – Touch panel sound enabled

**19.4. „Beep” Sound**



**Procedure:**

Enter <  Misc.> submenu, select <  Beep> parameter and set appropriate option:  
 None - Beep sound disabled for keys/buttons and proximity sensors  
 Keys/Buttons - Beep sound enabled for keys/buttons  
 Sensors - Beep sound enabled for proximity sensors  
 All - Beep sound enabled for keys/buttons and proximity sensors

**19.5. Volume**

You can change volume of the weighing terminal loudspeaker.



Procedure:

- Press  key and next press: <  Misc./Volume>.  
 An on-screen keyboard is displayed. Enter volume in percent: 100% - maximum volume, 0% - minimum volume (loudspeaker off).

**19.6. Display Sleep Mode**

You can turn on display sleep mode.

Procedure:

- Press  key and next press: <  Misc./Display sleep mode>.

Select one of the following options: [None; 1; 2; 3; 5; 10; 15]. Digit values stand for a number of minutes. Upon selecting desired value, the software returns to the previous menu.



**Caution:**

Display turns to sleep mode only when the mass comparator is not operated (the indication on the screen remains the same). Upon mass change, or pressing any key on the panel, the mass comparator returns to weighing.

### 19.7. Display Brightness

Display brightness influences mass comparator operation time, when the mass comparator is powered with battery. To lengthen the operation, brightness of the display has to be reduced.

Procedure:



- Press  key and next press:  Misc./Display brightness>.

Enter desired value: [0% - 100%]. Display automatically changes brightness and the software returns to the previous menu.

### 19.8. Touch Panel Calibration

Display calibration is required if the touch panel does not react correctly during operation.

Procedure:

- Enter  Misc.> submenu.
- Select  Touch panel calibration> parameter, an edit box is displayed.
- Use finger or a thin (but not sharp edged) and soft stylus to press and hold a display area with a cross. After pressing the fifth cross in order, accept the changes by pressing  key.



**Caution:**

The process can be aborted by pressing Esc key on an external keyboard connected to the mass comparator's terminal.

### 19.9. Level Control

The mass comparator is equipped with Automatic Level Control mechanism.

Procedure:

- Enter  <Misc.> submenu.
- Select  Level control> parameter, an edit box is displayed.
- Select one of available options:
  - None – level indicator is not displayed, the mass comparator does not control level status,
  - Active – level indicator is displayed, the mass comparator alerts level change by changing colour of level indicator (green→ level status OK, red→ level status lost),
  - Active with lock – level indicator is displayed, the mass comparator alerts level change by changing colour of level indicator (green→ level status OK, red → level status lost). If level indicator is red, the display also shows an alert – no Level - , and blocks weighing function until level status is restored.



**Caution:**

For detailed information on mass comparator levelling refer to section 10.3 of this user manual.

### 19.10. Proximity Sensors Sensitivity

The parameter is adjustable between 0 – 9, and it determines the distance from which the IR proximity sensors react.

As standard, the sensitivity is set within the range of 5 to 7.



**Procedure:**

- Enter <[Hand icon]> <Misc.> submenu.
- Select <Proximity sensors sensitivity> parameter, an edit box is displayed.
- Select one of available options. The selection causes immediate returning to the menu window.
- 

### 19.11. Proximity Sensors Timeout

Parameter enables setting timeout of proximity sensors that is expressed in [ms].

Default value: <0>.

When using option of motion recognition set <Proximity sensors timeout> parameter to <500ms> value.

**Procedure:**

- Enter <[Hand icon]> <Misc.> submenu.
- Select <Proximity sensors timeout> parameter, an on-screen keyboard is displayed.
- Enter <500> value.
- Confirm. The software returns to menu window.

### 19.12. Autotest



<AUTOTEST> function is designed to aid you in both assessing mass comparator's operation and diagnosing the reasons for occurrence of errors in weighing which exceed the maximum permissible values for a given mass comparator model.

By means of a simple, repeatable and fully documented way the function enables optimizing mass comparator's settings to maintain the best possible repeatability and weighing time at a workstation. The main purpose of function operation is the possibility of monitoring the above mentioned parameters at optional moment and saving records from carried out tests.

The functions is divided into two modules:

AUTOTEST FILTER; AUTOTEST GLP.

Before testing the mass comparator controls its level status, temperature and humidity.



#### AUTOTEST FILTER

It is a process of 10 times loading and unloading of the internal weight for all possible settings of mass comparator's filter and value release. The test controls 2 parameters: Repeatability and stabilization time of measurement result.

The whole testing process takes approximately 1 hour. Upon completing the test for all possible settings, mass comparator displays a message with obtained results.

You are given information on optimum mass comparator settings in present ambient conditions.

The function provides data on the best possible mass comparator settings for obtaining the highest measurement repeatability and the shortest measurement time with acceptable value of repeatability.

Test results are stored in mass comparator memory until the mass comparator is turned off.

Additionally the function enables:

- Printing test results
- Selecting optimum parameters from the mass comparator's option level.

Upon completed autotest, a summary with results is displayed. The software automatically informs on filters settings by means of respective pictograms displayed by the results:



- settings providing the fastest measurement (the shortest time interval for measurement performance).



- settings providing the most accurate measurement (the lowest possible value of deviation for 10 measurements).



- settings providing optimal measurement (the lowest value of time and deviation product).



- current settings for filters.

Measurement results:

\*Filter type.

\*Setting of <Value release> parameter.

\*Repeatability of indications expressed as standard deviation.

\*Average time of measurement stabilization.

Example:

Autotest Filter		
3	Very fast Reliable	0.0010 g 3.650 s
4	Fast Fast	0.0005 g 1.536 s
5	Fast Fast and reliable	0.0005 g 2.038 s
6	Fast Reliable	0.0004 g 3.181 s
7	Normal Fast	0.0005 g 2.393 s
8	Normal Fast and reliable	0.0011 g 2.881 s

Autotest Filter		
4	Fast Fast	0.0005 g 1.536 s
5	Fast Fast and reliable	0.0005 g 2.038 s
6	Fast Reliable	0.0004 g 3.181 s
7	Normal Fast	0.0005 g 2.393 s
8	Normal Fast and reliable	0.0011 g 2.881 s
9	Normal Reliable	0.0005 g 4.073 s

You can quickly modify filters settings and settings for results approval. To do that, select a group of results for particular settings that are to be saved. Press <Activate>.

Autotest Filter		
3	Very fast Reliable	0.0010 g 3.650 s
4	Fast Fast	0.0005 g 1.536 s
5	Fast Fast and reliable	0.0005 g 2.038 s
6	Fast Reliable	0.0004 g 3.181 s
7	Normal Fast	0.0005 g 2.393 s
8	Normal Fast and reliable	0.0011 g 2.881 s

Autotest Filter		
1	Filter	Fast
2	Value release	Fast
3	Repeatability	0.0005 g
4	Stabilization time	1.536 s
5	Enable	



## Report template:

----- Autotest Filter: Report -----  
Mass comparator type WAY 100 4Y  
Mass comparator S/N 442566  
Operator Hubert  
Software ver. NL1.6.5 S  
Date 2015.05.07  
Time 09:34:48

-----  
Reading unit 0.0001/0.0001 g  
Internal weight mass 148.9390 g  
Temperature: Start 25.26 °C  
Temperature: Stop 25.66 °C  
-----

Filter Very fast  
Value release Fast  
Repeatability 0.0042 g  
Stabilization time 4.505 s  
.

Filter Very slow  
Value release Reliable  
Repeatability 0.0207 g  
Stabilization time 5.015 s

Signature  
.....

## Procedure:

Upon function activation, the process is started automatically. Progress of the process is displayed. Upon process completion, a summary and marked values of currently set filter values are displayed. The report can be printed.

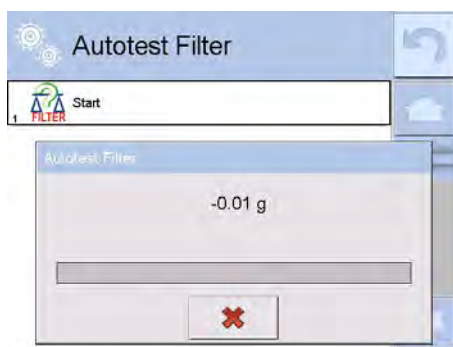

You can abort the process at any moment. To do that press <X> button.



## AUTOTEST GLP

The test controls repeatability of loading the internal weight and determining error of indication with reference to mass comparator's maximum capacity.

### Procedure:

- Two times loading of the internal weight, followed by 10 times loading of the internal weight.
- Mass comparator internal adjustment.
- Calculating and recording the value of standard deviation.
- In mass comparators with automatically opened doors, door opening and closing test is carried out.

Additionally the function enables: displaying and printing a report on available printers and saving the report in mass comparator's memory. The report contains basic data on mass comparator's parameters, ambient conditions and test results.

Test results:

\*Deviation for maximum capacity.

\*Value of repeatability expressed as standard deviation.

\*Result of door test (positive / negative) – if a mass comparator features automatic door opening system.

**Report template:**

----- Autotest GLP: Report -----  
Mass comparator type WAY 100.4Y  
Mass comparator S/N 400010  
Operator Admin  
Software ver. L0.0.21 S  
Date 2012.01.16  
Time 09:17:16

-----  
Measurements quantity 10  
Reading unit 0.0001 g  
Internal weight mass 140.094 g  
Filter Average  
Value release Fast & reliable

-----  
Deviation for Max. -0.0118 g  
Repeatability 0.00088 g  
Signature

**Procedure:**

Upon pressing a field with test name, the mass comparator displays a message box.

Upon this level, you can:

- Start subsequent AUTOTEST GLP process,
- Preview results of completed autotests, and export all saved test results as file with \*.csv extension,
- Delete all saved test results.

You can abort the process at any moment by pressing <X> button.

Results of carried out autotests are displayed as a table (each line features date and time of autotest procedure and its result).

To preview detailed data of an autotest, press a specified line of the table with test results.

In order to print a result of a single autotest, enter its details (see above) and generate a printout by pressing <Print> key located on the top of the display.

Autotest results can be exported by pressing <Export> field in the window with all saved reports. Data is sent to a USB flash drive connected to mass comparator's USB port as a file with \*.csv extension.

**19.13.Start-Up Logo**

*(option enabled only for authorized mass comparator operators)*

The parameter enables changing a logo that appears on the mass comparator's display on a start-up procedure.

**19.14.Export of System Events**

*(option enabled only for authorized mass comparator operators)*

The parameter enables generating a special type of a file that is automatically saved upon enabling an option on a USB flash drive connected to mass comparator's USB port. The file is used by RADWAG service for diagnosing any potential problems that occur during mass comparator operation.

**Procedure:**

- Plug a USB flash drive to mass comparator's USB port.



- Enter  Misc.> submenu.
- Select <Export system events> parameter.
- The software generates a file and automatically saves it on the USB flash drive.
- The generated file has to be sent to RADWAG.

## 20. AMBIENT CONDITIONS

Mass comparators are equipped with ambient conditions sensors, which record ambient conditions of the mass comparator's inside, and optionally with an external THB module which records ambient conditions outside the mass comparator:

- Internal sensor: Temperature 1
- Internal sensor: Temperature 2
- Internal sensor: Humidity
- \*External sensor: THB ambient conditions module

\*External sensor is provided on a customer request.



You can modify the following parameters in <Ambient conditions> submenu:

- Ambient conditions recording interval
- Ambient conditions module

### Procedure

Enter  Parameters> menu.

Select  Ambient conditions> parameter.

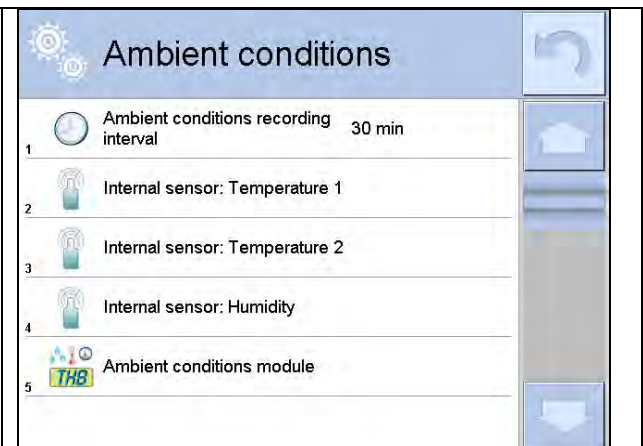
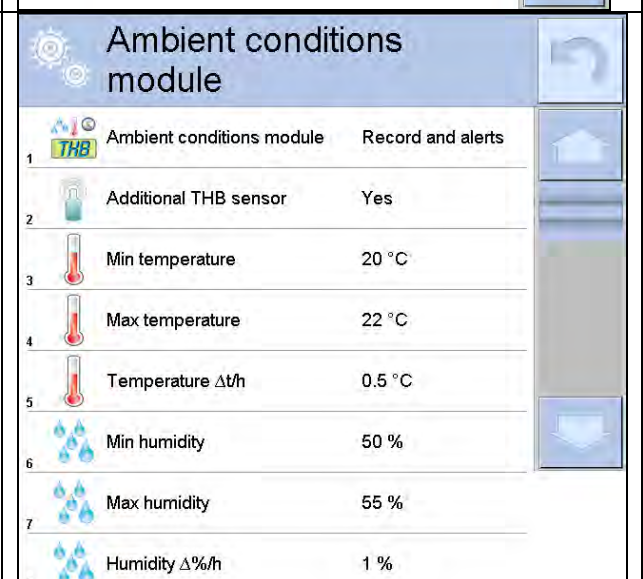
<p>Enter &lt;Ambient conditions recording interval&gt; parameter and specify the intervals for ambient conditions records.</p> <p>You can view the history of ambient conditions records. All ambient conditions records are to be found in  Database&gt; in  Ambient conditions&gt; database.</p>	 <p>The screenshot shows the 'Ambient conditions' menu with the following items:</p> <ul style="list-style-type: none"> <li>1 Ambient conditions recording interval 30 min</li> <li>2 Internal sensor: Temperature 1</li> <li>3 Internal sensor: Temperature 2</li> <li>4 Internal sensor: Humidity</li> <li>5 Ambient conditions module</li> </ul>
<p>Enter &lt;Ambient conditions&gt; menu and determine ambient conditions parameters.</p> <p>Thermo-hygro-barometer (THB) &lt;Ambient conditions module&gt; is a module that records 3 types of ambient conditions:</p> <ul style="list-style-type: none"> <li>• Temperature</li> <li>• Humidity</li> <li>• Pressure</li> </ul>	 <p>The screenshot shows the 'Ambient conditions module' menu with the following items:</p> <ul style="list-style-type: none"> <li>1 Ambient conditions module Record and alerts</li> <li>2 Additional THB sensor Yes</li> <li>3 Min temperature 20 °C</li> <li>4 Max temperature 22 °C</li> <li>5 Temperature Δt/h 0.5 °C</li> <li>6 Min humidity 50 %</li> <li>7 Max humidity 55 %</li> <li>8 Humidity Δ%/h 1 %</li> </ul>

### Caution:

Ambient conditions determined by the operator cannot exceed the limits specified in ambient conditions module Technical Specifications. If ambient conditions are different than those specified in the Technical Specifications, the mass comparator may not operate as intended.

## 21. UPDATE

The function enables updating:

- Help files available from the operator level.
- Area of an operator: APPLICATION.
- Metrological parameters: main board (only administrator).

Updating process takes place automatically by loading data from a USB flash drive connected to mass comparator's USB port.

### Procedure:

- Prepare a USB flash drive with update file. Required file extension: \*.lab2.
- Connect the USB flash drive to mass comparator's USB port.
- Select menu <Application>.
- The display previews content of the USB flash drive, search for the update file and press its name.
- Updating process is automatic.

The process of updating help files and the main board file takes places analogously to the above described procedure, but the required extension of the update file is: \*.hlp - help, \*.mbu – main board.

## 22. ABOUT

This menu contains data on mass comparator specification and installed applications. Most of parameters in this menu are for the information purpose only.



About	
1	Balance ID 20161220
2	Balance type UYA 4Y.KO
3	Balance name RADWAG
4	Software version NL1.8 K
5	Product code 680560610252
6	Weighing firmware version 2.4.5

<Ambient conditions> parameter enables previewing present ambient conditions: temperature, humidity, pressure (if a mass comparator features corresponding ambient conditions sensors).

Upon selecting <Print settings> parameter the mass comparator sends all settings to a printer.

## 23. VIDEOS

This menu enables displaying instruction videos on how to operate mass comparator. Videos are saved with the following extension: \*.wmv. <Videos> parameter group allows the user with <Administrator> permissions to add/delete videos from the mass comparator memory. Other operators may only watch the videos stored in the mass comparator memory.

To add a video you have to:

	<ul style="list-style-type: none"> <li>• Save the video on a USB flash drive.</li> <li>• Plug the flash drive to mass comparator's USB port.</li> <li>• Enter &lt;Videos&gt; menu.</li> <li>• Press  button located on the top.</li> <li>• Select respective file.</li> <li>• The video is saved to the mass comparator memory.</li> </ul>
--	---

To play the video you have to:

- Save the video to the mass comparator memory (see instruction above).
- Enter <Videos> menu.
- Press the name of a video to be played.

--	--

The video starts automatically.

Functions available for playback are as follows:

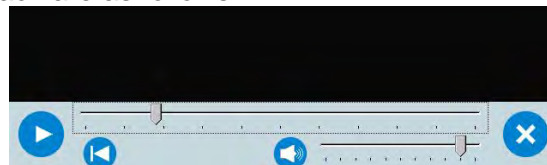

	Play/ Pause playing
	Stop playing
	Increase/decrease the volume (volume power adjusted, for settings go to <Misc.> menu).
	Enabling/Disabling the volume
	Restart video

## 24. COMMUNICATION PROTOCOL

### General Information

A. A character based communication protocol mass comparator- indicator is designed for establishing communication between a RADWAG mass comparator and a peripheral device via RS-232C interface.

- B. The protocol consists of commands sent from a peripheral device to the weighing device and responses from the weighing device.
- C. Responses are sent from the weighing device each time a command is received.
- D. Commands, forming the communication protocol, enable obtaining data on weighing device status and facilitate influencing weighing device operation, e.g.: acquiring measurement results from the weighing device, zeroing, etc.

#### 24.1. List of Commands

Command	Command overview
<b>Z</b>	Zeroing
<b>T</b>	Taring
<b>OT</b>	Give tare value
<b>UT</b>	Set tare
<b>S</b>	Send stable measurement result in basic measuring unit
<b>SI</b>	Immediately send measurement result in basic measuring unit
<b>SIA</b>	Immediately give results from all platforms in basic measuring units
<b>SU</b>	Send stable measurement result in current measuring unit
<b>SUI</b>	Immediately send measurement result in current measuring unit
<b>C1</b>	Switch on continuous transmission in basic measuring unit
<b>C0</b>	Switch off continuous transmission in basic measuring unit
<b>CU1</b>	Switch on continuous transmission in current measuring unit
<b>CU0</b>	Switch off continuous transmission in current measuring unit
<b>DH</b>	Set min checkweighing threshold
<b>UH</b>	Set max checkweighing threshold
<b>ODH</b>	Give value of min checkweighing threshold
<b>OUH</b>	Give value of max checkweighing threshold
<b>SM</b>	Set mass value of a single item
<b>TV</b>	Set target mass value
<b>RM</b>	Set reference mass value
<b>NB</b>	Give mass comparator serial number
<b>PROFILES</b>	Set balance profile
<b>LOGIN</b>	Operator logging
<b>LOGOUT</b>	Operator logout
<b>SS</b>	Value release
<b>IC</b>	Internal adjustment performance
<b>IC1</b>	Disable automatic internal adjustment of the mass comparator
<b>IC0</b>	Enable automatic internal adjustment of the mass comparator
<b>K1</b>	Lock mass comparator keypad
<b>K0</b>	Unlock mass comparator keypad
<b>BP</b>	Activate sound signal

<b>OMI</b>	Give available working modes
<b>OMS</b>	Set working mode
<b>OMG</b>	Give current working mode
<b>PC</b>	Send all implemented commands
<b>BN</b>	Give mass comparator type
<b>FS</b>	Give max capacity
<b>RV</b>	Give program version
<b>A</b>	Set AUTOZERO function
<b>EV</b>	Set ambient conditions state
<b>FIS</b>	Set filter
<b>ARS</b>	Set value release
<b>LDS</b>	Set last digit
<b>UI</b>	Give accessible units
<b>US</b>	Set current unit
<b>UG</b>	Give current unit
<b>NT</b>	Cooperation with PUE 7.1, PUE 10 indicator

**Caution:**

Each command must end with CR LF characters.

## 24.2. Response Format

On receipt of a command, the terminal responds as follows:

XX_A CR LF	command understood and in progress
XX_D CR LF	command carried out (appears only after the XX_A command)
XX_I CR LF	command understood but not accessible at this moment
XX _ ^ CR LF	command understood but max threshold is exceeded
XX _ v CR LF	command understood but min threshold is exceeded
XX _ OK CR LF	command carried out
ES_CR LF	command not recognised
XX _ E CR LF	time limit exceeded while waiting for stable measurement (time limit is a characteristic parameter of mass comparator)

**XX** - stands for a name of a sent command

\_ - space

## COMMANDS OVERVIEW

## Zeroing

Format: **Z CR LF**

Response options:

- Z\_A CR LF - command understood and in progress
- Z\_D CR LF - command carried out
- Z\_A CR LF - command understood and in progress
- Z\_^ CR LF - command understood but zeroing range is exceeded
- Z\_A CR LF - command understood and in progress
- Z\_E CR LF - time limit exceeded while waiting for stable measurement result
- Z\_I CR LF - command understood but not accessible at this moment

## Taring

Format: **T CR LF**

Response options:

- T\_A CR LF - command understood and in progress
- T\_D CR LF - command carried out
- T\_A CR LF - command understood and in progress
- T\_v CR LF - command understood but taring range is exceeded
- T\_A CR LF - command understood and in progress
- T\_E CR LF - time limit exceeded while waiting for stable measurement result
- T\_I CR LF - command understood but not accessible at this moment

## Give tare value

Format: **OT CR LF**

Response: **OT\_TARE CR LF** - command carried out

Response format:

1	2	3	4-12	13	14	15	16	17	18	19
O	T	space	tare	space	unit			space	CR	LF

**Tare** - 9 characters, right justification

**Unit** - 3 characters, left justification

### **Caution:**

*Tare value is always given in adjustment unit.*

## Set tare

Format: **UT\_TARE CR LF**, where **TARE** - tare value

Response options:

- UT\_OK CR LF - command carried out
- UT\_I CR LF - command understood but not accessible at this moment
- ES CR LF - command not recognised (tare format incorrect)

### **Caution:**

*Use dot in tare format as decimal point.*

## Send stable measurement result in basic measuring unit

Format: **S CR LF**

Response options:

- S\_A CR LF - command understood and in progress

- S\_E CR LF - time limit exceeded while waiting for stable measurement result
- S\_I CR LF - command understood but not accessible at this moment
- MASS FRAME - command carried out, immediate response: mass value in basic measuring unit

Response format :

1	2-3	4	5	6	7-15	16	17	18	19	20	21
S	space	stability marker	space	character	mass	space	unit			CR	LF

**Example:**

- S CR LF - command sent from a computer
- S \_ A CR LF - command understood and in progress
- S \_ \_ \_ \_ - \_ \_ \_ \_ \_ 8 . 5 \_ g \_ \_ CR LF - command carried out, immediate response: mass value in basic measuring unit

where: \_ - space

**Immediately send measurement result in basic measuring unit**

Format: **SI CR LF**

Response options:

- SI\_I CR LF - command understood but not accessible at this moment
- MASS FRAME - command carried out, immediate response: mass value in basic measuring unit

Response format :

1	2	3	4	5	6	7-15	16	17	18	19	20	21
S	I	space	stability marker	space	character	mass	space	unit			CR	LF

**Example:**

- S I CR LF - command sent from a computer
- S I \_ ? \_ \_ \_ \_ \_ 1 8 . 5 \_ k g \_ CR LF - command carried out, immediate response: mass value in basic measuring unit

where: \_ - space

**Send stable measurement result in current measuring unit**

Format: **SU CR LF**

Response options:

- SU\_A CR LF - command understood and in progress
- SU\_E CR LF - time limit exceeded while waiting for stable measurement result
- SU\_I CR LF - command understood but not accessible at this moment
- MASS FRAME - command carried out, immediate response: mass value in basic measuring unit

Response format :

1	2	3	4	5	6	7-15	16	17	18	19	20	21
S	U	space	stability marker	space	character	mass	space	unit			CR	LF

**Example:**

- S U CR LF - command sent from a computer
- S U \_ A CR LF - command understood and in progress
- S U \_ \_ \_ - \_ \_ 1 7 2 . 1 3 5 \_ N \_ \_ CR LF - command carried out, immediate response: mass value in current measuring unit.

where: \_ - space

**Immediately send measurement result in current measuring unit**

Format: **SUI CR LF**

Response options:

SUI\_I CR LF - command understood but not accessible at this moment

MASS FRAME - command carried out, immediate response: mass value in basic measuring unit

Response format:

1	2	3	4	5	6	7-15	16	17	18	19	20	21
S	U	I	stability marker	space	character	mass	space	unit			CR	LF

Example:

**SUI CR LF** - command sent from a computer

**SUI ? \_ - \_ \_ \_ 5 8 . 2 3 7 \_ k g \_ CR LF** - command carried out, immediate response: mass value in basic measuring unit

where: \_ - space

### Switch on continuous transmission in basic measuring unit

Format: **C1 CR LF**

Response options:

C1\_I CR LF - command understood but not accessible at this moment

C1\_A CR LF - command understood and in progress

MASS FRAME - command carried out, immediate response: mass value in basic measuring unit

Response format:

1	2	3	4	5	6	7-15	16	17	18	19	20	21
S	I	space	stability marker	space	character	mass	space	unit			CR	LF

### Switch off continuous transmission in basic measuring unit

Format: **C0 CR LF**

Response options:

C0\_I CR LF - command understood but not accessible at this moment

C0\_A CR LF - command understood and carried out

### Switch on continuous transmission in current measuring unit

Format: **CU1 CR LF**

Response options:

CU1\_I CR LF - command understood but not accessible at this moment

CU1\_A CR LF - command understood and in progress

MASS FRAME - response: mass value in current measuring unit

Response format :

1	2	3	4	5	6	7-15	16	17	18	19	20	21
S	U	I	stability marker	space	character	mass	space	unit			CR	LF

### Switch off continuous transmission in current measuring unit

Format: **CU0 CR LF**

Response options:

CU0\_I CR LF - command understood but not accessible at this moment

CU0\_A CR LF - command understood and carried out

### Set min checkweighing threshold



Format: **DH\_XXXXX CR LF**, where: \_ - space, **XXXXX** - mass format

Response options:

DH\_OK CR LF - command carried out

ES CR LF - command not recognised (mass format incorrect)

#### **Set max checkweighing threshold**

Format: **UH\_XXXXX CR LF**, where: \_ - space, **XXXXX** - mass format

Response options:

UH\_OK CR LF - command carried out

ES CR LF - command not recognised (mass format incorrect)

#### **Give value of min checkweighing threshold**

Format: **ODH CR LF**

Response: **DH\_MASS CR LF** - command carried out

Response format:

1	2	3	4-12	13	14	15	16	17	18	19
D	H	space	mass	space	unit			space	CR	LF

**Mass** - 9 characters, right justification

**Unit** - 3 characters, left justification

#### **Give value of max checkweighing threshold**

Format: **OUH CR LF**

Response: **UH\_MASS CR LF** - command carried out

Response format :

1	2	3	4-12	13	14	15	16	17	18	19
U	H	space	mass	space	unit			space	CR	LF

**Mass** - 9 characters, right justification

**Unit** - 3 characters, left justification

#### **Set mass value of a single item (for PARTS COUNTING mode)**

Format: **SM\_XXXXX CR LF**, where: \_ - space, **XXXXX** - mass format

Response options:

SM\_OK CR LF - command carried out

SM\_I CR LF - command understood but not accessible at this moment (e.g. mode other than PARTS COUNTING)

ES CR LF - command not recognised (mass format incorrect)

#### **Set target mass value (e.g. DOSING mode)**

Format: **TV\_XXXXX CR LF**, where: \_ - space, **XXXXX** - mass format

Response options:

TV\_OK CR LF - command carried out

TV\_I CR LF - command understood but not accessible at this moment (e.g. mode other than DOSING)

ES CR LF - command not recognised (mass format incorrect)

#### **Set reference mass value (e.g. for PERCENT WEIGHING)**

Format: **RM\_XXXXX CR LF**, where: \_ - space, **XXXXX** - mass format

Response options:

RM\_OK CR LF - command carried out  
RM\_I CR LF - command understood but not accessible at this moment (e.g. mode other than PERCENT WEIGHING)  
ES CR LF - command not recognised (mass format incorrect)

#### **Value release**

Format: **SS CR LF**

Response options:

SS\_OK CR LF - command understood and in progress

Command's function is similar to function of PRINT key located on the instrument panel,

#### **Internal adjustment**

Format: **IC CR LF**

Response options:

IC\_A CR LF - command understood and in progress

IC\_D CR LF - adjustment completed

IC\_A CR LF - command understood and in progress

IC\_E CR LF - time limit exceeded while waiting for a stable measurement result

IC\_I CR LF - command understood but not accessible at this moment

#### **Disable automatic internal adjustment of the mass comparator**

Format: **IC1 CR LF**

Response options:

IC1\_I CR LF - command understood but not accessible at this moment

IC1\_E CR LF - operation disabled, e.g. for verified mass comparator

IC1\_OK CR LF - command carried out

Operation is disabled for verified mass comparators.

For non-verified mass comparators the command disables internal adjustment until it is enabled via IC0 command or until the mass comparator is turned off. The command does not modify settings specifying adjustment start.

#### **Enable automatic internal adjustment of the mass comparator**

Format: **IC0 CR LF**

Response options:

IC0\_I CR LF - command understood but not accessible at this moment

IC0\_OK CR LF - command carried out

Operation is disabled for verified mass comparators.

#### **Give mass comparator serial number**

Format: **NB CR LF**

Response options:

NB\_A\_"x" CR LF - command understood, response: serial number

NB\_I CR LF - command understood but not accessible at this moment

**x** - mass comparator serial number (in between inverted commas)

Example:

Command: NB CR LF - return serial number

Response: NB\_A\_"1234567" - weighing device serial number --"1234567"

#### **Lock mass comparator keypad**

Format: **K1 CR LF**

Response options:

K1\_I CR LF - command understood but not accessible at this moment

K1\_OK CR LF - command carried out

Command locks the mass comparator keypad (proximity sensors, touch panel) until the moment of turning the balance off or until sending K0 command.

### Unlock mass comparator keypad

Format: **K0 CR LF**

Response options:

K0\_I CR LF - command understood but not accessible at this moment

K0\_OK CR LF - command carried out

### Give available working modes

Command overview:

Command returns accessible working modes.

Format: **OMI <CR><LF>**

Response options:

OMI <CR><LF>

n\_ "Mode name" <CR><LF>

: - command carried out, response: accessible working modes

n\_ "Mode name" <CR><LF>

OK <CR><LF>

OMI\_I <CR><LF> - command understood but not accessible at this moment

**Mode name** – parameter, working mode name, inserted in between inverted commas. The name takes form displayed on a particular weighing device screen, it is provided in a currently selected language.

**n** - parameter, decimal value determining working mode number.

#### Caution:

Working modes numbering is identical for each kind of weighing instrument. The numbers are assigned to working modes names.

Some balances give only the number as a response.

#### Example 1:

Command: OMI <CR><LF> - return accessible working modes

Response: OMI <CR><LF>  
2\_ "Parts counting" <CR><LF> - return accessible working modes,  
4\_ "Dosing" <CR><LF> mode number + name  
12\_ "Checkweighing" <CR><LF>  
OK <CR><LF> - command carried out

#### Example 2:

Command: OMI <CR><LF> - return accessible working modes

Response: OMI <CR><LF>  
2 <CR><LF> - return accessible working modes and mode number,  
4 <CR><LF>  
12 <CR><LF>  
OK <CR><LF> - command carried out

### Set working mode

Command overview:

Command sets particular working mode.

Format: **OMS\_n <CR><LF>**

Response options:

OMS\_OK <CR><LF> - command carried out

OMS\_E <CR><LF> - error in-course of command execution, no parameter or incorrect format

OMS\_I <CR><LF> - command understood but not accessible at this moment

**n** - parameter, decimal value determining working mode number. To see detailed description go to OMI command.

Example:

Command: OMS\_13<CR><LF> - set STATISTICS mode

Response: OMS\_OK<CR><LF> - STATISTICS mode set

### Give current working mode

Command overview:

Command returns accessible working modes.

Format: **OMG <CR><LF>**

Response options:

OMG\_n\_OK <CR><LF> - command carried out, response: current working mode

OMG\_I <CR><LF> - command understood but not accessible at this moment

**n** - parameter, decimal value determining working mode number. To see detailed description go to OMI command.

Example:

Command: OMG<CR><LF> - return current working mode

Response: OMG\_13\_OK<CR><LF> - balance set to STATISTICS mode

### Give accessible units

Command overview:

Command returns units available for a particular device and for a current working mode.

Format: **UI <CR><LF>**

Response options:

UI\_ "x<sub>1</sub>,x<sub>2</sub>, ... x<sub>n</sub>"\_OK<CR><LF> - command carried out, returns accessible units

UI\_I <CR><LF> - command understood but not accessible at this moment

**X** - unit symbols, separated by means of commas.

**x** → g, mg, ct, lb, oz, ozt, dwt, tlh, tls, tlt, tlc, mom, gr, ti, N, baht, tola, u1, u2

Example:

Command: UI <CR><LF> - return available units

Response: UI\_"g, mg, ct"\_OK<CR><LF> - response: available units

### Set current unit

Command overview:

Command sets current unit for a particular device.

Format: **US\_x <CR><LF>**

Response options:

US\_x\_OK <CR><LF> - command carried out, returns accessible units

US\_E <CR><LF> - error in-course of command execution, no parameter or incorrect format

US\_I <CR><LF> - command understood but not accessible at this moment

**x** - parameter, units symbols: g, mg, ct, lb, oz, ozt, dwt, tlh, tls, tlt, tlc, mom, gr, ti, N, baht, tola, msg, u1, u2, next.

**Caution:**

If x=next the command swaps to another available unit on the list (it simulates  button pressing).

Example:

Command: US\_mg<CR><LF> - set „mg” unit  
Response: US\_mg\_OK<CR><LF> - „mg” set as a current unit

### Give current unit

Command overview:

Command returns current unit.

Format: **UG <CR><LF>**

Response options:

**UG\_x\_OK<CR><LF>** - command carried out, returns accessible units

**UG\_I <CR><LF>** - command understood but not accessible at this moment

**x** - parameter, units symbols:

Example:

Command: UG<CR><LF> - return current unit  
Response: UG\_ct\_OK<CR><LF> - currently set unit is „ct”

### Activate sound signal

Command overview:

Command activates BEEP sound signal for a specified amount of time.

Format: **BP\_TIME<CR><LF>**

Response options:

**BP\_OK<CR><LF>** - command carried out, BEEP activated

**BP\_E” <CR><LF>** - no parameter or incorrect format

**BP\_I <CR><LF>** - command understood but not accessible at this moment

**TIME** - parameter, decimal value specifying how long shall the sound last, parameter given in [ms].  
Recommended range <50÷ 5000>.

If value greater than the permissible high limit is given, then BEEP sound is operated for the maximum permissible amount of time.

Example:

Command: BP\_350<CR><LF> - activate BEEP for 350 ms  
Response: BP\_OK<CR><LF> - BEEP activated

#### Caution:

BEEP sound activated via BP command is inhibited if in-course of its activation the sound is activated by means of other device: keypad, touch panel, proximity sensors.

### Send all implemented commands

Format: **PC CR LF**

Command: **PC CR LF** - send all implemented commands  
Response: **PC\_A\_”Z,T,S,SI...”** - command carried out, the terminal displays all implemented commands.

### Give mass comparator type

Format: **BN <CR><LF>**

Response options:

**BN\_A\_”x” <CR><LF>** - command understood, response: weighing device type

**BN\_I <CR><LF>** - command understood but not accessible at this moment

**x** - weighing device type (inserted in between inverted commas), with general balance type in front.

Example:

Command: BN <CR><LF> - give mass comparator type  
Response: BN\_A\_"AS" - mass comparator type - "XA 4Y"

### Give max capacity

Format: **FS** <CR><LF>

Response options:

FS\_A\_"x" <CR><LF> - command understood, response: Max capacity  
FS\_I <CR><LF> - command understood but not accessible at this moment

**x** - Max value of reading units (in between inverted commas)

Example:

Command: FS <CR><LF> - command understood, response: Max capacity  
Response: FS\_A\_"220.0000" - max capacity - "220 g"

### Give program version

Format: **RV** <CR><LF>

Response options:

RV\_A\_"x" <CR><LF> - command understood, response: program version  
RV\_I <CR><LF> - command understood but not accessible at this moment

**x** - program version (in between inverted commas)

Example:

Command: RV <CR><LF> - return program version  
Response: RV\_A\_" 1.1.1" - program version: "1.1.1"

### Set AUTOZERO function

Format: **A\_n** <CR><LF>

Response options:

A\_OK<CR><LF> - command carried out  
A\_E <CR><LF> - error in-course of command execution, no parameter or incorrect format  
A\_I <CR><LF> - command understood but not accessible at this moment

**n** - parameter, decimal value determining autozero settings

n → 0 – autozero off

1 – autozero on

#### Caution:

Command changes settings for a current working mode.

Example:

Command: A\_1<CR><LF> - turn autozero function on  
Response: A\_OK<CR><LF> - autozero function is on

AUTOZERO function operates until it is turned off by A 0 command.

### Set ambient conditions state

Format: **EV\_n** <CR><LF>

Response options:

EV\_OK<CR><LF> - command carried out  
EV\_E <CR><LF> - error in-course of command execution, no parameter or incorrect format  
EV\_I <CR><LF> - command understood but not accessible at this moment

**n** - parameter, decimal value determining ambient conditions state

n → 0 – unstable ambient conditions

1 – stable ambient conditions

**Caution:**

Command changes settings for a current working mode.

Example:

Command: EV\_1<CR><LF> - set value 'stable' for ambient conditions option

Response: EV\_OK<CR><LF> - set value 'stable' for ambient conditions option

<AMBIENT CONDITIONS> parameter is set to value <STABLE> until command EV 0 swaps it to value <UNSTABLE>.

**Set filter**

Format: **FIS\_n <CR><LF>**

Response options:

FIS\_OK<CR><LF> - command carried out

FIS\_E <CR><LF> - error in-course of command execution, no parameter or incorrect format

FIS\_I <CR><LF> - command understood but not accessible at this moment

**n** - parameter, decimal value determining filter number.

n → 1 – very fast

2 – fast

3 – average

4 – slow

5 – very slow

**Caution:**

The numbering is assigned to a particular filter name and it is identical for all balance types.

The command changes settings for a current working mode if, for a particular mass comparator type, filter settings are assigned to the working mode.

Example:

Command: FIS\_3<CR><LF> - set average filter

Response: FIS\_OK<CR><LF> - average filter set

**Set value release**

Format: **ARS\_n <CR><LF>**

Response options:

ARS\_OK<CR><LF> - command carried out

ARS\_E <CR><LF> - error in-course of command execution, no parameter or incorrect format

ARS\_I <CR><LF> - command understood but not accessible at this moment

**n** - parameter, decimal value determining value release options

n → 1 – fast

2 – fast + reliable

3 – reliable

**Caution:**

The numbering is assigned to a particular value release option and it is identical for all balance types.

The command changes settings for a current working mode if, for a particular mass comparator type, filter settings are assigned to the working mode.

Example:

Command: ARS\_2<CR><LF> - set value release parameter to fast+reliable option

Response: ARS\_OK<CR><LF> - fast+reliable option set

**Set last digit**

Format: **LDS\_n <CR><LF>**

Response options:

LDS\_OK<CR><LF> - command carried out  
LDS\_E <CR><LF> - error in-course of command execution, no parameter or incorrect format  
LDS\_I <CR><LF> - command understood but not accessible at this moment

**n** - parameter, decimal value determining last digit settings

n → 1 – always  
2 – never  
3 – when stable

**Caution:**

The numbering is assigned to a particular last digit option and it is identical for all balance types. The command changes settings for a current working mode if, for a particular mass comparator type, filter settings are assigned to the working mode.

Example:

Command: LDS\_1<CR><LF> - set last digit option to value 'always'  
Response: LDS\_OK<CR><LF> - 'always' value set

**Operator logging**

Format: **LOGIN\_Name, Password CR LF**

where: \_ - space (enter name and password in a form provided by the balance – *lower-case letters and upper-case letters*).

Response options:

LOGIN OK CR LF - command understood, new operator logged in  
LOGIN ERROR CR LF - command understood, an error in name or password occurred, log in failed  
ES CR LF - command not recognized (error in format)

**Operator logout**

Format: **LOGOUT CR LF**

Response options:

LOGOUT OK CR LF - command understood, operator is logged out  
ES CR LF - command not recognized (error in format)

**Give accessible units**

Command overview:

Command returns units available for a particular device and for a current working mode.

Format: **UI <CR><LF>**

Response options:

UI\_”x<sub>1</sub>,x<sub>2</sub>, ... x<sub>n</sub>”\_OK<CR><LF> - command carried out, returns accessible units  
UI\_I <CR><LF> - command understood but not accessible at this moment

**X** - unit symbols, separated by means of commas.

**x** → g, mg, ct, lb, oz, ozt, dwt, t/h, t/s, t/t, t/c, mom, gr, ti, N, baht, tola, u1, u2

Example:

Command: UI <CR><LF> - return available units  
Response: UI\_”g, mg, ct”\_OK<CR><LF> - response: available units

**Set current unit**

Command overview:

Command sets current unit for a particular device.

Format: **US\_x <CR><LF>**



Response options:

**US\_x\_OK <CR><LF>** - command carried out, returns accessible units

**US\_E <CR><LF>** - error in-course of command execution, no parameter or incorrect format

**US\_I <CR><LF>** - command understood but not accessible at this moment

**x** - parameter, units symbols: g, mg, ct, lb, oz, ozt, dwt, tlh, tls, tlt, tlc, mom, gr, ti, N, baht, tola, msg, u1, u2, next

**Caution:**

If x=next the command swaps to another available unit on the list (it simulates  button pressing).

Example:

Command: US\_mg<CR><LF> - set „mg” unit

Response: US\_mg\_OK<CR><LF> - „mg” set as a current unit

### Give current unit

Command overview:

Command returns current unit.

Format: **UG <CR><LF>**

Response options:

**UG\_x\_OK<CR><LF>** - command carried out, returns accessible units

**UG\_I <CR><LF>** - command understood but not accessible at this moment

**x** - parameter, units symbols:

Example:

Command: UG<CR><LF> - return current unit

Response: UG\_ct\_OK<CR><LF> - currently set unit is „ct”

### Cooperation with PUE 7.1, PUE 10 indicator

Format: **NT CR LF**

Response options:

ES CR LF - command not recognised (mass format incorrect)

MASS FRAME - command carried out, immediate response: mass value in basic measuring unit

Response format :

1	2	3	4	5	6	7	8	9-18	19	20-22	23	24-32	33	34-36	37	38	39	40
N	T	space	Stability marker	Zero marker	Range marker	Digit marker	space	mass	space	Mass unit	space	tare	space	Tare unit	space	current digits quantity	CR	LF

**NT** - command

**Stability marker** - [space] if stable, [?] if unstable

**Zero marker** - [space] for any value but zero, [Z] for zero value

**Range marker** - marker informing on range within which mass value is comprised: [space] I range balance, [2] II balance, [3] III balance

**Digit marker** - [zero] no digit, [1] one digit marker, [2] two digits marker, [3] three digits marker, [4] four digits marker, [5] five digits marker

- Mass** - 10 characters for net mass given in adjustment unit (with dot and a floating-point “-“ sign ) with right justification
- Mass unit** - 3 characters, left justification
- Tare** - 9 characters with dot - right justification (when floating-point tare gets turned off automatically then zero value is sent)
- Tare unit** - 3 characters, left justification
- Hidden digits quantity** - number specifying quantity of hidden digits: [space] when no digits are hidden, [1] when 1 digit is hidden

**Example:**

**NT CR LF** - command sent from a computer

**N T \_ ? \_ \_ 0 \_ \_ \_ \_ - 5 . 1 1 3 \_ g \_ \_ \_ \_ \_ 0 . 0 0 0 \_ g \_ \_ \_ 0 CR LF**

- command carried out, response: mass value and remaining data

where: \_ - space

### 24.3. Manual Printout/Automatic Printout

The mass comparator enables generating manual and automatic printouts.

- Manual printout: upon indication stabilization press  key.
- Automatic printout is generated automatically in accordance with the settings for automatic printout (read section 14.5 of this user manual).

The content of printout depends on settings of <Standard printout> - <Weighing printout template> menu (read: section 14.5 of this user manual).

**Mass printout format:**

1	2	3	4 -12	13	14	15	16	17	18
stability marker	space	character	mass	space	unit			CR	LF

- Stability marker [space] if stable  
[?] if unstable  
[!] if air buoyancy compensation mode is enabled  
[^] if high limit is out of range  
[v] if low limit is out of range
- Character [space] for positive values  
[-] for negative values
- Mass 9 characters with decimal point, right justification
- Unit 3 characters, left justification

**Example:**

**\_ \_ \_ \_ \_ 1 8 3 2 . 0 \_ g \_ \_ CR LF** - a printout generated from a mass comparator upon pressing  key, according to settings of <Weighing printout template>:

N (measurements quantity)	<b>NO</b>	Universal variable 1 ... 5	<b>NO</b>
Date	<b>NO</b>	Net	<b>NO</b>
Time	<b>NO</b>	Tare	<b>NO</b>
Level status	<b>NO</b>	Gross	<b>NO</b>

Customer	<b>NO</b>	Current result	<b>NO</b>
Warehouse	<b>NO</b>	Supplementary unit	<b>NO</b>
Product	<b>NO</b>	Mass	<b>YES</b>
Packaging	<b>NO</b>	Non-standard printout	<b>NO</b>

## 25. PERIPHERAL DEVICES

Mass comparator can cooperate with the following peripheral devices:

- computer,
- receipt printer: KAFKA, EPSON,
- PCL printer,
- additional display,
- barcode scanner,
- an optional peripheral device operating ASCII communication protocol.

## 26. ERROR MESSAGES

- Err2- Value beyond zero range
- Err3- Value beyond tare range
- Err8- Taring/zeroing operation time exceeded
- NULL- Zero value from converter
- FULL- Measuring range (Max. capacity) exceeded
- LH- Start mass error
- no level- Mass comparator not levelled
- Err 100- Weighing module restart

In process In-course process resulting in unstable measurement (automatic feeder – pills feeding process or comparator – load change process)

## 27. ADDITIONAL EQUIPMENT

Type	Name
P0136	RS232 cable for KAFKA printer
P0151	RS232 cable for EPSON printer
KAFKA	Thermal printer
EPSON	Dot matrix printer
CITIZEN	Label printer
	PCL printer
WD- xx	Additional display in plastic housing
CK-01	Transponder card scanner
LS2208	Barcode scanner
AP2-1	Power loop output
SAL	Anti-vibration bench for XA laboratory balances
	PC keyboard.

### Computer software:

- „LABEL EDITOR”
- „PW-WIN”

- „RAD-KEY”

## 28. APPENDIX A - Variables for Printouts

### 28.1. Variables List

**Caution:**

Each defined variable must be inserted in between curly bracket: {x}, where x – variable number.

List of variables defining non-standard printout templates and data displayed within the workspace:

Symbol	Description
{0} <sup>1)</sup>	Standard printout in a calibration unit
{1} <sup>1)</sup>	Standard printout in a current unit
{2}	Date
{3}	Time
{4}	Date and time
{5}	Working mode
{6}	Net weight in a current unit
{7}	Net weight in adjustment unit
{8}	Gross weight
{9}	Tare
{10}	Current unit
{11}	Adjustment unit
{12}	Low threshold
{13}	High threshold
{15}	Statistics: Number
{16}	Statistics: Sum
{17}	Statistics: Mean
{18}	Statistics: Minimum
{19}	Statistics: Maximum
{20}	Statistics: SDV
{21}	Statistics: D
{22}	Statistics: RDV
{26}	Result control
{27}	Value
{28}	Level status
{30}	Gross

{31}	Weighing platform no.
{32}	Serial number
{33}	Reading unit
{34}	Range
{35}	Parts counting: Reference sample mass
{36}	Percent weighing: Reference mass
{38}	Universal variable: Name
{39}	Universal variable: Value
{43}	Net weight in a supplementary unit
{44}	Supplementary unit
{45}	Target value
{46}	Tolerance
{47}	Difference
{48}	Mass comparator type
{50}	Product: Name
{51}	Product: Code
{52}	Product: EAN code
{53}	Product: Mass
{54}	Product: Tare
{55}	Product: Price
{56}	Product: Minimum
{57}	Product: Maximum
{58} <sup>2)</sup>	Product: PGC mode
{59}	Product: Shelf-life time in days
{60}	Product: VAT
{61}	Product: Date
{62}	Product: Expiry date
{63}	Product: Density
{64}	Product: Ingredients
{65}	Product: Overview
{66}	Product: Tolerance
{75}	Operator: Name
{76}	Operator: Code

{77}	Operator: Permissions
{80}	Packaging: Name
{81}	Packaging: Code
{82}	Packaging: Mass
{85}	Customer: Name
{86}	Customer: Code
{87}	Customer: NIP
{88}	Customer: Address
{89}	Customer: Postal code
{90}	Customer: City
{91}	Customer: Discount
{100} <sup>2)</sup>	PGC Report: Batch number
{101} <sup>2)</sup>	PGC Report: Start date
{102} <sup>2)</sup>	PGC Report: End date
{103} <sup>2)</sup>	PGC Report: Result
{104} <sup>2)</sup>	PGC Report: Batch quantity
{105} <sup>2)</sup>	PGC Report: Measurements quantity
{106} <sup>2)</sup>	PGC Report: Value of T1 error
{107} <sup>2)</sup>	PGC Report: Value of 2T1 error
{108} <sup>2)</sup>	PGC Report: T1 errors quantity
{109} <sup>2)</sup>	PGC Report: Permissible T1 errors quantity
{110} <sup>2)</sup>	PGC Report: 2T1 errors quantity
{111} <sup>2)</sup>	PGC Report: Sum
{112} <sup>2)</sup>	PGC Report: Min
{113} <sup>2)</sup>	PGC Report: Max
{114} <sup>2)</sup>	PGC Report: Mean
{115} <sup>2)</sup>	PGC Report: Average limit
{116} <sup>2)</sup>	PGC Report: Standard deviation
{117} <sup>2)</sup>	PGC Report: Measurements
{118} <sup>2)</sup>	PGC Report: Unit
{119} <sup>2)</sup>	PGC Report: Report no.
{120} <sup>2)</sup>	Average Tare Report: Date
{121} <sup>2)</sup>	Average Tare Report: Result
{122} <sup>2)</sup>	Average Tare Report: Standard deviation

{123} <sup>2)</sup>	Average Tare Report: 0.25T1
{124} <sup>2)</sup>	Average Tare Report: Measurements quantity
{125} <sup>2)</sup>	Average Tare Report: Measurements
{126} <sup>2)</sup>	Average Tare Report: Report no.
{130}	Warehouse: Name
{131}	Warehouse: Code
{132}	Warehouse: Overview
{140}	Additional display: WD
{142}	Additional display: WWG
{143}	Hex
{144}	Hex UTF-8
{146}	Gross weight value in current unit
{147}	Tare in current unit
{150}	PCL printer: Form feed
{151}	Epson printer: Paper crop
{155}	Cooperation with RADWAG CONNECT
{190} <sup>2)</sup>	Comparator: Report no.
{191} <sup>2)</sup>	Comparator: Start date
{192} <sup>2)</sup>	Comparator: End date
{193} <sup>2)</sup>	Comparator: Order number
{194} <sup>2)</sup>	Comparator: Test weight number
{195} <sup>2)</sup>	Comparator: Difference
{196} <sup>2)</sup>	Comparator: List of measurements
{197} <sup>2)</sup>	Comparator: Mean difference
{198} <sup>2)</sup>	Comparator: Standard deviation
{199} <sup>2)</sup>	Comparator: Cycles quantity
{200} <sup>2)</sup>	Comparator: Method
{201} <sup>2)</sup>	Comparator: Min temperature
{202} <sup>2)</sup>	Comparator: Max temperature
{203} <sup>2)</sup>	Comparator: Min humidity
{204} <sup>2)</sup>	Comparator: Max humidity
{205} <sup>2)</sup>	Comparator: Min pressure
{206} <sup>2)</sup>	Comparator: Max pressure

{207} <sup>2)</sup>	Comparator: Task
{208} <sup>2)</sup>	Comparator: Selected task
{209} <sup>2)</sup>	Comparator: Measurements
{210}	Adjustment history: Adjustment type
{211}	Adjustment history: Nominal mass
{212}	Adjustment history: Current mass
{213}	Adjustment history: Difference
{214}	Adjustment history: Temperature
{215}	Adjustment history: Level status
{216}	Adjustment history: Weighing platform no.
{219}	Adjustment history: Date and time of recently performed adjustment
{220} <sup>2)</sup>	Mass control: Start date
{221} <sup>2)</sup>	Mass control: End date
{222} <sup>2)</sup>	Mass control: Batch no.
{223} <sup>2)</sup>	Mass control: Mean
{224} <sup>2)</sup>	Mass control: Standard deviation
{225} <sup>2)</sup>	Mass control: Reference sample quantity
{226} <sup>2)</sup>	Mass control: Measurements
{227} <sup>2)</sup>	Mass control: Report no.
{228} <sup>2)</sup>	Mass control: Number of T2M error
{229} <sup>2)</sup>	Mass control: Number of T1M error
{230} <sup>2)</sup>	Mass control: Number of T1P error
{231} <sup>2)</sup>	Mass control: Number of T2P error
{232} <sup>2)</sup>	Mass control: T2- threshold
{233} <sup>2)</sup>	Mass control: T1- threshold
{234} <sup>2)</sup>	Mass control: T1+ threshold
{235} <sup>2)</sup>	Mass control: T2+ threshold
{236} <sup>2)</sup>	Mass control: T2- threshold value
{237} <sup>2)</sup>	Mass control: T1- threshold value
{238} <sup>2)</sup>	Mass control: T1+ threshold value
{239} <sup>2)</sup>	Mass control: T2+ threshold value
{240} <sup>2)</sup>	Mass control: Average in percent (DX)
{241} <sup>2)</sup>	Mass control: Standard deviation in percent
{250}	Density: Start date
{251}	Density: End date



{252}	Density: Procedure
{253}	Density: Standard liquid
{254}	Density of standard liquid
{255}	Density: Temperature of standard liquid
{256}	Density: Sinkers volume
{257}	Density: Density determined
{258}	Density: Unit
{259}	Density: Sample no.
{260}	Density: Weighing 1
{261}	Density: Weighing 2
{263}	Density: Volume
{266}	Density: Mass of steel standard
{267}	Density: Mass of aluminium standard
{268}	Density: Density of steel standard
{269}	Density: Density of aluminium standard
{275}	Ambient conditions report: Date and time
{276}	Ambient conditions report: THB Temperature
{277}	Ambient conditions report: THB humidity
{278}	Ambient conditions report: Temperature 1
{279}	Ambient conditions report: Temperature 2
{280}	Ambient conditions report: THB pressure
{281}	Ambient conditions report: Air density
{282}	Ambient conditions report: Humidity
{283}	Ambient conditions report: Pressure
{285} <sup>2)</sup>	Mass comparator: Reference weights: Name
{286} <sup>2)</sup>	Mass comparator: Reference weights: Code
{287} <sup>2)</sup>	Mass comparator: Reference weights: Class
{288} <sup>2)</sup>	Mass comparator: Reference weights: Serial number
{289} <sup>2)</sup>	Mass comparator: Reference weights: Mass
{290} <sup>2)</sup>	Mass comparator: Reference weights: Set no.
{295}	Animal weighing: Threshold
{296}	Animal weighing: Averaging time
{300} <sup>2)</sup>	Tasks: Name

{301} <sup>2)</sup>	Tasks: Code
{302} <sup>2)</sup>	Tasks: Class
{303} <sup>2)</sup>	Tasks: Mass
{304} <sup>2)</sup>	Tasks: Order number
{305} <sup>2)</sup>	Tasks: Test weight number
{310}	Pipettes: Name
{311}	Pipettes: Code
{312}	Pipettes: Model
{313}	Pipettes Tips
{314}	Pipettes: Nominal volume
{315}	Pipettes: Minimum volume
{316}	Pipettes: Channels quantity
{317}	Pipettes: Type
{318}	Pipettes: Volume type
{319}	Pipettes: Tested volumes
{325}	Pipette calibration report: Serial no.
{326}	Pipette calibration report: Start date
{327}	Pipette calibration report: End date
{328}	Pipette calibration report: Measurements quantity
{329}	Pipette calibration report: Cooperation in accordance with ISO 8655
{330}	Pipette calibration report: Status
{331}	Pipette calibration report: Temperature
{332}	Pipette calibration report: Humidity
{333}	Pipette calibration report: Pressure
{334}	Pipette calibration report: Water temperature
{335}	Pipette calibration report: Z coefficient
{336}	Pipette calibration report: Statistics
{337}	Pipette calibration report: Measurements and statistics
{338}	Pipette calibration report: Channel no.
{340}	Pipette calibration report: Average volume
{341}	Pipette calibration report: Systematic error
{342}	Pipette calibration report: Random error
{343}	Pipette calibration report: Tested volume
{344}	Pipette calibration report: Systematic error [%]
{345}	Pipette calibration report: Random error [%]

{350}	Lot: Name
{351}	Lot: Code
{352}	Lot: Samples
{353}	Lot: Samples quantity
{355}	Sample: Name
{356}	Sample: Status
{357}	Sample: Tare
{358}	Sample: Temperature
{359}	Sample: Humidity
{360}	Sample: Pressure
{361}	Sample no.
{365}	Weighing B: Interval
{366}	Weighing B: Difference
{367}	Weighing B: Difference %
{368}	Weighing B: Residue %
{369}	Weighing B: Number
{375}	Differential weighing: Method
{380} <sup>2)</sup>	Drying program: Name
{381} <sup>2)</sup>	Drying program: Code
{385} <sup>2)</sup>	Drying mode
{386} <sup>2)</sup>	Drying mode parameters
{387} <sup>2)</sup>	Finish mode
{388} <sup>2)</sup>	Finish mode parameters
{389} <sup>2)</sup>	Drying report: Unit
{390} <sup>2)</sup>	Drying report: Printout interval
{395} <sup>2)</sup>	Moisture analyzer: Set temperature
{396} <sup>2)</sup>	Moisture analyzer: Current temperature
{397} <sup>2)</sup>	Moisture analyzer: Drying time
{398} <sup>2)</sup>	Moisture analyzer: Status

{399} <sup>2)</sup>	Moisture analyzer: Drying time and result
{400} <sup>2)</sup>	Moisture analyzer: Humidity content
{401} <sup>2)</sup>	Moisture analyzer: Dry content
{402} <sup>2)</sup>	Moisture analyzer: Humid/Dry ratio
{403} <sup>2)</sup>	Moisture analyzer: Heating source test – Power [%]
{405}	SQC : Batch number
{406}	SQC : Start date
{407}	SQC : End date
{408}	SQC : Batch quantity
{410}	SQC : Mean
{411}	SQC : Standard deviation
{412}	SQC : MIN
{413}	SQC : MAX
{414}	SQC : Difference
{415}	SQC : Measurements
{416}	SQC : Mean [%]
{417}	SQC : Standard deviation [%]
{418}	SQC : T2- errors quantity
{419}	SQC : T1- errors quantity
{420}	SQC : T1+ errors quantity
{421}	SQC : T2+ errors quantity
{422}	SQC : T2- threshold
{423}	SQC : T1- threshold
{424}	SQC : T1+ threshold
{425}	SQC : T2+ threshold
{426}	SQC : T2- threshold value
{427}	SQC : T1- threshold value
{428}	SQC : T1+ threshold value
{429}	SQC : T2+ threshold value
{440}	Minimum sample weight: Name
{441}	Minimum sample weight: Reference tare
{442}	Minimum sample weight
{443}	Minimum sample weight: Status

**Caution:**

- 1) Format of variables {0} and {1} is finished with **CR LF** characters (i.e. switching to a next line is carried out automatically),
- 2) Variables are not operated by software version: **Standard**.

**28.2. Variables Formatting**

You can randomly format numerical variables, text variables and date which are dedicated for printing, and which are displayed in the grey workspace of the display.

**Formatting types:**

- variables with left justification,
- variables with right justification,
- determining quantity of characters for printing / displaying,
- determining quantity of decimal places for numerical variables,
- converting the format of date and hour,
- converting numerical variables into EAN13 code
- converting numerical variables and date into EAN128 code

**Special formatting characters:**



<b>Character</b>	<b>Overview</b>	<b>Example</b>
,	Sign separating variables for formatting	<b>{7,10}</b> - Net weight in adjustment unit with constant length of 10 characters, with right justification
-	Minus sign or left justification	<b>{7,-10}</b> - Net mass in adjustment unit with constant length of 10 characters, with left justification
:	Sign proceeding formatting or time separator (i.e. hours, minutes and seconds)	<b>{7:0.000}</b> - Net mass in adjustment unit always with three decimal places; <b>{3:hh:mm:ss}</b> – Current time in format: hour : minute : second.
.	First detected dot in a digit is recognized as separator of integer and decimal parts. Each following dot is ignored.	<b>{55:0.00}</b> - Product's unit price always with two decimal places; <b>{17:0.0000}</b> – Measurements average, always with four decimal places;
<b>F</b>	Sign formatting digits to a chain of sign in format “-ddd.ddd...” (where: d stands for a single digit, minus is for digits with negative value only) or determining number of decimal places	<b>{7:F2}</b> - Net mass in adjustment unit always with two decimal places; <b>{7,9:F2}</b> - Net mass in adjustment unit always with two decimal places and fixed length of 9 characters with right justification;
<b>V</b>	Formatting mass and quantities derivatives of mass in EAN13 code	<b>{7:V6.3}</b> - Net mass in a form of EAN13 code (6-character code) with three decimal places
<b>T</b>	Formatting mass and quantities derivatives of mass in EAN128 code	<b>{7:T6.3}</b> - Net mass in a form of EAN128 code with three decimal places;
/	Date separator between days, months and years	<b>{2:yy/MM/dd}</b> - Current date in format: year - month - day, where <b>yy</b> stand for two less meaningful characters of a year;

\	Sign “escape” deleting a formatting function from the following sign, so that it is recognized as text	<b>{2:yy/MMVdd}</b> – Current date in format: year / month / day. <b>{2:yy\MM\dd}</b> - Current date in format: year : month : day. Should „\” be used in literal meaning, insert \\;
---	--	---

**Application list of formatted variables:**

<b>CODE</b>	<b>OVERVIEW</b>
{7:V6.3}	Net mass in EAN 13 code (6-character code)
{7:V7.3}	Net mass in EAN 13 code (7-character code)
{27:V6.3}	Net value in EAN 13 code (6-character code)
{27:V7.3}	Net value in EAN 13 code (7-character code)
{7:T6.3}	Net mass in EAN 128 code
{8:T6.3}	Gross mass in EAN 128 code
{55:T6.2}	Product price in EAN 128 code
{2:yyMMdd}	Data in EAN 128 code
{61:yyMMdd}	Product data in EAN 128 code
{62:yyMMdd}	Product’s shelf-life time in EAN 128 code

## 29. APPENDIX B – Programmable Buttons List

Pictogram	Name	Pictogram	Name
-	None		Footer printout
	Automatic Weight Crane Control		Units
	Task		Edit universal variable 1
	Reference weight		Edit universal variable 2
	Comparison procedure		Edit universal variable 3
	Profile		Edit universal variable 4
	Adjustment		Edit universal variable 5
	Zero		Accept
	Tare		Abort
	Set tare		Operator
	Disable tare		Left door opening/closing
	Enable tare		Right door opening/closing
	Packaging		Open/close door
	Print		Parameters
	Header printout		Products
	Warehouses		Customers

	Working modes		Help
	Videos		

### 30. APPENDIX C - CITIZEN Printer Settings

Baud rate     **9600b/sec**  
 Parity         **none**  
 Bits           **8bit**  
 Stop bits     **1 bit**  
 Handshake    **none**  
 IEEE 1284    **ON (enabled)**

Printout data regarding RS232:

[Interface Menu]

RS-232C Baud rate     **9600bps**  
 RS-232C Parity        **None**  
 RS-232C Length       **8 bit**  
 RS-232C Stop bit     **1 bit**  
 RS-232C X-ON         **No**  
 IEEE 1284             **On**

For detailed information on activating an information (test) printout and carrying out changes refer to CITIZEN printer user manual.

### 31. APPENDIX D - ZEBRA Printer Settings

Baud rate     **9600b/sec**  
 Parity         **none**  
 Bits           **8bit**  
 Stop bits     **1 bit**

Printout data regarding RS232:

Serial port : **96, N, 8, 1**

For detailed information on activating an information (test) printout and carrying out changes ZEBRA printer user manual.

### 32. APPENDIX E - Communication with Barcode Scanner

1. For communication with RADWAG barcode scanners use RS232 interfaces and simplex transmission (one -way direction) without handshaking. For this purpose, use of second line of the cable is sufficient. Transmission parameters can be set for both weighing devices and scanners.
2. Both mass comparator and scanners have the possibility of setting of transmission parameters. For both devices the following parameters must comply: baud rate, data bits quantity, parity control, stop bits quantity; e.g. 9600,8,N,1 – baud rate 9600 bit/s, data 8-bits, no parity control, 1 stop bit.
3. Barcode scanners can send additional information apart from the expected barcode; e.g. symbology (type of barcode). Due to the fact that RADWAG devices and software do not use such information, it is advisable to disable it.
4. Some RADWAG systems can omit unnecessary information by using parameters that mark the beginning and the length of the code required to analysis.



5. A special protocol is required in order the code be received by RADWAG equipment. It is required to program an appropriate *prefix* and *suffix*. In RADWAG-adopted standard, the prefix is 01 sign (byte) hexadecimal format, the suffix is 0D sign (byte) hexadecimal format.
6. Most barcode scanners allow to enable/disable different symbologies (barcode types).
7. Programming of scanners is usually performed by reading special barcodes or by using an external software tool.

Barcode with required prefix and suffix in hexadecimal format	Barcode without required – fixes in ASCII format	Code type
01 30 30 32 31 30 31 32 36 0D	00210126	EAN-8
01 30 31 32 33 34 35 36 37 38 39 0D	0123456789	CODE 2 OF 5
01 43 4F 44 45 20 33 39 20 54 45 53 54 0D	CODE 39 TEST	CODE 39
01 31 31 30 31 32 33 34 35 36 37 38 39 31 0D	1101234567891	EAN-13
01 43 6F 64 65 20 31 32 38 20 54 65 73 74 0D	CODE 128 Test	CODE 128

### 33. APPENDIX F – Menu Structure

#### User adjustment

Overview	Value
Internal adjustment	Function
External adjustment	Function
User adjustment	Function
Adjustment Test	Function
Automatic adjustment time	1 - 12
Report printout	No / Yes
GLP Project. . →→	

	Name	Selection
»	Adjustment	No / Yes
»	Working mode	No / Yes
»	Date	No / Yes
»	Time	No / Yes
»	Operator	No / Yes
»	Mass comparator type	No / Yes
»	Mass comparator S/N	No / Yes
»	Level status	No / Yes
»	Nominal mass	No / Yes
»	Difference	No / Yes
»	Temperature	No / Yes
»	Current mass	No / Yes

»	Empty line	No / Yes
»	Dashes	No / Yes
»	Signature	No / Yes
»	Non-standard printout	No / Yes
Adjustment history	Displays a report on completed external adjustments	

## Communication

Overview		Value
COM 1		-
»	Speed	9600
»	Data bits	8
»	Stop bits	1
»	Parity	None
COM 2		-
»	Speed	9600
»	Data bits	8
»	Stop bits	1
»	Parity	None
Ethernet		-
»	DHCP	No
»	IP Address	192.168.0.2
»	Subnet mask	255.255.255.0
»	Default gateway	192.168.0.1
TCP		-
	Port	4001

## Peripherals

Overview		Value
Computer		-
»	Port	COM 1
»	Address	1
»	Continuous transmission	No / Yes
»	Printout template	Selection

»	E2R System	Selection
Printer		
»	Port	COM 2
»	Code page	1250
»	Printouts	Selection
Barcode scanner		
»	Port	None / COM 1/ COM 2
»	Offset	0
»	Code length	0
Transponder card scanner		
	Port	None / COM 1/ COM 2
Additional display		
	Port	None / COM 1-2 / Tcp
	Project	Selection
Ambient conditions module		
	Port	None / COM 1-2 / Com internal
	Address	3

## Inputs/Outputs

Overview		Value
Inputs		
»	Input 1	Selection
»	Input 2	Selection
»	Input 3	Selection
»	Input 4	Selection
Outputs		
»	Output 1	Selection
»	Output 2	Selection
»	Output 3	Selection
»	Output 4	Selection

## Permissions

Overview		Value
Anonymous operator		
»	Guest	Selection
»	Operator	Selection

»	Advanced operator	Selection
»	Administrator	Selection
Date and time		
»	Guest	Selection
»	Operator	Selection
»	Advanced operator	Selection
»	Administrator	Selection
Printouts		
»	Guest	Selection
»	Operator	Selection
»	Advanced operator	Selection
»	Administrator	Selection
Databases		
	Products	Selection - Operator - Advanced operator
	Customers	
	Packaging	
	Warehouses	
	Printouts	
	Delete data older than	

### Miscellaneous

Overview	Value
Language	Selection
Date and time	Selection
Beep	Selection
Touch panel calibration	Function
Level control	Selection
Autotest	Selection

User manual number:  
IMKO-04-07-12-18-PL





**RADWAG BALANCES AND SCALES**  
ADVANCED WEIGHING TECHNOLOGIES

