

# 4Y Series Balances

UYA 4Y Ultra-Microbalances  
MYA 4Y Microbalances  
MYB 4Y Microbalance  
MYA 4Y.P Microbalances for Pipettes  
MYA 4Y.F Microbalances for Filters  
XA 4Y.M Microbalances  
XA 4Y.M.A Microbalances  
XA 4Y Analytical Balances  
XA 4Y.A Analytical Balances  
XA 4Y.F Analytical Balances for Filters

## USER MANUAL

IMMU-01-27-01-19-EN



Congratulations and thank you for selecting RADWAG product. You have purchased a device that has been designed and manufactured to give you years of service.  
Please read this user manual carefully, this shall guarantee reliable operation.

OCTOBER 2018

## Contents

<b>1. GENERAL INFORMATION</b>	<b>9</b>
1.1. Dimensions	9
1.2. Connectors Arrangement	13
1.3. Intended Use	14
1.4. Precautions	14
1.5. Warranty Conditions	14
1.6. Supervision Over Metrological Parameters	15
1.7. User Manual Significance	15
1.8. Training	15
<b>2. TRANSPORT AND STORAGE</b>	<b>15</b>
2.1. Delivery Check	15
2.2. Packaging	15
<b>3. UNPACKING AND INSTALLATION</b>	<b>15</b>
3.1. Workstation	15
3.2. Unpacking	15
3.3. Standard Delivery Components List	16
3.4. Maintenance Activities	20
3.5. Connecting the Balance to the Mains	24
3.6. Temperature Stabilization Time	24
3.7. Connecting Peripheral Equipment	24
3.8. Balances with Wireless 'Indicator'-'Module' Connection	25
3.8.1. Start-Up	25
3.8.2. Wireless Connection Pictograms	26
3.8.3. Settings	26
3.9. Balances with a Built-In Ioniser	26
<b>4. START-UP</b>	<b>27</b>
<b>5. OPERATION PANEL</b>	<b>28</b>
<b>6. PROGRAM</b>	<b>29</b>
<b>7. WEIGHING RESULT WINDOW</b>	<b>30</b>
<b>8. LOG IN OPERATION</b>	<b>31</b>
<b>9. OPERATING THE MENU</b>	<b>31</b>
9.1. Navigation	31
9.2. Return to the Weighing Mode	32
<b>10. ADJUSTMENT</b>	<b>32</b>
10.1. Internal Adjustment	32
10.2. External Adjustment	33
10.3. User Adjustment	33
10.4. Adjustment Test	33
10.5. Automatic Adjustment	33
10.6. Automatic Adjustment Time	33
10.7. Scheduled Adjustments	34
10.8. Report Printout	36
10.9. GLP Project	36
10.10. Adjustment History	36
<b>11. OPERATORS</b>	<b>37</b>

<b>12. ADMINISTRATOR PANEL .....</b>	<b>37</b>
12.1. Password Settings .....	38
12.2. Operator Account Settings.....	39
12.3. Permissions Management .....	40
<b>13. PROFILES .....</b>	<b>41</b>
13.1. Creating a Profile .....	42
13.2. Profile Structure.....	42
13.2.1. Settings .....	43
13.2.2. Working Modes .....	43
13.2.3. Readout .....	43
13.2.4. Units .....	45
<b>14. WORKING MODES – General Information.....</b>	<b>45</b>
14.1. Running Working Mode .....	47
14.2. Working Mode Parameters.....	47
14.3. Quick Access Buttons, Proximity Sensors.....	47
14.3.1. Proximity Sensors.....	48
14.3.2. Automatically Opened Door.....	48
14.4. Information.....	49
14.5. Printouts.....	49
14.6. Profiles .....	50
<b>15. WEIGHING .....</b>	<b>50</b>
15.1. Weighing Unit Selection .....	50
15.2. Good Weighing Practice .....	51
15.3. Levelling .....	51
15.4. Zeroing .....	52
15.5. Taring .....	52
15.6. Use of Air Buoyancy Compensation Factor .....	53
15.7. Additional Parameters for a Weighing Process .....	55
15.8. Minimum Sample Weight.....	56
15.9. Cooperation with Titrators .....	59
15.10. Ambient Conditions - Vibrations .....	59
<b>16. PARTS COUNTING .....</b>	<b>63</b>
16.1. Mode Related Settings .....	63
16.2. Parts Counting – Quick Access Buttons.....	64
16.3. Setting Reference Sample Mass by Entering Mass of a Single Part.....	64
16.4. Setting Reference Sample Mass by Determining Mass of a Single Part .....	64
16.5. Setting Reference Sample Mass by Acquiring Mass of a Single Part from Database.....	65
16.6. Single Part Mass Update in a Database.....	65
16.7. Parts Counting Procedure .....	65
16.8. Checkweighing for Parts Counting Mode .....	66
16.9. Dosing in Parts Counting Mode.....	66
<b>17. CHECKWEIGHING .....</b>	<b>67</b>
17.1. Making Use of Checkweighing Thresholds .....	67
17.2. Mode Related Settings .....	68
<b>18. DOSING.....</b>	<b>68</b>
18.1. Making Use of Products Database in the Course of Dosing Operation .....	68
18.2. Mode Related Settings .....	69

<b>19. PERCENT WEIGHING AGAINST REFERENCE SAMPLE MASS.....</b>	<b>69</b>
19.1. Sample Mass and Reference Sample Mass Comparison .....	70
19.2. Checkweighing and Dosing in Percent Weighing Mode .....	71
19.3. Bar Graph .....	71
19.4. Mode Related Settings .....	72
<b>20. DENSITY.....</b>	<b>72</b>
20.1. Density Determination Kit .....	73
20.2. Assembly .....	73
20.3. Solids Density Determination .....	73
20.4. Liquids Density Determination.....	74
20.5. Air Density .....	75
20.6. Determining Density Using Pycnometer .....	76
20.7. Mode Related Settings .....	77
20.8. Printouts.....	78
20.9. Performed Density Determinations Report .....	78
<b>21. ANIMAL WEIGHING.....</b>	<b>79</b>
21.1. Animal Weighing Settings.....	79
21.2. Mode Related Settings .....	80
<b>22. FORMULATIONS .....</b>	<b>80</b>
22.1. Mode Related Settings .....	81
22.2. Formulations – Quick Access Buttons .....	81
22.3. Adding Formulation to Formulations Database .....	82
22.4. Using Formulations in Weighing .....	82
22.5. Printouts.....	84
<b>23. STATISTICS.....</b>	<b>85</b>
23.1. Buttons and Information Settings .....	86
23.2. Additional Settings for Statistics .....	86
23.3. Measurement Series Parameters .....	86
<b>24. PIPETTES CALIBRATION .....</b>	<b>88</b>
24.1. Mode Related Settings .....	93
24.2. Pipettes Calibration – Quick Access Buttons .....	94
24.3. Adding a Pipette to Pipettes Database .....	94
24.4. Printouts.....	95
24.5. Pipettes Calibration Start-Up.....	95
24.6. Performed Pipettes Calibrations Report.....	96
<b>25. DIFFERENTIAL WEIGHING .....</b>	<b>98</b>
25.1. Mode Related Settings .....	98
25.2. Differential Weighing - Quick Access Buttons.....	99
25.3. Adding Series to Series Database .....	99
25.4. Differential Weighing Process Example .....	100
25.5. Copy Tare .....	104
25.6. Sample Selection .....	105
25.7. Deleting Values.....	105
25.8. Printouts.....	105
<b>26. STATISTICAL QUALITY CONTROL- SQC .....</b>	<b>106</b>
26.1. SQC Activation .....	107
26.2. Mode Related Settings .....	108

26.3. Control Operation.....	109
26.4. SQC Control Report .....	110
<b>27. PEAK HOLD.....</b>	<b>111</b>
27.1. Mode Related Settings .....	111
27.2. Peak Hold Operation.....	111
<b>28. PRE-PACKAGED GOODS CONTROL .....</b>	<b>112</b>
28.1. PGC Mode Start-Up .....	112
28.2. Control Settings.....	113
28.3. PGC Mode Local Settings.....	113
28.4. Editing Product for Control Process .....	113
28.5. Control Process Start .....	115
28.6. Abort Control Procedure .....	116
28.7. Aborted Control Restoring Procedure, Power Loss Case.....	116
28.8. Non-Destructive Average Tare Control Mode .....	117
28.9. Non-Destructive Empty-Full Control Mode.....	122
28.10. Destructive Empty-Full and Full-Empty Control Mode .....	123
28.11. Control According to Internal Criteria .....	123
28.12. Reports .....	125
<b>29. MASS CONTROL .....</b>	<b>127</b>
29.1. Mass Control Global Settings .....	127
29.2. Mass Control Process .....	127
29.3. Printouts.....	128
29.4. Performed Mass Control Report .....	129
<b>30. DATABASES .....</b>	<b>130</b>
30.1. Database Connected Operations.....	131
30.2. Products .....	132
30.3. Weighing Records .....	133
30.4. Customers .....	133
30.5. Formulations .....	134
30.6. Formulations Reports.....	134
30.7. Density Reports .....	135
30.8. Control Reports.....	135
30.9. SQC Statistics.....	137
30.10. Average Tares .....	139
30.11. Pipettes .....	139
30.12. Pipette Calibration Reports .....	140
30.13. Series .....	140
30.14. Minimum Sample Weight.....	141
30.15. Mass Controls.....	142
30.16. Ambient Conditions .....	143
30.17. Packages .....	144
30.18. Warehouses .....	144
30.19. Printouts.....	144
30.20. Universal Variables.....	146
30.21. Databases Management.....	146
30.21.1. Export Weighing Database to a File .....	146
30.21.2. Delete Databases .....	147
30.21.3. Delete Weighings and Reports .....	148

<b>31. COMMUNICATION</b>	<b>148</b>
31.1. RS232 Ports Settings	149
31.2. ETHERNET Port Settings	149
31.3. Wi-Fi Settings	149
31.4. TCP Settings	150
<b>32. PERIPHERALS</b>	<b>150</b>
32.1. Computer	150
32.2. Printer	151
32.3. Barcode Scanner	153
32.3.1. Barcode Scanner Port	153
32.3.2. Prefix/Suffix	153
32.3.3. Field Selection	154
32.3.4. Test	155
32.4. Transponder Card Reader	155
32.5. Additional Display	156
32.6. Ambient Conditions Module	156
32.7. Automatic Feeder	156
<b>33. INPUTS / OUTPUTS</b>	<b>156</b>
<b>34. MISCELLANEOUS PARAMETERS</b>	<b>158</b>
34.1. Interface Language	158
34.2. Date and Time	158
34.3. „Beep“ Sound	159
34.4. Volume	159
34.5. Sleep Mode	159
34.6. Display Brightness	160
34.7. Touch Panel Calibration	160
34.8. Vibrations Detection	160
34.9. Level Control	160
34.10. Proximity Sensors Sensitivity	161
34.11. Proximity Sensors Timeout	161
34.12. Autotest	161
34.13. Start-Up Logo	165
34.14. Export of System Events	165
<b>35. UPDATE</b>	<b>165</b>
<b>36. ABOUT (system info)</b>	<b>165</b>
<b>37. VIDEOS</b>	<b>166</b>
<b>38. COMMUNICATION PROTOCOL</b>	<b>168</b>
38.1. List of Commands	168
38.2. Response Format	169
38.3. Manual Printout / Automatic Printout	184
<b>39. PERIPHERAL DEVICES</b>	<b>185</b>
<b>40. ERROR MESSAGES</b>	<b>185</b>
<b>41. ADDITIONAL EQUIPMENT</b>	<b>186</b>
<b>42. ANNEX A - Printout Variables</b>	<b>186</b>
42.1. List of Variables	186
42.2. Variables Formatting	196
<b>43. ANNEX B – Programmable Buttons List</b>	<b>197</b>

**44. ANNEX D - ZEBRA Printer Setting ..... 199**  
**45. ANNEX E - Barcode Scanner Settings ..... 199**  
**46. ANNEX F – Menu Structure ..... 200**



# 1. GENERAL INFORMATION

## 1.1. Dimensions

Ultra-microbalances and microbalances

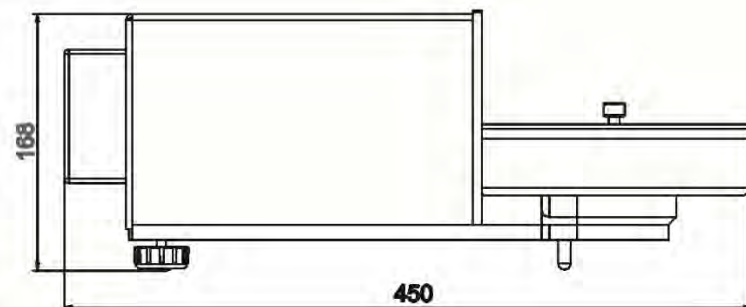
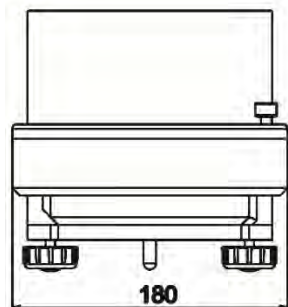
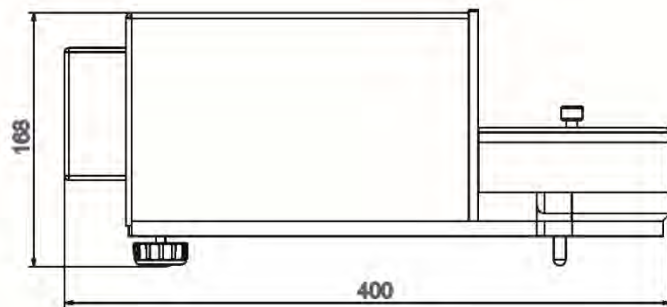
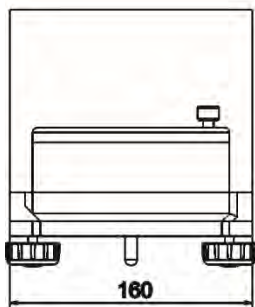
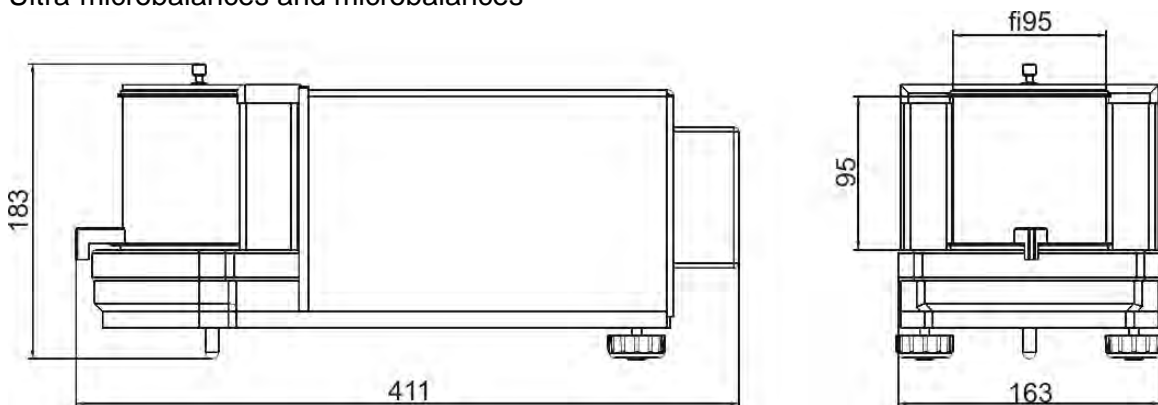

# MYB 4Y Microbalances

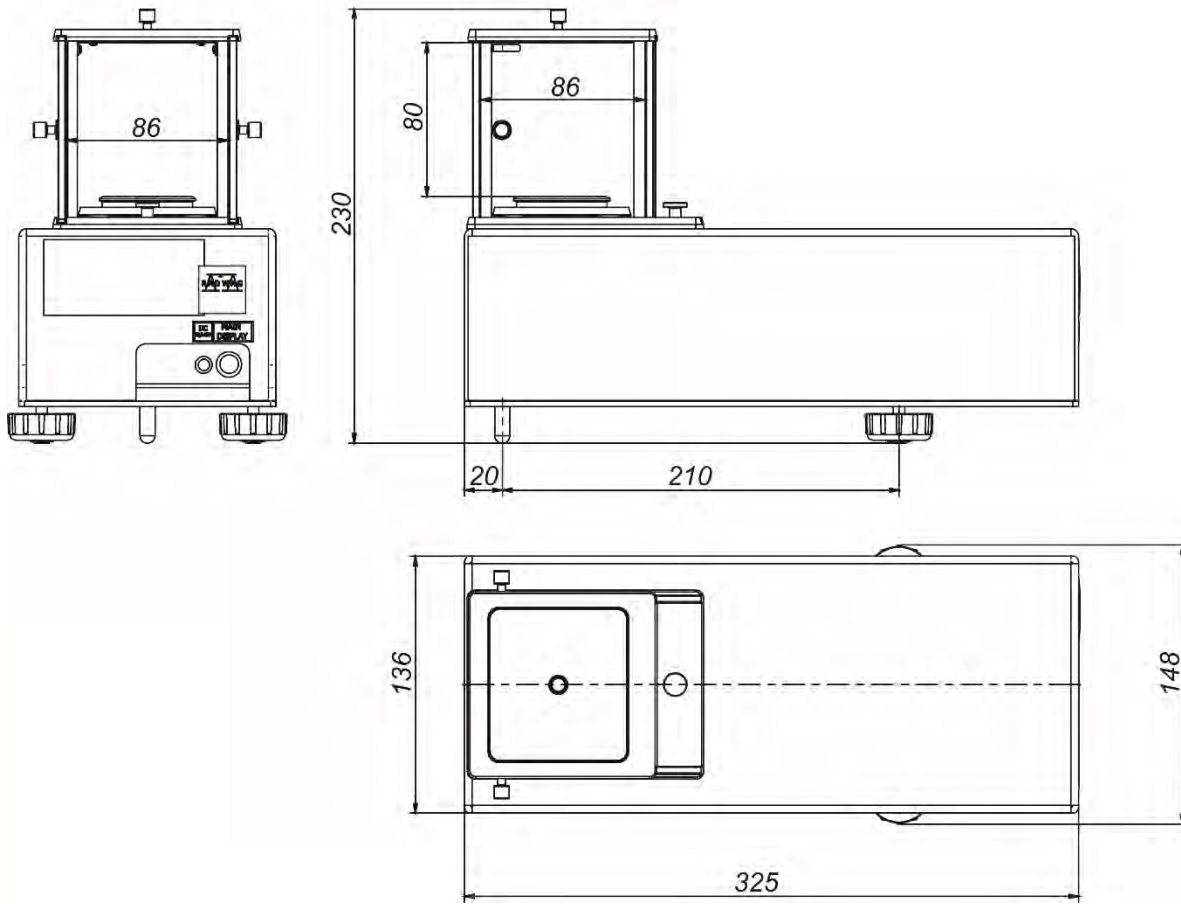

# Indicator

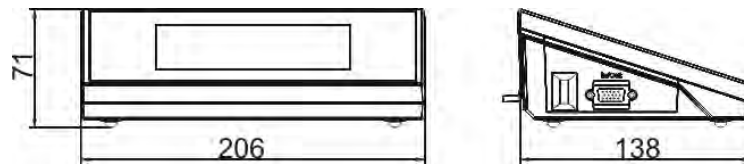

XA 4Y.M.A Microbalances

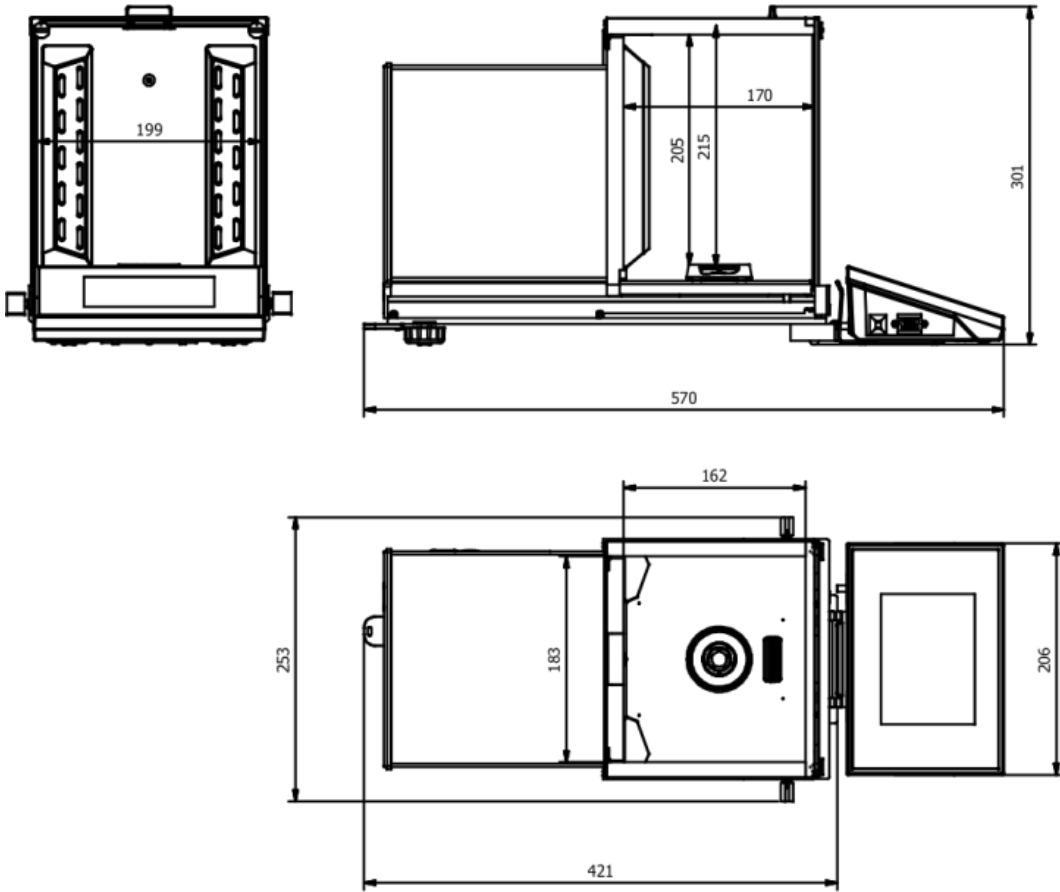

XA 4Y.M Microbalances

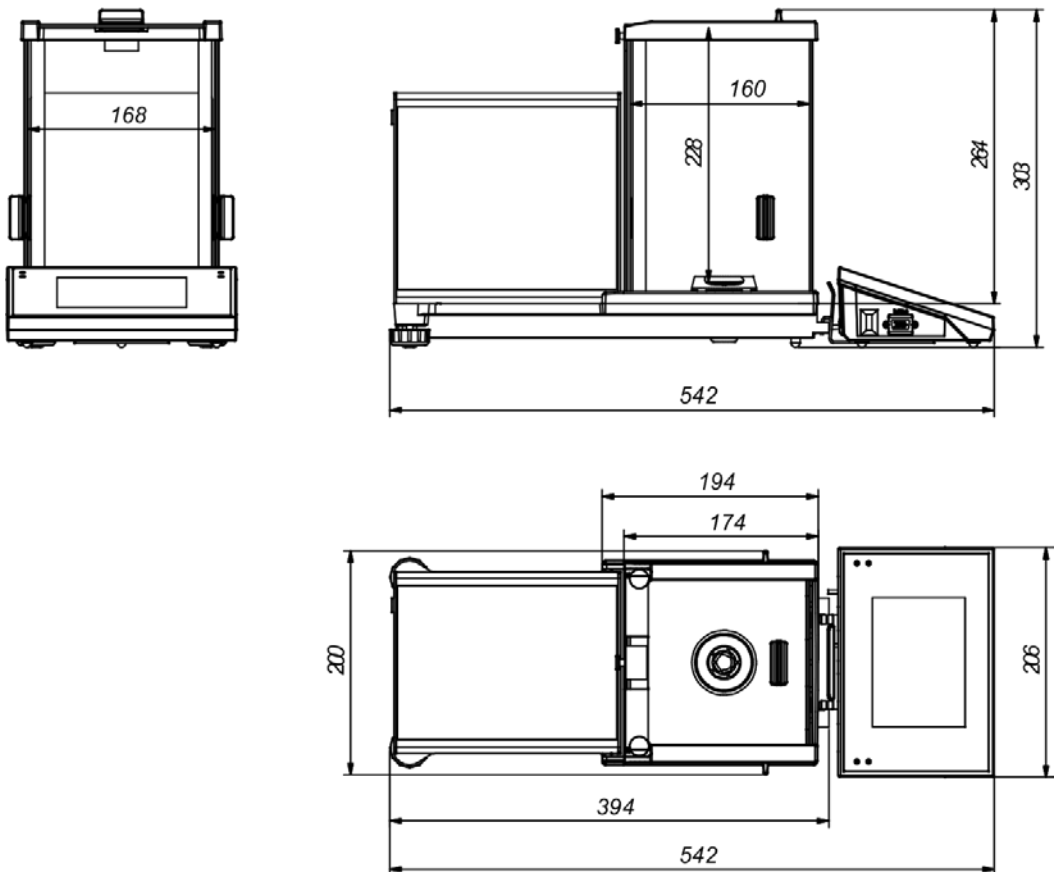

XA 4Y Series Balances, with  $d = 0.1 \text{ mg}$

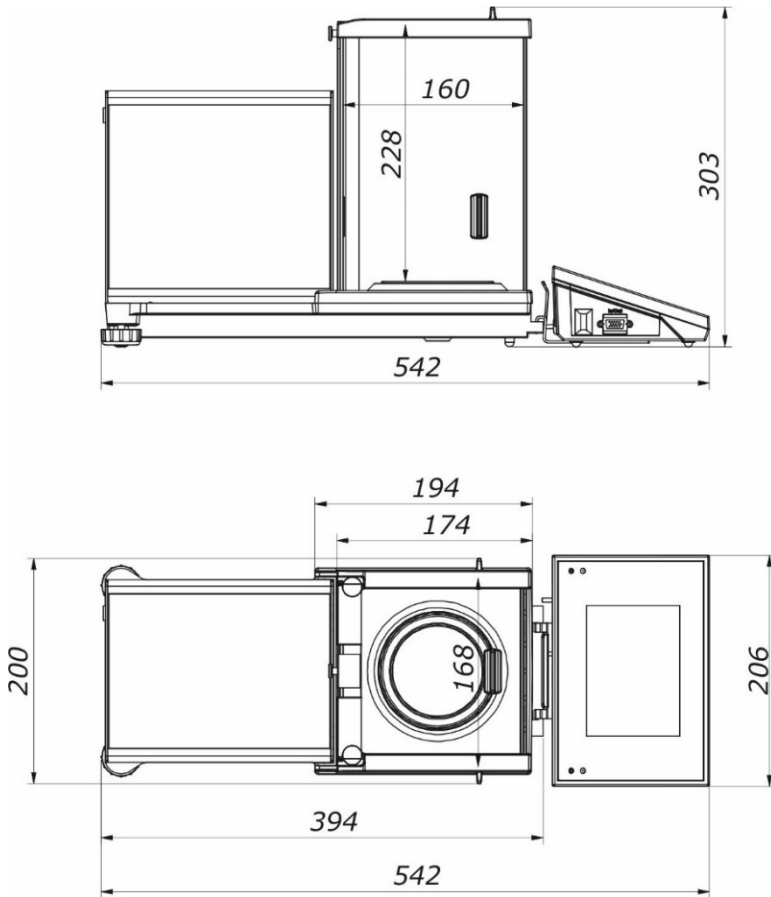

XA 4Y.A Series Balances

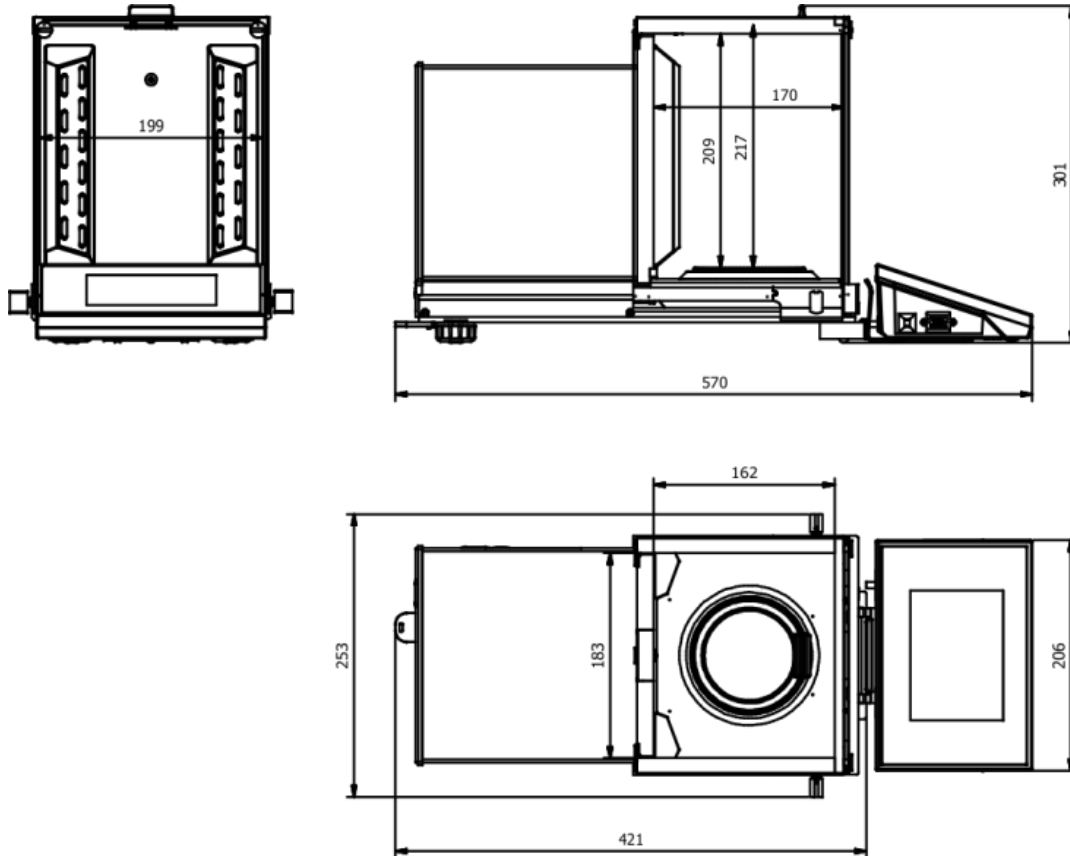

# XA 4Y.F Series Balances

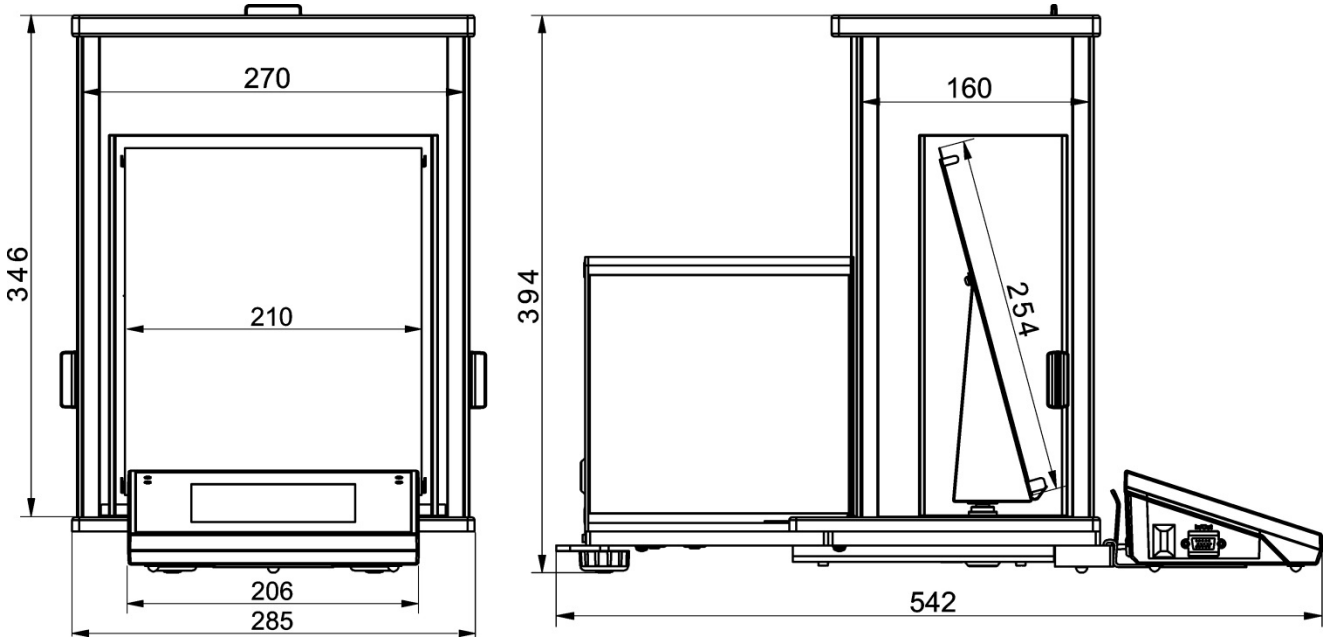

## 1.2. Connectors Arrangement



- 1 – Ethernet RJ45 connector
- 2 – RS232 (COM1) connector
- 3 – USB connector

4 – I/O, RS232 (COM2) connector

**Caution!** 'Ethernet' – 'weighing device' cable is a standard network cable terminated with RJ45 connectors on both ends.

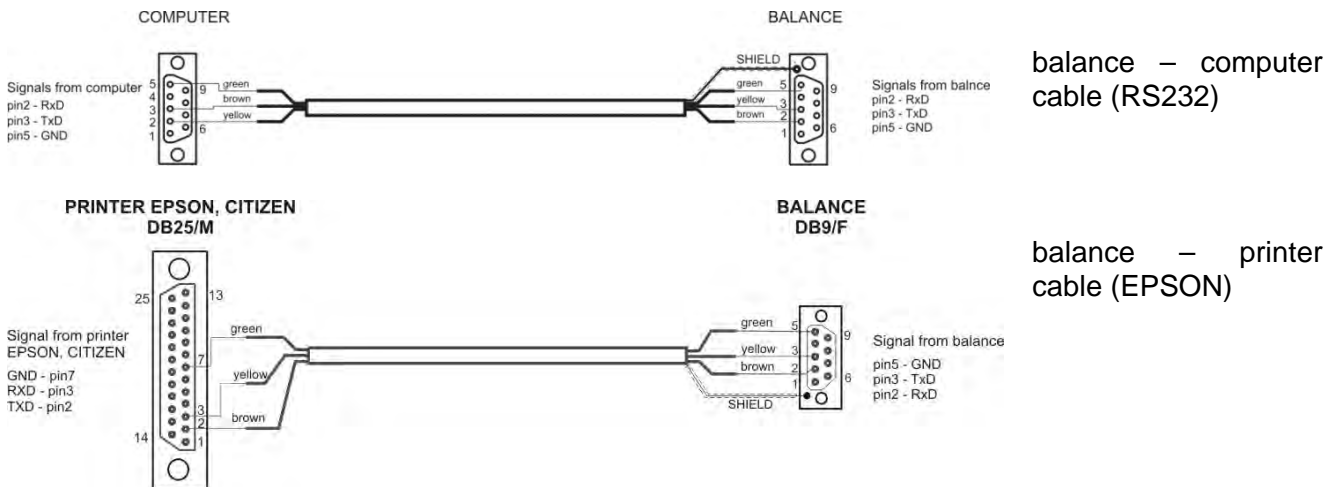

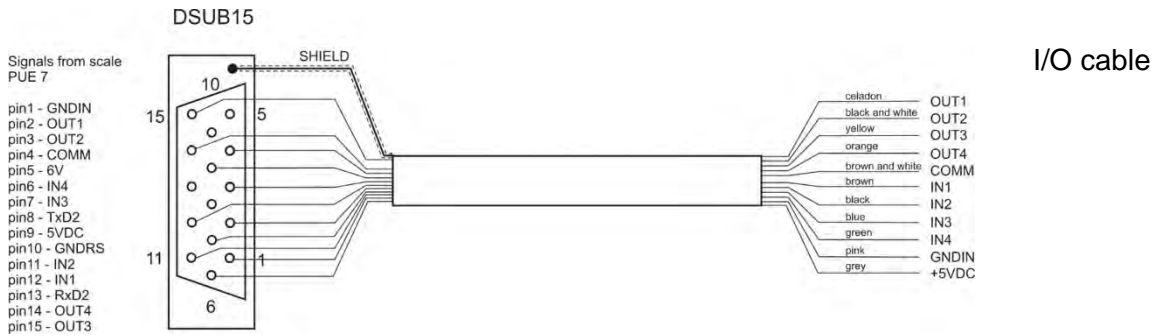

### 1.3. Intended Use

4Y series balances have been designed to enable precise determination of mass in laboratory.

### 1.4. Precautions

1. Prior the first use, carefully read the user manual. Use the device only as intended.
2. Do not operate the touch panel using sharp-edged tools (knife, screwdriver, etc.).
3. Place weighed loads in the centre of the weighing pan.
4. Load the weighing pan with loads of gross weight which does not exceed the maximum capacity.
5. Mind not to leave heavy loads on the weighing pan for longer periods of time.
6. In case of damage, immediately unplug the balance from the mains.
7. Balance to be decommissioned must be decommissioned in accordance with valid legal regulations.
8. Do not use the balance in areas endangered with explosion. The balance is not intended to be operated in hazardous areas.

### 1.5. Warranty Conditions

- A. RADWAG feels obliged to repair or exchange all elements that appear to be faulty by production or by construction.
- B. Defining defects of unclear origin and means of their elimination can only be realised with assistance of the manufacturer and user representatives.
- C. RADWAG does not bear any responsibility for damage or loss resulting from unauthorized or inadequate performing of production or service processes.
- D. The warranty does not cover:
  - mechanical damage caused by product exploitation other than intended, damage of thermal and chemical origin, and damage caused by lightning, overvoltage in the power grid or other random event,
  - damage caused by product exploitation other than intended,
  - damage, when security seal stickers protecting balance housing against unauthorized access are removed or broken,
  - damage caused by liquids, water and natural wear,
  - damage caused by inappropriate setting or by electrical system failures,
  - damage caused by overloading of the mechanical measuring system,
  - inappropriate cleaning habits.
- E. Loss of warranty takes place if:
  - a repair is carried out outside RADWAG authorized service point,
  - service claims intrusion into mechanical or electronic construction by unauthorized people,
  - other than original version of the operating system is installed in a balance,
  - the balance does not feature security stickers.
- F. For detailed warranty conditions read the service card.

## **1.6. Supervision Over Metrological Parameters**

Metrological parameters need to be checked in determined time intervals. Inspection frequency depends on ambient conditions in which the balance is operated, type of carried out processes and adopted quality management system.

## **1.7. User Manual Significance**

Even if you are experienced and have already worked with this type of balance, you are still obliged to read this user manual carefully prior switching the device on. This user manual provides information guaranteeing fault-free balance operation. As long as you follow the guidelines your balance operation is correct and reliable.

## **1.8. Training**

The balance must be operated and supervised only by personnel who have been trained to use such type of a weighing instrument.

## **2. TRANSPORT AND STORAGE**

### **2.1. Delivery Check**

Upon delivery it is necessary to check the package and the device, make sure that your package bears no signs of damage. Otherwise contact the manufacturer's representative.

### **2.2. Packaging**

Keep all package elements should your device be transported in the future. Remember that only original packaging can be used for shipping purposes. Prior packing, uncouple any cables, remove any separable components (weighing pan, shields, inserts). The balance components must be packed into an original packaging, this is to protect them against potential damage during transportation.

## **3. UNPACKING AND INSTALLATION**

### **3.1. Workstation**

- Operate the device in a workroom free of vibrations and shakes, where there are no air drafts nor dust.
- Permissible ambient temperature range: + 10 °C ÷ + 40 °C.
- Make sure that the relative humidity is not higher than 80%.
- Make sure that in the course of balance operation the room temperature changes slowly and gradually.
- Place the balance either on a robust-design table or on a wall bracket which is both distant from heat sources and unsusceptible to vibrations.
- Take special precaution while weighing magnetic objects, part of the balance is a strong magnet. Should magnetic loads be weighed, use under-pan weighing option in order to remove the weighed load from an area influenced by the magnet. The hook for under-pan weighing is installed in the balance base. Shall static electricity affect balance indications, it is necessary to ground the base, grounding bolt is placed at the back.

### **3.2. Unpacking**

Cut the adhesive tape. Take the device out of the packaging. Open the accessory box, take the balance components out of it.

### 3.3. Standard Delivery Components List

- Balance
- Bottom weighing chamber shield (XA)
- Centring ring (XA)
- Weighing chamber shield/lid (UYA, MYA)
- Weighing pan
- Weighing pan shield
- Bottom ring (MYA, model B and C)
- Power supply
- User manual - CD version

#### UYA 4Y MYA 4Y Microbalances

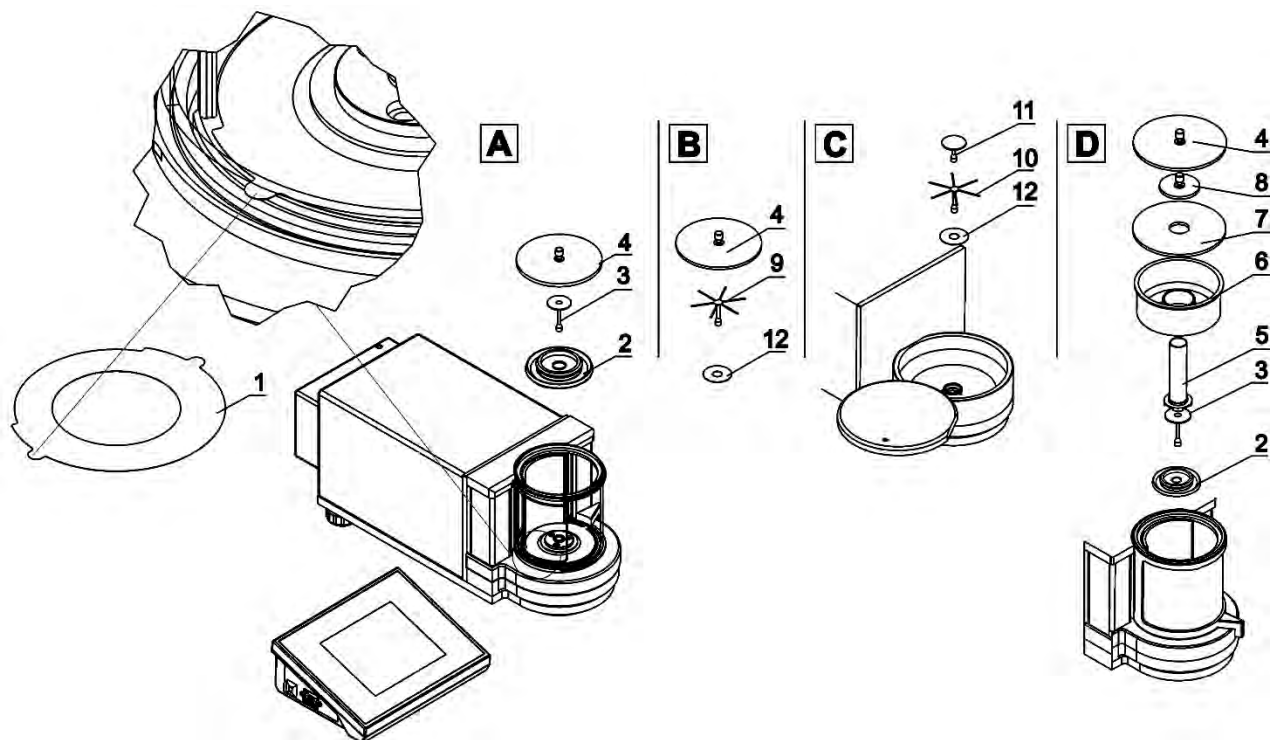

**Caution!** Make sure there is no protective sticker 1 while carrying out the measurement (see the above diagram). It is obligatory to remove the sticker prior chamber assembly.

Install components following the above diagram.

A

Standard UYA and MYA balance:

- Anti-draft shield (2)
- Weighing pan (3)
- Glass lid for the weighing chamber (4)

B

MYA 0.8/3.4Y microbalance (equipped with standard weighing pan and weighing pan for filters):

- Bottom ring (12)
- Weighing pan for filters (9)
- Glass lid for the weighing chamber (4)

C

Balance for filters:

- Bottom ring (12)
- Weighing pan for filters (10)
- Standard weighing pan (11)

D

Balance for pipettes calibration:

- Anti-draft shield (2)
- Weighing pan (3)
- Glass vessel (4)
- Evaporation ring (5)
- Glass lid with an opening (6)
- Additional glass lid (7)
- Glass lid for the weighing chamber (4)



Pipette calibration:

Run the balance, replace the weighing pan with a set of a weighing pan and a glass vessel (5).  
When the indication is stable press TARE button.

### MYB 4Y Microbalances

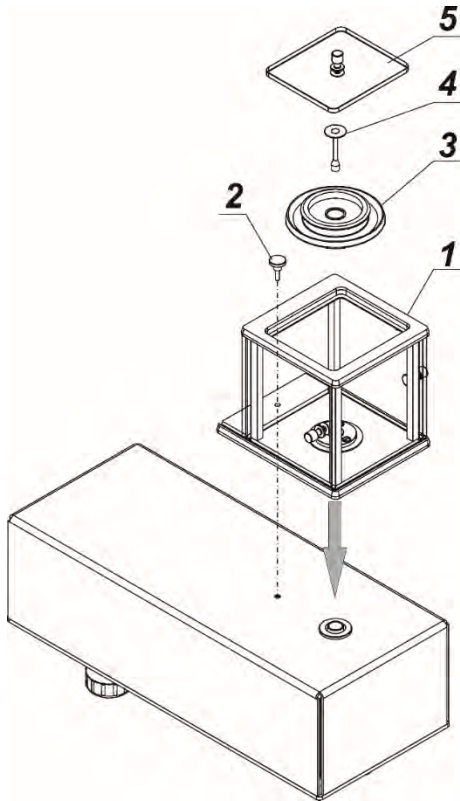

Take all the components from the packaging.  
Install the anti-draft chamber (1) and screw it to the base using bolt (2).

Install:

- draft shield (3),
- weighing pan (4),
- glass lid (5).

### XA 4Y.M.A Microbalances

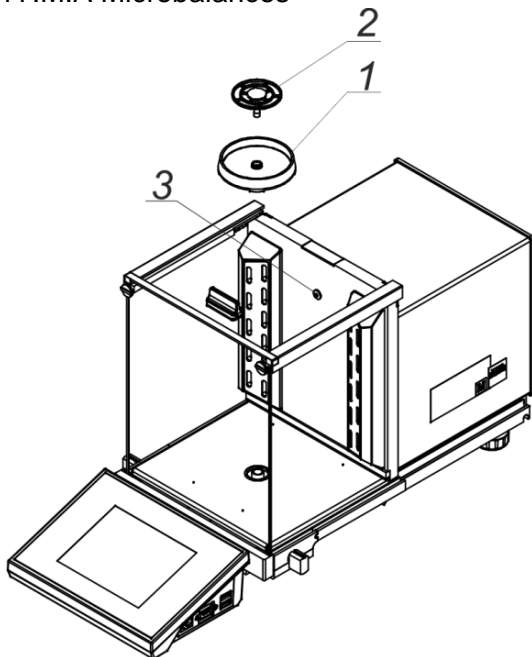

Install:

- draft shield (1),
- weighing pan (2).

3 - diode: ionizer on/off

## XA 4Y.M Microbalances

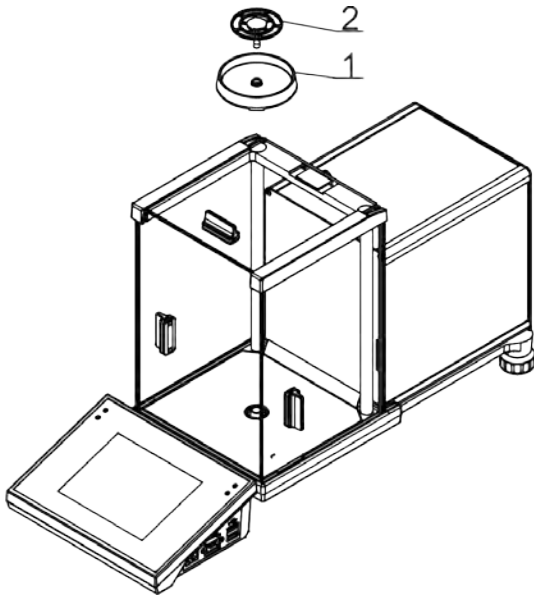

Install:  
 - draft shield (1),  
 - weighing pan (2).

## XA 4Y Series Balances

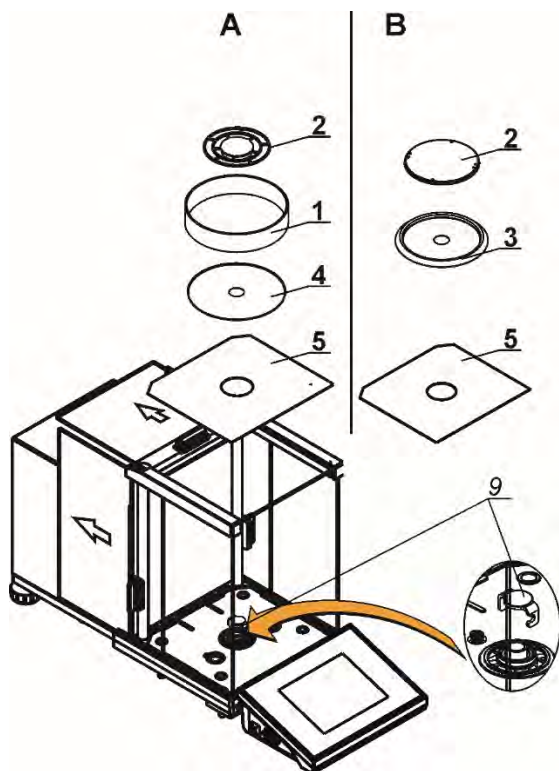

A – balance with  $d = 0.01$  mg  
 B – balance with  $d = 0.1$  mg

Remove the transport lock (9): press the transport lock down gently, turn it in direction pointed by <OPEN> arrow, remove the protection. Keep the transport lock to ensure proper protection of the weighing instrument during transportation.

Install:  
 - bottom weighing chamber shield (5),  
 - centring ring {embossing side upwards} (4),  
 - weighing pan (2),  
 - draft shield (3) or (1).

### Balance for pipettes calibration

Replace the draft shield and the weighing pan with chamber for pipettes calibration, inside install:

- weighing pan,  
 - other components (see description below).

## XA 4Y.A Series Balances

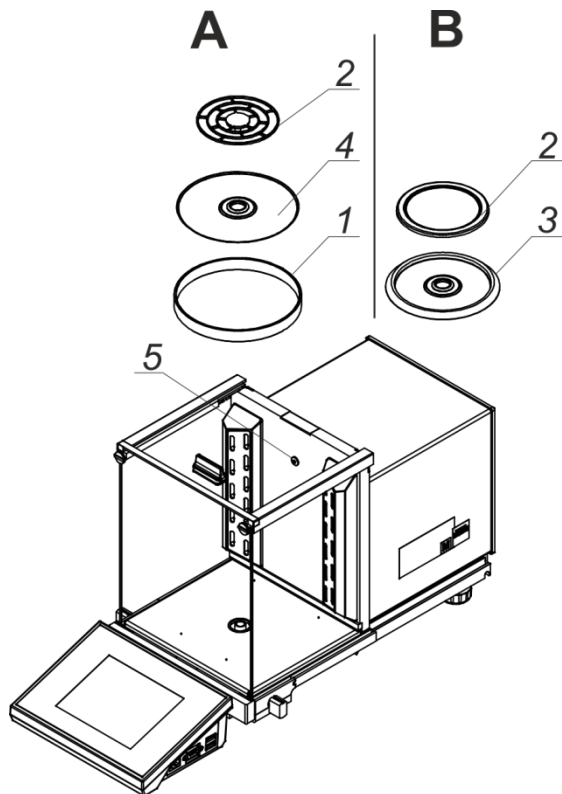

A – balance with  $d = 0.01 \text{ mg}$

B – balance with  $d = 0.1 \text{ mg}$

Remove the transport lock - gently press down the transport lock and turn it in accordance with <OPEN> arrow, then remove the protecting element. Keep the transport lock to ensure proper protection of the weighing instrument during transportation.

Install the components, follow the diagram.

Install:

- centring ring {embossing side upwards} (4),
- weighing pan (2),
- draft shield (3) or (1).

5 - diode: ionizer on/off

### Balance for pipettes calibration

Replace the draft shield and the weighing pan with

chamber for pipettes calibration, inside install:

- weighing pan,
- and other components (see description below).

## XA 4Y.F Series Balances

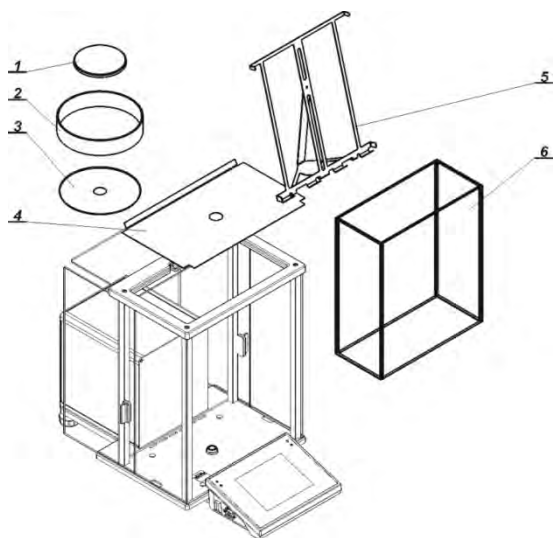

Install all standard components:

- bottom weighing chamber shield (4),
- bottom ring (3),
- standard weighing pan (1),
- draft shield (2).

Install additional accessories.

Connect the balance to the mains, to do it use power supply that comes standard with the balance.

Prior filters weighing remove draft shield (2), standard weighing pan (1), and bottom shield (3). Next open the weighing chamber, inside place a glass shield (6), install a pan - stand intended for weighing of the filters (5).

Tare balance indication.

Start weighing.

**Caution!** Be careful while uninstalling the components so as not to cause any damages to the balance mechanism.

### 3.4. Maintenance Activities

**Caution!** *Cleaning the weighing pan while still installed may cause damage of the measuring system.*

1. Uninstall the weighing pan and other detachable components (the components differ depending on a balance type – see section: *UNPACKING AND INSTALLATION*). Be careful while uninstalling the components so as not to cause any damages to the balance mechanism. In case of microbalance it is recommended to take the weighing pan out using tweezers.
2. Using handheld vacuum cleaner remove dust from the weighing chamber (recommended for the microbalance).
3. In order to ease cleaning of some of the weighing instrument components, it is permissible to remove them following the below instruction.

#### **Cleaning Draft Shield Panes**

Select dissolvent depending on a dirt. Never soak the glass panes in alkaline solutions since they interact with glass and may cause damage. Do not use cleansers containing abrasive substances.

For organic dirt use acetone first, next use water or detergent. For other than organic dirt use diluted acid solutions (soluble salts of hydrochloric or nitric acid) or base solutions (ammonium or sodium base).

To remove ACIDS use protophilic solvent (sodium carbonate), to remove BASE use protogenic solvent (mineral acid of various concentration).

In case of heavy contamination use brush and detergent, nevertheless avoid detergents containing large and hard molecules which could potentially scratch glass panes.

At the end of the cleaning process rinse the pane using distilled water.

Use soft brush with wooden or plastic handle exclusively in order to avoid risk of scratches. Do not use wire brush.

Rinsing is a necessary cleaning process stage allowing to remove remaining soap, detergents and other cleansers from the panes prior their reinstallation.

After preliminary cleaning process stage, rinse the pane using running water first, distilled next.

Avoid drying the panes either using paper towel or forced air circulation since some fibres, grains or contamination of other type could permeate into the panes thus causing weighing errors.

We do not recommend using driers when drying measuring glass tools.

It is a frequent treatment to leave glass components on a rack to dry.

#### **Cleaning Powder-Coated Components**

For preliminary cleaning process stage you need running water or wet sponge featuring large holes, this will help you to remove loose, heavy dirt.

Do not use cleansers containing abrasive substances.

Next, using cloth and cleanser-water solution (soap, dishwashing liquid) gently rub the cleaned surface.

Avoid using cleanser without water since it may result with damage of the cleaned surface, please mind that large amount of water mixed with cleanser is a must.

#### **Cleaning Aluminium Components**

While cleaning aluminium components use products acid by nature, e.g. spirit vinegar, lemon. Do not use cleansers containing abrasive substances. Avoid using hard brush, this may cause scratches. It is recommended to use microfibre cloth.

While polishing the surface use circular movements. Use clean, dry cloth to make the surface shine.

### Cleaning Stainless Steel Components

Avoid using cleansers containing any corrosive chemicals, e.g. bleach (including chlorine). Do not use cleansers containing abrasive substances. Always remove the dirt using microfibre cloth to avoid damage of protective coating.

In case of a daily maintenance:

1. Remove the dirt using cloth dipped in warm water.
2. For best results, add a little bit of dishwashing detergent.

### Cleaning ABS Components

To clean dry surfaces and avoid smudging, use clean non-colouring cloths made of cellulose or cotton. You can use a solution of water and detergent (soap, dishwashing detergent, glass cleaner). Gently rub the cleaned surface and let it dry. Repeat the cleaning process if needed.

In the case of hard to remove contamination, e.g.: residues of adhesive, rubber, resin, polyurethane foam etc., you can use a special cleaning agents based on a mixture of aliphatic hydrocarbons that do not dissolve plastics. Before using the cleanser for all surfaces we recommend carrying out tests. Do not use cleansers containing abrasive substances.

Disassembly steps:

#### MYA Series Balance

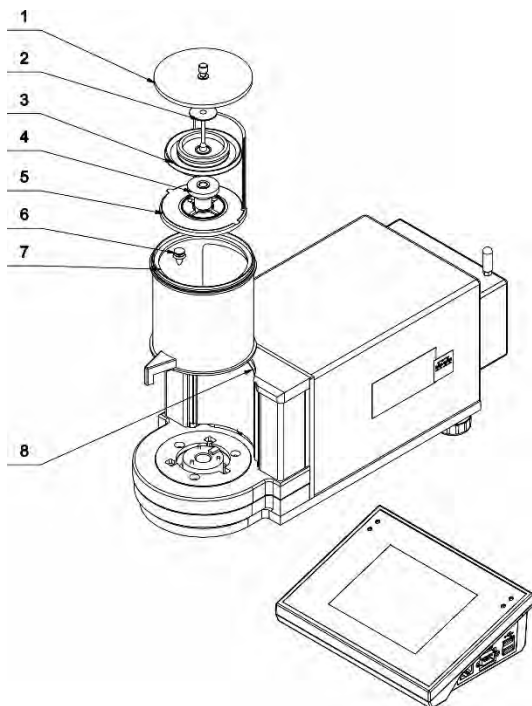

- Open the chamber.
- Carefully remove the weighing pan (2).
- Remove the draft shield (3).
- Undo draft shield sleeve (4).
- Remove internal ring assembly (5).
- Remove snap-in holder (6), lever it using e.g. tweezers.
- Close the chamber, press the clamp (8) down and move the ring assembly (7) to the front and up.

Disassembly steps:

MYA F Series Balance	
	<ul style="list-style-type: none"> <li>• Open and remove chamber lid (1).</li> <li>• Remove the weighing pan (2).</li> <li>• Press the buttons marked with arrows to release the chamber for filters weighing (3) and remove it.</li> </ul> <p><i>Caution: Pay special attention while assembling the chamber. Guide the pins so that they are evenly inserted into the base openings (inaccurate inserting of the pins will cause incorrect assembly and may cause balance damage).</i></p>

XA 4YA Series Balance

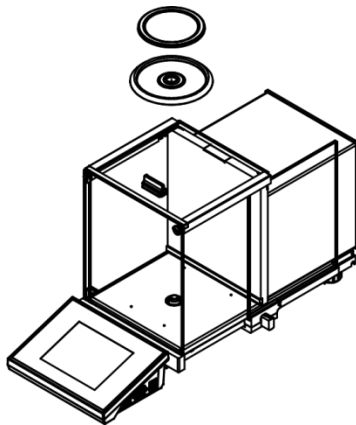

Remove the weighing pan and draft shield. Clean the components when detached. With this your balance mechanism is protected against accidental damage.

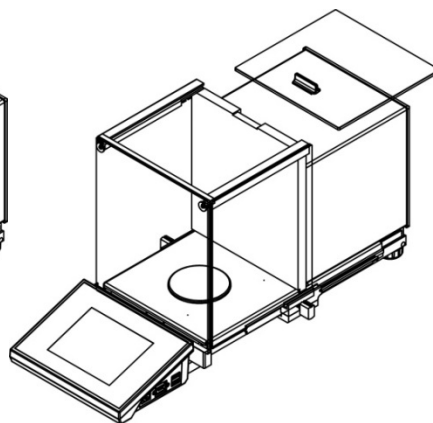
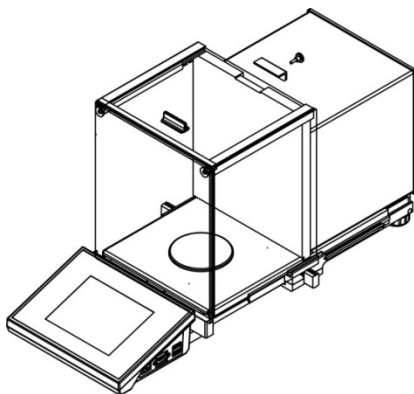

Undo and remove top pane protection, next slide the pane out of a guide bar.

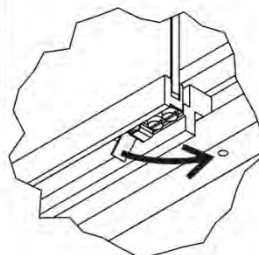
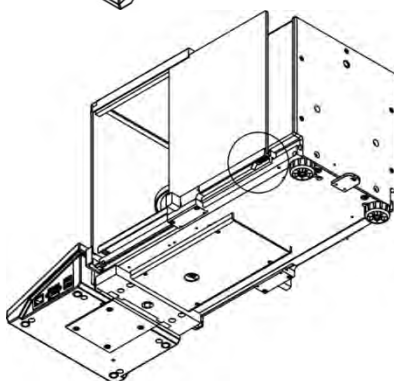

Remove the left and the right side pane. Before removing the panes completely, pull protection, see the picture on the left. The side panes are not interchangeable therefore it must be remembered which is left, which is right. Upon cleaning procedure completion, the panes must be installed on the correct side.

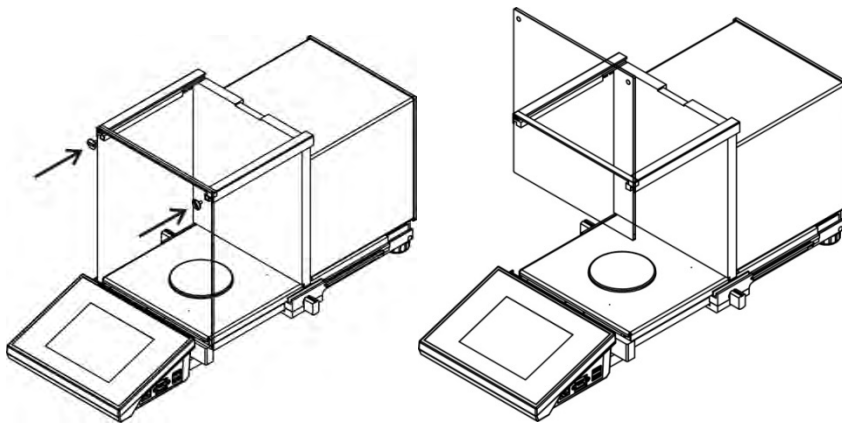

Undo the screws protecting the front pane, next remove it.

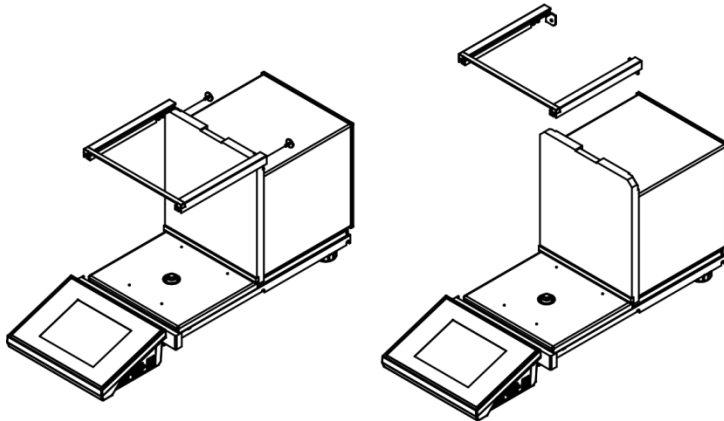

Undo the screws protecting the top frame, next remove it.

#### XA 4Y Series Balance

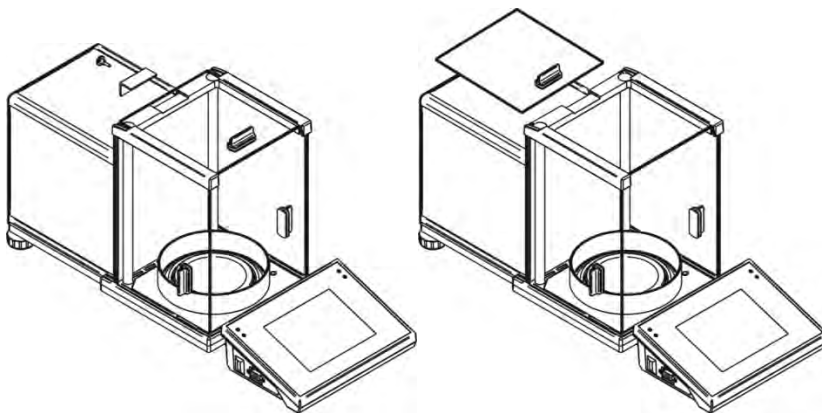

Undo and remove top pane protection, next slide the pane out of a guide bar.

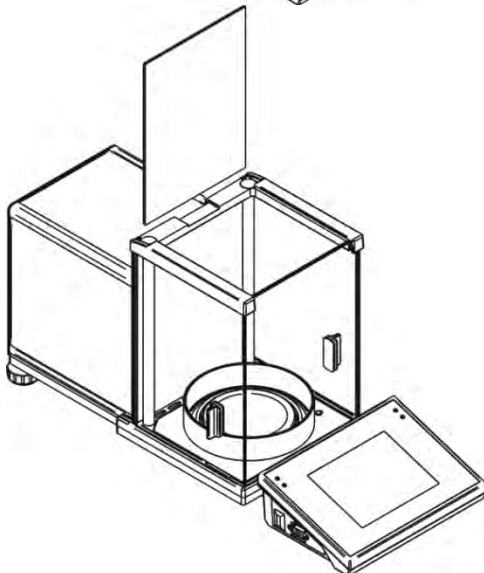

Remove the back pane.

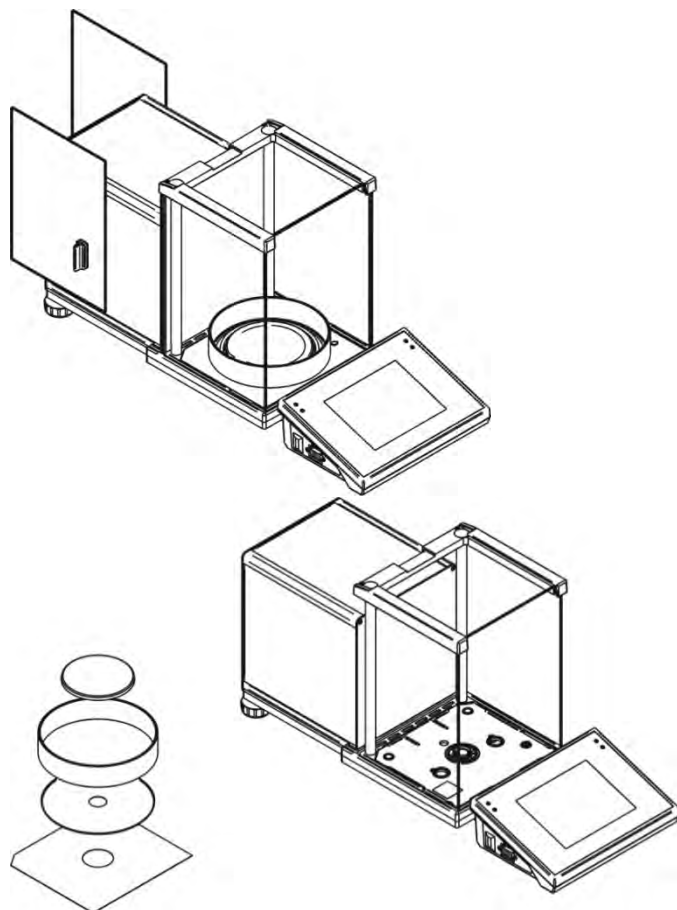

Remove the left and the right side pane. The side panes are not interchangeable therefore it must be remembered which is left, which is right. Upon cleaning procedure completion, the panes must be installed on the correct side.

Caution: Do not remove the front panel!

Remove the weighing pan, draft shields and bottom plates. Clean the components when detached. With this your balance mechanism is protected against accidental damage.

Thus prepared anti-draft chamber and panes can be properly cleaned. All the operations have to be done carefully. Pay special attention to the spot where the weighing pan is installed; dirt and other small elements might enter the balance construction through this opening. This might influence balance operation negatively. Upon completion of the cleaning process assembly the balance, take actions like before but in a reverse order. Pay a special attention to the left and the right side panes, assembly them on the correct side of the balance. While sliding the pane back onto its place remember to pull the protection (like before when disassembling the anti-draft chamber).

### 3.5. Connecting the Balance to the Mains

The balance must be connected to the mains using a power supply that comes standard with the particular model. Nominal voltage of the power supply (specified on the power supply data plate) has to be compatible with the mains nominal voltage.

Plug the balance to the mains – connect the power supply to the socket, next connect its connector to interface located at the back of the balance housing.

### 3.6. Temperature Stabilization Time

Before start of the measuring processes, it is necessary to wait until the balance reaches thermal stabilisation.

Balances stored in much lower temperatures, than the workroom temperature, before being plugged to the mains must be subjected to thermal stabilisation. The thermal stabilisation period takes about 12 hours. During the thermal stabilization, the indications on the screen can change. Potential workroom temperature change shall occur gradually and slowly in the course of the weighing instrument operation.

### 3.7. Connecting Peripheral Equipment

Use only accessories and peripheral equipment recommended by the manufacturer. The balance must be disconnected from the mains before connecting or disconnecting any peripherals (printer,



PC computer, computer keyboard of USB type, additional display). Upon connecting the peripherals, plug the balance to the mains.

### 3.8. Balances with Wireless 'Indicator'-'Module' Connection

*(optional design)*



The indicator operates on batteries; it cooperates with the weighing module via an internal wireless connection module (in contrast to a standard design, no cable connecting the devices is required). Wireless connection solution is marked by letter B, e.g. XA 220.4Y.B.

#### **Features:**

Maximum range: 10 m.

Maximum battery operating time: 8 h.

#### **Advantages:**

1. **Elimination of additional sources of vibration**

Indicator located elsewhere than the weighing table eliminates vibrations being a result of indicator operation. This ensures stable working conditions for balances with the highest resolution. No specific weighing workstations are needed.

2. **Comfort of weighing in fume cupboards and laminar flow cabinets**

Wireless connection between an indicator and a weighing module positively influences the weighing process making it more comfortable and safer.

3. **Safety while weighing toxic substances**

Due to wireless connection the weighing module can be completely separated from the operator by being placed in an anti-draft chamber. This makes weighing of contaminated and toxic substances possible without putting one's health and life to risk.

4. **Improved pipetting ergonomics**

Pipettes calibration process requires such skills that guarantee precise and fast operation. Wireless connection adds to ease of use and guarantees high measurement.

This balance model is equipped with two power supplies. One used to power the weighing module, the other to charge indicator.

#### **3.8.1. Start-Up**

Unpack the balance, install it at the workplace, connect the weighing module and the indicator to the mains. Next proceed like in case of a standard design (description to be found further down this user manual).

Home screen for wireless connection solution

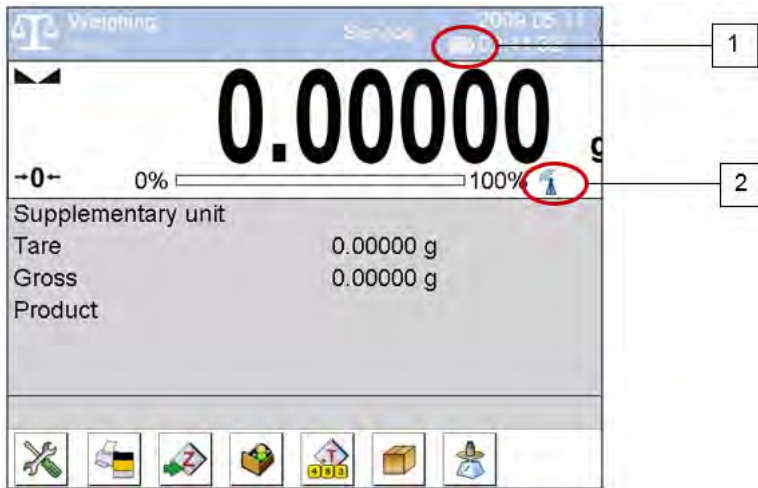

Home screen for wireless connection solution features two extra pictograms:

1. Battery charge status,
2. Wireless connection.

Operation and functions are identical like for standard design balances.

### 3.8.2. Wireless Connection Pictograms

Battery status

No.	Pictogram	Description
1		Battery charge in progress.
2		Fully-charged battery, indicator connected to the mains.
3		Fully-charged battery, indicator disconnected from the mains.
4		Half-charged battery, indicator disconnected from the mains.
5		Battery about to be discharged, connect the indicator to the mains.

Wireless connection

No.	Pictogram	Description
1		Connection between wireless modules established correctly – correct cooperation.
2		No connection between wireless modules established.

### 3.8.3. Settings



In order to provide long enough operation while powering the device by means of battery, go to Misc. function group and set <Sleep mode> and <Display brightness> parameters respectively. For detailed information read section 34 of this user manual: *Miscellaneous Parameters*).

### 3.9. Balances with a Built-In Ioniser

The antistatic ionizer, an in-built component of XA 4Y.M.A microbalance and XA.4Y.A balance, neutralizes electric charges inside the weighing chamber upon placing the sample in it. The lower the value of relative humidity and a reading unit of the balance, the more evident influence of static electricity. The ionizer neutralizes uncompensated electric charge accumulated on weighed object. Affected operation as a results gives greater repeatability error, often also greater error of indication. Measurement errors, due to the harmful effects of electrostatics, often reach the value of thousands of reading units and more. The problem concerns non-conductive samples, e.g. glass flasks, paper filters, plastics, etc.



Implemented in the XA 4Y.M.A.I microbalance antistatic ionizer is a modern technology solution which compensates both cations and anions. The ionizer activates when the microbalance door opens, and deactivates when the door is closed.

It is possible to control ionizer using quick access button.

	Press to swap between activate and deactivate state.
	Press to activate.
	Press to deactivate.

The operation is signalled by blue LED diode (installed at the back of the weighing chamber) which emits light when the ionizer is on.







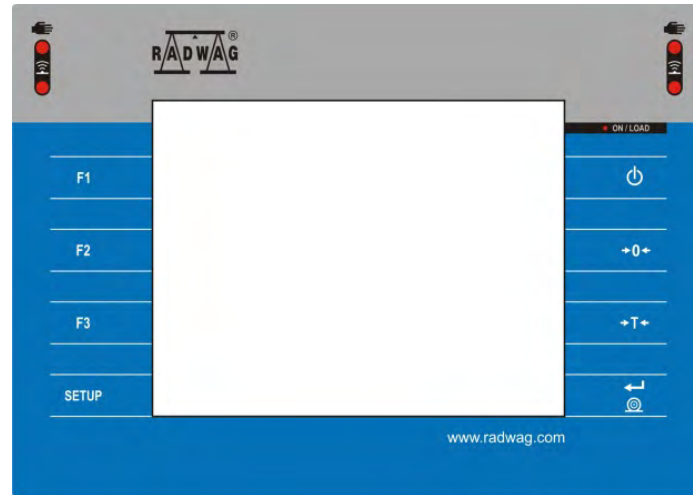

#### 4. START-UP

1. Connect the power supply to the mains, ON/LOAD  diode on the operation panel lights up.
2. Press  key, the system and RADWAG program are loaded which is signalled with blinking of red ON/LOAD diode.
3. Upon completed start-up, the home screen is displayed automatically.
4. The balance runs with no user logged in. In order to start operation it is necessary to log in (for detailed logging procedure read later sections of this user manual).

**Caution:** Before you start the balance, make sure that there is no load on the weighing pan.

## 5. OPERATION PANEL















Key	Description
	Press to switch the balance ON/OFF.
	Press to zero the balance.
	Press to tare the balance.
	Press to send the weighing result to a printer or a computer.
	Press to enter the menu.
	Press to select working mode; programmable key.
	Press to select profile; programmable key.
	Press to carry out an internal adjustment; programmable key.

## 6. PROGRAM

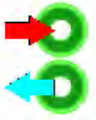
Program menu is divided into function groups. Function group is a group of interrelated parameters. For detailed description of each group, read later sections of this user manual.

### Menu - Function Groups

To access the main menu, press SETUP key or bottom bar button, . The menu comprises parameters related to balance settings, functions and profiles.

		
ADJUSTMENT	OPERATORS	PROFILES
		
DATABASES	COMMUNICATION	PERIPHERALS
		
INPUTS / OUTPUTS	ADMINISTRATOR PANEL	MISC.
		
AMBIENT CONDITIONS	UPDATE	ABOUT (system info)
		
VIDEOS		

## 7. WEIGHING RESULT WINDOW

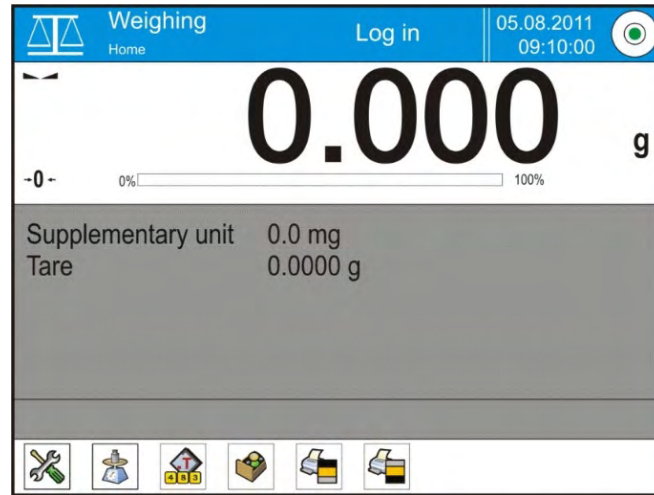

The home screen features 4 sections:

- Top section displaying data on active working mode, logged in user, date, time, computer connection status and level status.



- Section presenting the weighing result.

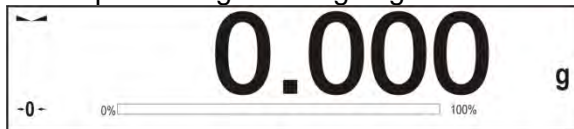

- Section comprising supplementary information on currently performed operations (grey background).

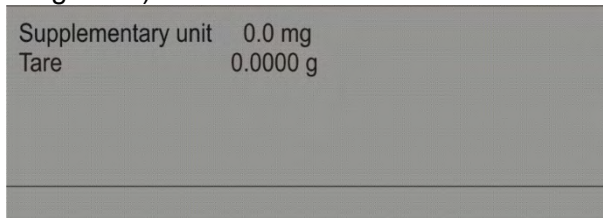

**Caution!** Data contained in this workspace is freely configurable. For detailed information on data configuration read section 14.4 of this user manual.

- Section comprising on-screen function buttons:



**Caution!** The operator can define the on-screen function buttons. For detailed information read section 14.3 of this user manual.

## 8. LOG IN OPERATION

In order to access operator-related parameters and in order to edit databases, you need to log in as an operator with **<Administrator>** permissions level.

### First Log In:

1. Go to home screen, press **<Log in>** entry, wait for the operators database window with **<Admin>** entry to open.
2. Press **<Admin>** entry, wait for the on-screen keyboard with a password box to open.
3. Enter „1111” password and press  button to confirm.
4. Home screen is displayed, **<Log in>** entry is replaced with **<Admin>** name.
5. When logged, add operators and set the permissions levels, for detailed procedure read section: 11 and 12).

While logging in again, select an operator from the list and enter the password, the program initiates operation with permissions level set for the selected operator.









### Log Out:









1. Go to home screen, press logged in operator name, wait for the operators database to open.
2. Press **<Log out>** entry (1st position on the operators list).
3. Home screen is displayed, admin name is replaced with **<Log in>** entry.

## 9. OPERATING THE MENU

Operation of program menu is intuitive. The touch panel makes the operation easy. By pressing an on-screen button or any field, you activate respective function/operation.

### 9.1. Navigation



 or 	Press to enter the main menu.
	Press to scroll the menu up.
	Press to scroll the menu down.
	Press to scroll the menu 'up-down' fast
	Press to confirm the introduced modifications.
	Press to exit, parameter remains unmodified.
	Press to add database record.
	Press to search particular database entry by date.

	Press to search particular database entry by name.
	Press to search particular database entry by code.
	Press to print database entries.
	Press to clear edit box content.
	Press to switch the on-screen keyboard on/off.
	Press to read printout template saved to *.lb file (the button becomes active upon connecting the USB flash drive).
	Press to select printout template variables out of the list.
	Press to go one menu level up.

## 9.2. Return to the Weighing Mode

Modifications introduced into balance memory, are automatically saved upon return to weighing operation.

### Procedure:

1. Press  button repeatedly, keep pressing until you see the home screen.
2. Press  button (top bar), the home screen is displayed immediately.

## 10. ADJUSTMENT

4Y series balances feature automatic internal adjustment system which ensures correct measurement accuracy. Menu <ADJUSTMENT> contains functions controlling operation of balance adjustment process.

### 10.1. Internal Adjustment

Internal adjustment is carried out by means of an internal adjustment weight. <Internal adjustment> button, when pressed, automatically triggers adjustment process. Upon adjustment process completion respective message, informing about process end and about its status, is displayed.

**Caution!** Balance adjustment procedure requires stable conditions (no air drafts, no vibrations), in the course of adjustment the weighing pan must be unloaded.







## 10.2. External Adjustment

External adjustment is carried out using an external mass standard of the right accuracy and weight value, which value depends on balance model and capacity. The external adjustment procedure is a semi-automatic process, particular stages of which are signalled with on-screen prompts.

**Caution!** External adjustment is possible for balances that are not a subject to the conformity assessment (verification).

### Procedure:

1. Enter <Adjustment> submenu, next select  External adjustment> parameter.
2. Message ordering you to remove weight is displayed. Unload the weighing pan and press  button. The balance determines start mass, message: Start mass determination is displayed.
3. Upon completed start mass determination, message ordering you to load the weighing pan is displayed. Load the pan with weight of respective mass value, and press  button.
4. Upon completed procedure unload the weighing pan, press  button to confirm, the balance returns to the weighing mode.

## 10.3. User Adjustment

User adjustment can be carried out using any adjustment weight, mass of which ranges between 0.15 Max and Max. User adjustment and external adjustment procedures are likewise with one exception, before user adjustment start, an edit box for entering mass of the used adjustment weight is opened.

**Caution!** User adjustment is available for balances that are not a subject to the conformity assessment (verification).

In order to start user adjustment, enter <Adjustment> submenu and select  User adjustment> option. Then follow commands displayed on the screen.

## 10.4. Adjustment Test

<Adjustment test> function enables comparing the result of an internal automatic adjustment with the value recorded in balance factory parameters. The comparison is used for determining drift of balance sensitivity over time.

## 10.5. Automatic Adjustment

Enter this menu to specify conditions initiating an automatic adjustment. Options:

- None – automatic adjustment inactive.
- Time – adjustment takes place in time intervals declared in <Automatic adjustment time> menu (10.6).
- Temperature – adjustment is triggered by temperature change.
- Both – adjustment is triggered by both, temperature changes and time.

**Caution!** This parameter settings can be modified only for balances that are not a subject to the conformity assessment (verification).

## 10.6. Automatic Adjustment Time

 Automatic adjustment time> parameter determines time interval between successive automatic internal adjustments. The time interval is declared in hours and ranges between 1 and 12 hours.

To set time interval for automatic adjustment:

- enter <Automatic adjustment time> parameter,

- using displayed menu, select appropriate time interval (given in hours) which is to elapse between the most recent adjustment and activation of the following automatic internal adjustment.

**Caution!** This parameter settings can be modified only for balances that are not a subject to the conformity assessment (verification).

## 10.7. Scheduled Adjustments

<  Scheduled adjustments > parameter allows you to precisely specify time for adjustment performance and interval between successive adjustments. The parameter is not connected with automatic adjustment and its criteria (time, temperature). You can schedule when internal and external adjustment are to be performed. In order to design schedule for external adjustment, it is necessary to record mass standards for adjustment performance into balance memory.

### Procedure:

1. Enter data of mass standards intended for external adjustment performance; to do it:
2. Enter operator menu, select <Adjustment> submenu and find <  Adjustment weights > parameter.

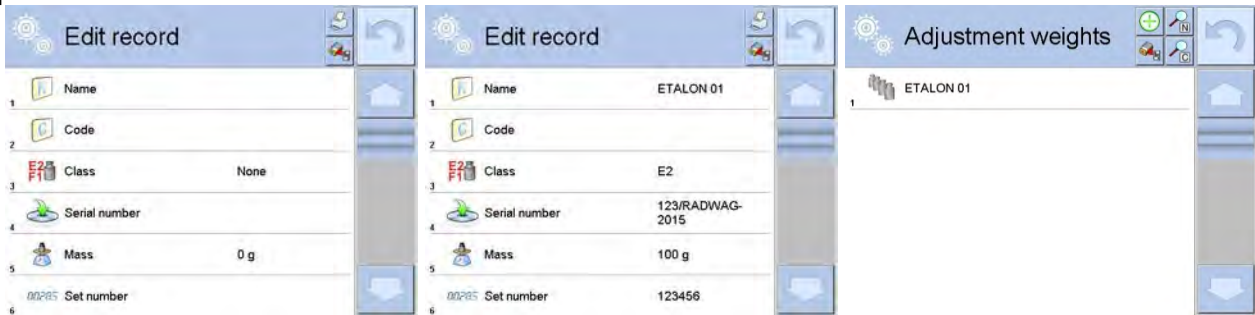

<p>The screenshot shows the 'Adjustment' menu with the following items: Adjustment test, Scheduled calibrations, Adjustment weights (highlighted), Report printout (Yes), GLP project, and Adjustment history.</p>	<p>Enter operator menu, select &lt;Adjustment&gt; submenu and find &lt;Scheduled adjustments&gt; parameter.</p>
<p>The screenshot shows the 'Scheduled adjustments' window, which is currently empty.</p>	<p>Enter &lt;Scheduled adjustments&gt; parameter, wait for 'Scheduled adjustments' window to open, add adjustment procedures. Remember, only Administrator can add new entries.</p>

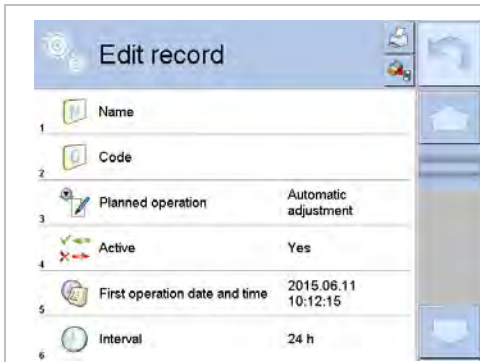

In order to add a new position, press  button, wait for a window with data on scheduled adjustment to open.



Select task: automatic adjustment (internal or external).



For automatic adjustment option, enter data on the adjustment and its schedule.



For external adjustment option, enter data on the adjustment, mass standard used for the adjustment performance and its schedule.

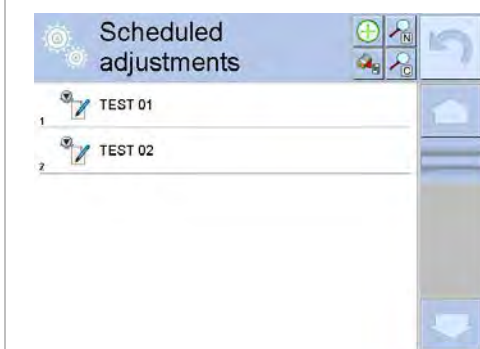

When all necessary data has been introduced, return to the previous window. The window features newly added entry.

Upon entering all data exit the menu.

Now all the adjustments are carried out automatically as scheduled and with specified time intervals.

## 10.8. Report Printout



<  Report printout > parameter determines whether or not an adjustment report is to be automatically printed upon adjustment process completion.

In order to set automatic report printout, go to <  Report printout > parameter and select <YES> value.

## 10.9. GLP Project

GLP is one of many methods for documenting work in accordance with adopted quality system. Data selected for printing is printed on each release of an adjustment report.

Information and signs to be used in a GLP report:

- adjustment (adjustment type)
- working mode (working mode name)
- date, time
- user
- balance model
- Balance S/N
- level status
- nominal mass
- current mass
- difference
- temperature
- empty line
- dashes
- signature
- non-standard printout

## 10.10. Adjustment History

Adjustment history contains data on all carried out adjustment processes. The record is carried out automatically. Each adjustment record comprises basic data on completed process. This menu enables displaying the list of completed adjustment processes. Each report is printable.

In order to print an adjustment report, enter <Adjustment> submenu, next enter <Adjustment history> parameter, select adjustment to be printed. Record details are displayed, press  print button.

**Caution!** *If the balance memory is full then the oldest record gets automatically deleted.*

If internal procedures of an organization require maintaining complete documentation concerning all carried out adjustment processes, then the list with adjustment records has to be printed and archived periodically.

### Searching for adjustment record

It is possible to search for a specific completed adjustment record. To do that, press  search button and enter date of an adjustment process that is to be found.

### Exporting data on completed adjustment process

Connect a USB flash drive to balance USB port. Press <Data export> button, it is located on the top of the display. The process is fully automatic and on its completion a file with **.db** extension is saved to a USB flash drive connected to the USB port.

## 11. OPERATORS

Operators database features list of users permitted to operate the balance. The following data can be defined for each balance operator:

- Name
- Code
- Password
- Name and surname
- Permissions
- Account active
- Language
- Default profile
- Card no.

Operator can be added by the Administrator exclusively. In order to add an operator:

1. Enter <Operators> menu, press <Add>  button.
2. Define all necessary data.

**Caution!** It is possible to search for an operator in a database of operators by code or name.

In order to edit an operator:

1. Press field with operator name.
2. Data on a specific operator is displayed.
3. Select and change necessary data.

Operators can be deleted by the Administrator exclusively.

In order to delete an operator:

1. Press and hold operator name.
2. Menu referring to a user record is displayed.
3. Select <Delete> parameter.

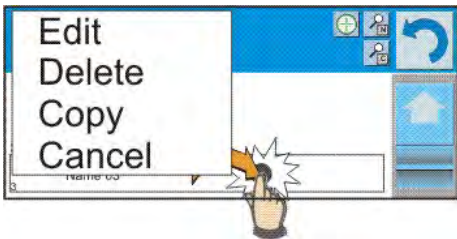

## 12. ADMINISTRATOR PANEL

 Administrator submenu is designed to set scope of operations for particular users assigned with given permissions, password protection level, and unlogged operator permissions.

**Caution!** This menu can be modified only by an operator with administrator permissions level.

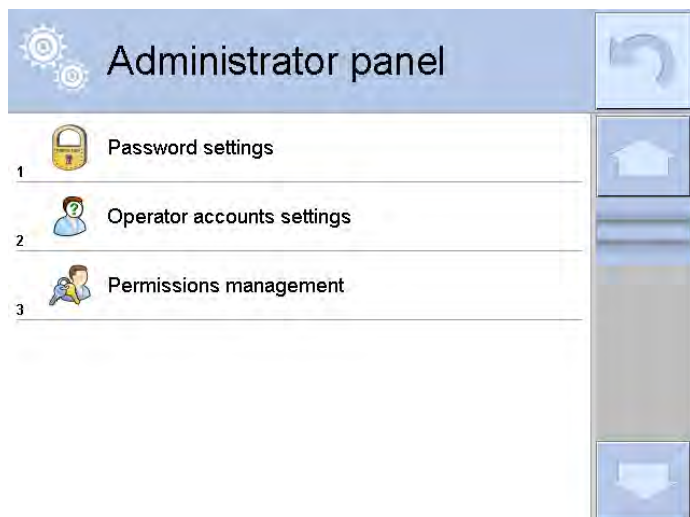

## 12.1. Password Settings

This submenu is designed to set password sophistication rate.

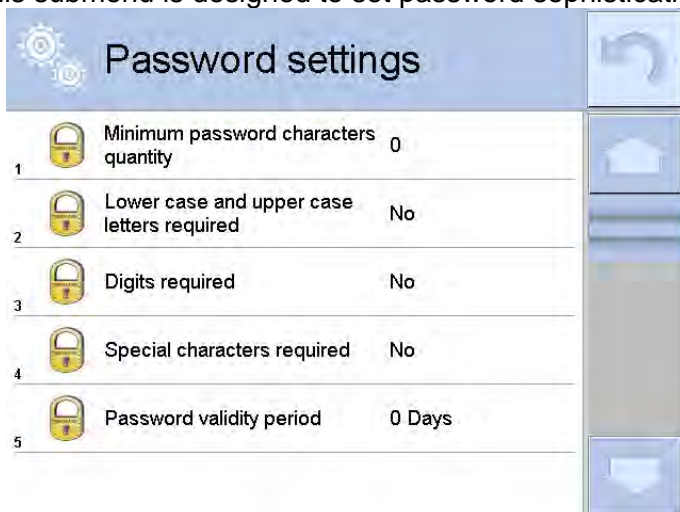

<b>Minimum password characters quantity</b>	Parameter for specifying minimum quantity of characters to be used in a password. „0” - set to enable password consisting of freely selected number of characters.
<b>Lower case and upper case letters required</b>	Parameters specifying requirements regarding password characters type and format.
<b>Digits required</b>	
<b>Special characters required</b>	
<b>Password validity period</b>	Setting time interval after passage of which the password expires. „0” - set to disable password request.



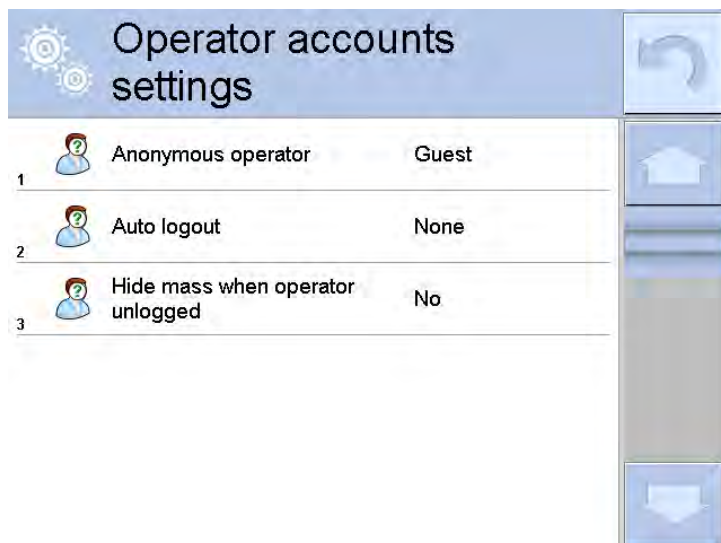

## 12.2. Operator Account Settings



### Unlogged operator permissions

Administrator can assign an unlogged balance operator (so called anonymous operator) with permissions level.

#### Procedure:



1. Enter < Permissions> submenu.
2. Select < Anonymous operator> parameter.
3. Set respective permissions: Guest, Operator, Advanced operator, Administrator.

**Caution!** Operator assigned with <Guest> permissions level is not allowed to modify program settings.

### Auto logout

With Auto logout function on, the operator is logged out automatically if the balance is not operated within a specified time interval, given in minutes. By default the function is off (<None> value set).

#### Procedure:

1. Enter < Permissions> submenu.
2. Select < Auto logout> parameter.
3. Set respective value: none/3/5/15/30/60. Time given in [min].

## 12.3. Permissions Management

### Databases

Permissions management			Database		
1	 Database		1	 Databases preview	Operator
2	 Date and time	Operator	2	 Products	Administrator
3	 Printouts	Administrator	3	 Customers	Administrator
4	 Header printout	Operator	4	 Formulations	Administrator
5	 Footer printout	Operator	5	 Packaging	Administrator
6	 Printout / Enter key	Operator	6	 Warehouses	Administrator

Default balance settings enable operator who is logged as **Administrator** to modify settings of particular databases. The software allows Administrator to change permissions level, and as a result authorize other operators to modify settings of databases.

Procedure:



1. Enter < Administrator panel> submenu.
2. Select <Databases> parameter.
3. Set respective permissions for particular databases: Guest, Operator, Advanced operator, Administrator.

**Caution!** When <Guest> option is set, <Database> parameter is freely accessed (there is no need to log in).

### Date and Time

Default balance settings enable operator who is logged as Administrator to modify date and time parameter. The software allows to change permissions level, and as a result authorize other operators to access < Date and time> parameter.

Procedure:



1. Enter < Permissions> submenu.
2. Select < Date and time> parameter.
3. Set respective permissions: Guest, Operator, Advanced operator, Administrator.

**Caution!** When <Guest> option is set, <Date and time> parameter is freely accessed (there is no need to log in).

### Printouts

Default balance settings enable operator who is logged as Administrator to edit printouts. The software allows to change permissions level, and as a result authorize other operators to access < Printouts> parameter.

Procedure:

1. Enter < Permissions> submenu.
2. Select < Printouts> parameter.
3. Set respective permissions: Guest, Operator, Advanced operator, Administrator.





**Caution!** When <Guest> option is set, <Printouts> parameter is freely accessed (there is no need to log in).

### Value release

Default balance settings enable operator who is logged as User to edit printout templates. The software allows Administrator to change permissions level and as a result authorize other operators to access < Value release> parameter.

Procedure:



1. Enter < Permissions> submenu.
2. Select < Value release> parameter.
3. Set respective permissions: Guest, Operator, Advanced operator, Administrator.

**Caution!** When <Guest> option is set, <Value release> parameter is freely accessed (there is no need to log in).

### Videos

Default balance settings enable operator who is logged as Administrator to modify <Videos> submenu (add, delete files). The software allows Administrator to change permissions level, and as a result authorize other operators to access < Videos> parameter.

Procedure:

1. Enter < Permissions> submenu.
2. Select < Videos> parameter.
3. Set respective permissions: Guest, Operator, Advanced operator, Administrator.

**Caution!** When <Guest> option is set, <Videos> submenu is freely accessed (there is no need to log in).

## 13. PROFILES

A Profile is a data pack that determines:

- particular function operation, e.g. 'Parts counting', 'Percent weighing', etc.,
- data to be displayed during operation,
- function keys that are to be active,
- measuring units that are to be accessible,
- criteria determining speed of operation and measurement stability.

Balance software allows you to create numerous profiles, this enables:

- designing an individual working environment by each operator,
- customized balance operation, i.e. activating selected function keys and information (improved operation performance).

For ease of operation, 4 default balance profiles have been designed. The profiles settings provide optimal weighing process for particular requirements and conditions.

Profile names:

- **Fast** – profile set to enable fast measurement of mass of any size regardless of the selected working mode. Fast profile gets activated automatically at the first balance start-up. For Fast profile, the parameters settings enable obtaining the final result as fast as possible.
- **Fast dosing** – profile intended for dosing, it is set to enable fast dispensing of product. For this profile selected, the DOSING mode gets activated automatically,

- **Precision** – profile set to enable precise measurement of mass of any size regardless of the selected working mode. For this profile the weighing process takes a lot of time, but this guarantees the most precise weighing result.
- **User** – basic profile, filters settings provide quite fast and precise measurement. For this profile selected, the WEIGHING mode gets activated automatically.

**Caution!** You can modify all settings of User profile. Settings of other profiles (Fast, Fast dosing and Precision) can be modified only to a limited extend. It is possible to create additional profiles. Additional profiles settings can be fully modified.

### 13.1. Creating a Profile

Default profile is named <Home>. The Administrator can create new profiles by:

- copying an already existing profile and modifying it,
- adding a new profile.



#### Copying an existing profile

Procedure:

1. Enter the main menu, to do it press **Setup** key.
2. Enter <Profiles> submenu.
3. Press and hold profile that is to be copied.
4. Menu referring to a profile record is displayed. Select <Copy> parameter.
5. A new <Name copy> profile is created, new profile settings and base profile settings are identical.
6. Modify necessary data: (name, etc.).

#### Adding a new profile

Procedure:

1. Enter main menu, to do it press **Setup** key.
2. Enter <Profiles> submenu.
3. Press  button, message <Create new record?> is displayed.
4. Press  button to confirm. The software automatically adds a new record, the new record edit box opens.

#### Deleting a profile

Procedure:

1. Enter the main menu, to do it press **Setup** key.
2. Enter <Profiles> submenu.
3. Press and hold profile that is to be deleted.
4. Menu referring to a profile record is displayed. Select <Delete> parameter.
5. Message box: <Delete?> is displayed.
6. Press  button to confirm, the profile gets deleted.

**Caution!** In order to operate profiles it is necessary to log in as an Administrator.



### 13.2. Profile Structure

Profile parameters list:

<b>Settings</b>	Enter this menu to set an individual profile name (alphanumeric characters string), and to declare a default working mode (the selected mode is run as default upon profile activation).
<b>Working modes</b>	Mode submenus: <ul style="list-style-type: none"> <li>• Additional settings of a working mode</li> <li>• Buttons</li> <li>• Information</li> </ul>

	<ul style="list-style-type: none"> <li>• Printouts</li> </ul>
<b>Readout</b>	Readout submenus: <ul style="list-style-type: none"> <li>• Filter</li> <li>• Value release</li> <li>• Autozero</li> <li>• Autozero: Dosing</li> <li>• Last digit</li> </ul>
<b>Units</b>	Enter this menu to declare start unit, supplementary unit, 2 custom units and to enter the value of gravitational acceleration force of the place of use.

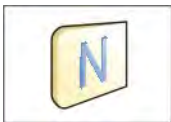
### 13.2.1. Settings

	<p><b>Name</b></p> <p>Upon entering this parameter, a message box with an on-screen keyboard is displayed. Enter the name of a profile and press  button to confirm. The name is assigned to the profile.</p>
	<p><b>Default working mode</b></p> <p>Upon entering this parameter you can select a specific working mode that is to be set as default. For &lt;None&gt; value set, upon selecting the profile, the balance activates the most recently used working mode.</p>

### 13.2.2. Working Modes

Upon entering Working Modes parameter, a window containing all accessible working modes is displayed. Parameters are set for each working mode independently. Particular profile when activated runs with given set of parameters.

List of parameters common for each working mode:





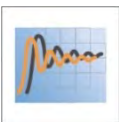

- Settings: specific parameters relating to a working mode, and universal settings such as: result control, tare mode, automatic footer printout, printout mode, printout.
- Functions of quick access buttons: declaring quick access buttons to be displayed.
- Information: declaring information to be displayed.
- Printouts: declaring type of a printout or defining a non-standard printout.

### 13.2.3. Readout

You can adjust the balance to ambient conditions (filter level) or to your own needs.

List of <Readout> menu parameters:

	<p><b>Filter</b> (disabled for Fast, Fast dosing, Precision profiles)</p>
	<p>Each measurement signal before being displayed is electronically processed in order to provide correct parameters specific for stable measurement result ( ready to be read). You can determine signal processing rate, there are five different filters to select from:</p> <ul style="list-style-type: none"> <li>• very fast,</li> <li>• fast,</li> <li>• average,</li> <li>• slow,</li> <li>• very slow.</li> </ul>

	<p>While setting the filter consider the actual operating conditions. In case of very good operating conditions select average or fast filter, in case of rough conditions select slow or very slow filter.</p> <p><b>Caution!</b> For precision balances it is recommended to select very fast, fast or average filter. For analytical balances and microbalances it is recommended to select average, slow, or very slow filter.</p>
	<p><b>Value release</b> (disabled for Fast, Fast dosing, Precision profiles)</p>
	<p>The parameter has been designed to determine when the stability marker is to be displayed.</p> <p>There are three different settings:</p> <ul style="list-style-type: none"> <li>• fast,</li> <li>• fast and reliable,</li> <li>• reliable.</li> </ul> <p><b>Caution!</b> Both parameters, filter and value release, determine how long it takes to obtain stable result.</p>
	<p><b>Autozero Function</b></p>
	<p>The function has been designed to enable automatic control and correction of zero indication.</p> <p>If the function is enabled, the subsequent measurement results are compared to each other in constant time intervals. If the results differ less than declared Autozero range, e.g. 1 division, the balance is automatically zeroed, and the pictograms of stable indication, , and precise zero, , are displayed. Active Autozero function means, that each measurement starts with the precise zero. There are, however, some cases when this function can be a disturbing factor for the measuring process, e.g. very slow placing of a load on the weighing pan (load adding, e.g. pouring, filling). In such case, the system correcting zero indication may also correct the actual indication of a load placed on the weighing pan.</p> <p>Values:</p> <p><b>NO</b> - autozero function disabled.</p> <p><b>YES</b> - autozero function enabled.</p>
	<p><b>Autozero function: Dosing</b> (disabled for Fast, Fast dosing, Precision profiles)</p>
	<p>The function has been designed to enable/disable autozero function for Dosing.</p> <p>Values:</p> <p><b>NO</b> - autozero function disabled automatically when Dosing mode is run.</p> <p><b>YES</b> - autozero function enabled automatically when Dosing mode is run.</p>
	<p><b>Last digit</b></p>

	<p>The function has been designed to enable/disable visibility of the last decimal place of measurement result.</p> <p>Values:</p> <p><b>Always:</b> all digits are displayed.</p> <p><b>Never:</b> last digit disabled.</p> <p><b>When stable:</b> last digit displayed only when the result is stable.</p>
	<b>Ambient Conditions</b>
	<p>Parameter relating to ambient and environmental conditions of the workstation.</p> <p>For unstable ambient conditions it is advisable to set the parameter to 'Unstable' value.</p> <p>By default the parameter is set to 'Stable' value.</p> <p>'Stable' value results with faster operation, i.e. weighing takes much less time than in case of 'Unstable' value set.</p>

#### 13.2.4. Units

For a selected profile you can declare start unit, supplementary unit and two custom units.

A custom measuring unit features:





- a multiplier,
- a name (3 characters).







Upon completed operation of designing a custom unit, its name is added to the list of accessible measuring units.

Units menu enables you to enter the value of gravitational acceleration force characteristic for a place of use. It is obligatory should the balance be used to determine mass in [N].

#### 14. WORKING MODES – General Information

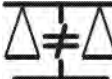
4Y series balances feature the following working modes:

	<b>Weighing</b>		<b>Parts Counting</b>
<p>Means of operation: weight of a load is determined through an indirect measurement. The balance measures gravitational force which attracts the load. The obtained result is processed and displayed on the balance screen in a digital format.</p>		<p>Means of operation: based on a weight value of a single piece it is possible to count pieces quantity; necessary conditions: the weight value of a single piece is determined with sufficient accuracy, the mass of all the pieces is the same.</p>	
	<b>Checkweighing</b>		<b>Dosing</b>
<p>Means of operation: control of sample's mass carried out with reference to specified thresholds, it is necessary to give the value of min threshold &lt;LO&gt; and max threshold &lt;HI&gt;.</p>		<p>Means of operation: it is necessary to specify sample's target mass to be obtained by dispensing (pouring, filling, etc.).</p>	

 <b>Percent weighing</b>	 <b>Density</b>
<p>Means of operation: control of percent ratio of a test sample in relation to a reference sample. Obtained data provides info on how much the test sample differs from the adopted reference sample.</p>	<p>Means of operation: the balance, based on Archimedes principle, determines density of solids and liquids. The mode requires use of an optional density determination kit.</p>
 <b>Animal weighing</b>	 <b>Formulations</b>
<p>Means of operation: mass measurement carried out with use of filters which dampen animal moves on a weighing pan, the filters enable to obtain a correct measurement result.</p>	<p>Means of operation: by mixing number of ingredients you can obtain particular mixture, in order to program given formulation it is necessary to give mass values for particular ingredients.</p>
 <b>Statistics</b>	 <b>Pipettes Calibration</b>
<p>Means of operation: carried out measurements are used to calculate statistical data such as Min, Max, deviation, etc.</p>	<p>Means of operation: calibration of pipettes in accordance with ISO 8655 standard procedure or with regard to user requirements.</p>
 <b>Differential weighing</b>	 <b>Statistical quality control</b>
<p>Means of operation: analysis of change of sample mass over time.</p>	<p>SQC is a mode useful in the course of packing process, it aims to monitor and/or control product packing. It enables detecting product deficiency and excess.</p>
 <b>Peak hold</b>	 <b>Mass Control</b>
<p>Means of operation: freeze of max weight value on a display (max. indication reflecting the greatest force exerted on a pan).</p>	<p>Fast statistical control of samples in accordance with requirements of quality systems and/or internally adopted standards. <i>(function disabled for standard balance models)</i></p>
 <b>Pre-packaged Goods Control</b>	
<p>Control of pre-packaged goods in accordance with regulation on <i>Pre-packaged goods</i>. <i>(function disabled for standard balance models)</i></p>	

Particular working modes feature specific settings. The settings enable adapting mode operation to your individual needs. The specific settings are activated upon selecting a respective profile. For detailed description of specific working mode settings refer to the given working mode section.



## 14.1. Running Working Mode

To run working mode other than currently operated one:

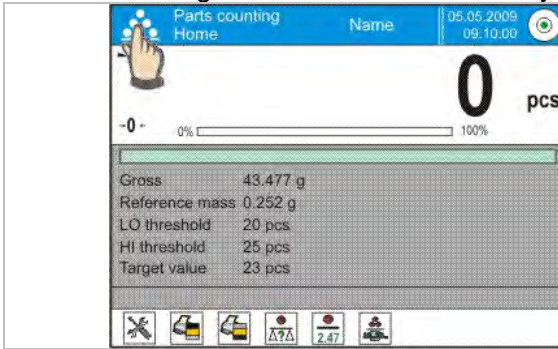

1. Press active working mode name.
2. List of all working modes is displayed.
3. Select the mode that is to be operated.

## 14.2. Working Mode Parameters

Each working mode has programmable parameters determining its functioning. To access particular working mode parameters:

1. Press grey workspace area.
2. The following menu is displayed:
  - <Settings> - additional options.
  - <Buttons> - quick access buttons configuration.
  - <Information> - setting data that is to be displayed in the workspace.
  - <Printouts> - setting printout type and content.
  - <Profile> - setting profile that is to be used during operation.

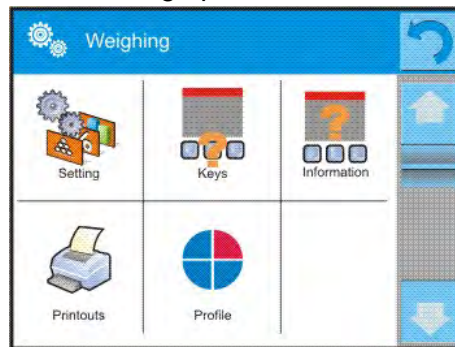
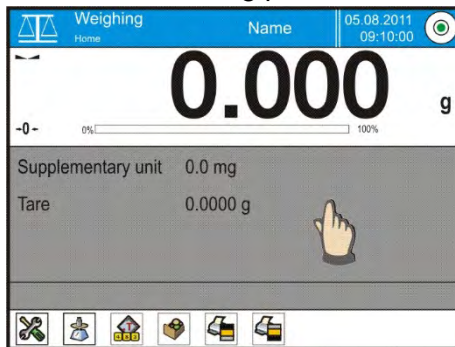

3. Enter particular submenu and select the component that is to be modified.

Description of basic parameters of <Settings> menu is to be found in section 15.7, *Additional Parameters of the Weighing Mode*. For detailed information on all but basic parameters of particular working modes read given working mode section.

## 14.3. Quick Access Buttons, Proximity Sensors

You can define up to 7 quick access buttons, which are to be displayed in the bottom bar.

Upon assigning a button with a function, respective pictogram is displayed in a bottom bar of the home screen.

Each working mode features customized set of buttons. For complete buttons list read Annex B.

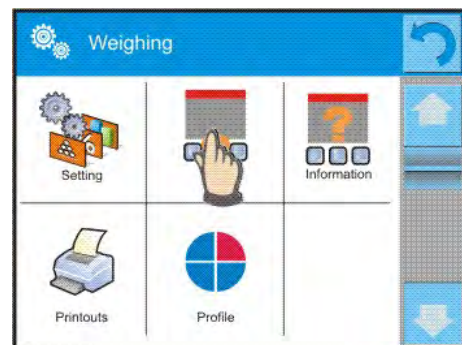

**Caution!** You can view user manual saved to balance memory. In order to take advantage of this



function add Help button to a tool bar,

### 14.3.1. Proximity Sensors

The balance is equipped with two proximity sensors which enable touch free control.

The program detects four motions:

1. Hand in a close vicinity to the left sensor <**Left proximity sensor**>.
2. Hand in a close vicinity to the right sensor <**Right proximity sensor**>.
3. Hand motion to the left (move your hand over both sensors, from the right sensor to the left sensor) <**Proximity sensor: gesture to the left**>.
4. Hand motion to the right (move your hand over both sensors, from the left sensor to the right sensor) <**Proximity sensor: gesture to the right**>.

**Caution!** Using 'Gesture to the left' option, and 'Gesture to the right' option, requires the <Proximity sensor timeout> parameter to be set to **500 ms** value!

List of operations to be assigned: None; Profile; Adjustment; Zero; Tare; Set tare; Disable tare; Enable tare; Packaging; Print; Header printout; Footer printout; Unit; Universal variable 1; Universal variable 2; Universal variable 3; Universal variable 4; Universal variable 5; Accept; Abort; Operator; Left door; Right door; Open/close door; Parameters; Product; Warehouse; Customer.

Upon completed configuration procedure, the software runs function assigned to a particular proximity sensor, having detected motion around it. To provide correct operation, it is necessary to set respective proximity sensors sensitivity and delay (read section 34, 'Proximity sensors sensitivity').

### 14.3.2. Automatically Opened Door

Settings for devices equipped with auto door opening and closing mechanism, MYA 4Y and XA 4Y.A series balances. The settings concern quick access buttons and proximity sensors.

MYA 4Y series balance:

- **Open/close door** – parameter for changing door state; e.g. door closing when the weighing chamber is opened, and door opening when the weighing chamber is closed.
- **Left door** – changing position (open/close state) of door on the left side of the weighing chamber.
- **Right door** – changing position (open/close state) of door on the right side of the weighing chamber.

XA 4Y.A series balance:

- **Open** – weighing chamber door opening.
- **Close** – weighing chamber door closing.
- **Open/close door** – parameter for changing door state; e.g. door closing when the weighing chamber is opened, and door opening when the weighing chamber is closed.

To swap from manual to automatic door opening mode in XA 4Y.A balance:

1. Turn the door knob 180o either left or right.
2. Using your hands slide the door, both left and right, to the front and back, due to this the door couple with the mechanism.

Door coupling is easy to be sensed (the pawls get engaged with the notch). To return to manual operation, turn the knob to its previous position.



## 14.4. Information

Information related to the weighing process is displayed in the grey workspace. The workspace can contain up to six data. Mind that if you select more than six data, only the first six of them is displayed. Each data features two values:

- YES – data enabled,
- NO – data disabled.

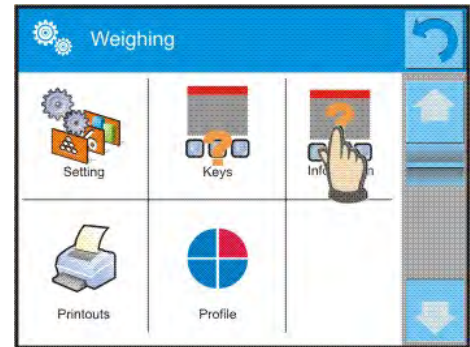

## 14.5. Printouts

Printout menu comprises two separate sections: standard printouts, and non-standard printouts.

### Standard printout

Standard printout comprises three internal sections containing different variables. YES value - variable printout enabled, NO value - variable printout disabled.

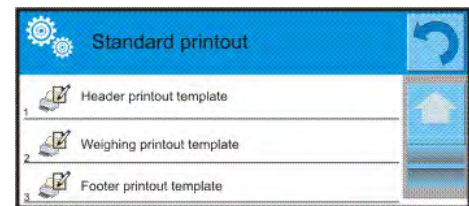

### Procedure:

1. Press name of a selected template (Header – GLP Printout – Footer) and select variables that are to be printed.
2. In case of non-standard printout, create it.

HEADER	GLP PRINTOUT	FOOTER
<ul style="list-style-type: none"> <li>• Dashes</li> <li>• Working mode</li> <li>• Date</li> <li>• Time</li> <li>• Balance type</li> <li>• Balance S/N</li> <li>• Operator</li> <li>• Level status</li> <li>• Customer</li> <li>• Warehouse</li> <li>• Product</li> <li>• Packaging</li> <li>• Universal variable 1 ... 5</li> <li>• Empty line</li> <li>• GLP report</li> <li>• Non-standard printout</li> </ul>	<ul style="list-style-type: none"> <li>• N (measurements quantity)</li> <li>• Date</li> <li>• Time</li> <li>• Level status</li> <li>• Customer</li> <li>• Warehouse</li> <li>• Product</li> <li>• Packaging</li> <li>• Universal variable 1 ... 5</li> <li>• Net</li> <li>• Tare</li> <li>• Gross</li> <li>• Current result</li> <li>• Supplementary unit</li> <li>• Mass</li> <li>• Non-standard printout</li> </ul>	<ul style="list-style-type: none"> <li>• Working mode</li> <li>• Date</li> <li>• Time</li> <li>• Balance type</li> <li>• Balance S/N</li> <li>• Operator</li> <li>• Level status</li> <li>• Customer</li> <li>• Warehouse</li> <li>• Product</li> <li>• Packaging</li> <li>• Universal variable 1 ... 5</li> <li>• Dashes</li> <li>• Empty line</li> <li>• GLP report</li> <li>• Signature</li> <li>• Non-standard printout</li> </ul>

## HOW TO OPERATE PRINTOUTS

1. In order to print variables of GLP PRINTOUT section, press PRINT button on the operation panel, only variables with YES attribute can be printed (see the above list).
2. Variables with YES attribute, present in the HEADER and FOOTER, are printed **ONLY** upon pressing **PRINT HEADER** and **PRINT FOOTER** pictograms. The pictograms have to be added to the bottom bar of the display as quick access buttons.

(For detailed instruction on how to add quick access buttons to the bottom bar of the display go to section 14.3)

	
Print header data	Print footer data

**Caution!** Measuring units for mass indication:

- Net – the main measuring unit (adjustment unit)
- Tare – the main measuring unit (adjustment unit)
- Gross – the main measuring unit (adjustment unit)
- Current result – currently displayed measuring unit
- Supplementary unit – supplementary measuring unit
- Mass – the main measuring unit (adjustment unit)

### Non-standard printout

Non-standard printout may contain TEXTS and VARIABLES (acquired from the software during printout). Each non-standard printout is a separate project, featuring specific name by which it is identified, and saved to the database of printouts.

#### Procedure:

1. Press <Non-standard printout> field.
2. Press < Add> button, window featuring Name/Code/Project data opens.
3. Set name and code of a printout.
4. Press <Project> button.
5. Printout edit box with an on-screen keyboard is displayed.
6. Use the keyboard to design printout template, the printout may contain texts and variables.

**Caution!** It is possible to add a printout by import of configured texts from flash drives connected to balance's USB port.

Printout's name is ONLY a NAME, and it is not part of its content.

For information on how to design a non-standard printout template read section 30.19 Printouts.

## 14.6. Profiles

Profiles function is described in section 13, *Profiles*.

## 15. WEIGHING

Load the weighing pan. Wait for a stable indication (display of stability marker, ) and read the measurement result.

Record/printout of the measurement result is available on pressing <PRINT> key:

- for verified balances – only stable measurement result is saved or printed (stability marker visible on balance's display),
- for non-verified balances – stable and unstable measurement results are saved or printed (regardless of stability marker absence). For unstable measurement result question mark <?> is printed next to the mass value.

### 15.1. Weighing Unit Selection

Change of weighing unit is carried out by pressing the weighing unit pictogram visible next to the value of measurement result. Upon pressing the weighing unit, list of available units is displayed. Select the unit you need, the software automatically recalculates indicated value.

Units list:

Unit	Symbol	Verified balance	Unit	Symbol	Verified balance
Gram	[g]	Yes	Taele Hongkong	[tlh]	No
Milligram	[mg]	Yes*	Taele Singapore	[tls]	No
Kilogram	[kg]	Yes*	Taele Taiwan	[tit]	No
Carat	[ct]	Yes*	Taele China	[tlc]	No
Pound	[lb]	No	Momme	[mom]	No
Ounce	[oz]	No	Grain	[gr]	No
Ounce Troy	[ozt]	No	Newton	[N]	No
Pennyweight	[dwt]	No	Tical	[ti]	No

\* - units accessibility is conditioned by the weighing instrument type.  
For non-verified weighing instruments all non-SI units are available.

## 15.2. Good Weighing Practice

To assure long-term operation and correct mass measurements, follow the rules presented below:

- Start the balance with no load on the weighing pan (permissible value of load on the weighing pan at start is  $\pm 10\%$  of the maximum capacity).
- Load the weighing pan steadily avoiding shocks.
- Go to <Setup/Misc./Vibrations Detection> parameter and enable control of weighing pan loading (for detailed information read section 34.8).

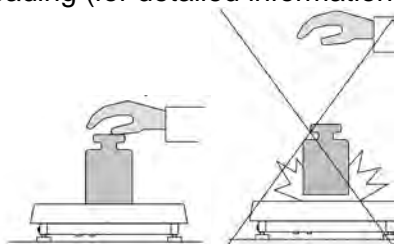

- Place weighed loads centrally on the weighing pan.

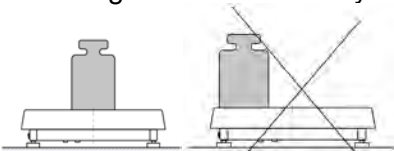

- Avoid side loading, in particular side shocks.

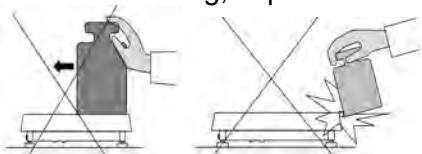

## 15.3. Levelling

The balance is equipped with an Auto Level System which allows monitoring of the balance level. Level monitoring is performed uninterruptedly in the course of balance operation. Level status is signalled with a respective pictogram, displayed in the upper right corner of the operation panel screen. The system monitors balance level state. In case of level deviation, position of level marker is displayed on the screen and/or respective alarm is activated. Balance level setting proceeds.

Procedure:

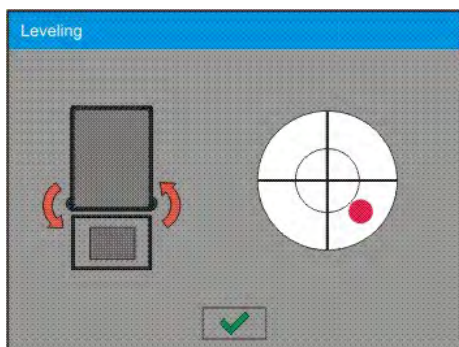

1. Press level status pictogram, , it is displayed in the upper right corner of the operation panel screen.
2. Control panel of level function is displayed. Along with the level indicator, balance view is presented.



3. Level the balance by turning its feet left/right, follow the blinking pictograms, <img alt="left arrow with red dot" data-bbox="740 215 765 235"/> <img alt="right arrow with red dot" data-bbox="740 235 765 255"/> – press to make level marker move toward the centre of the circle.
4. When the marker takes central position, its colour turns from red to green – the balance is correctly levelled.



**Caution!** The balance is equipped with Automatic Level Control mechanism. For detailed information regarding the mechanism operation refer to section 34.8 of this user manual.

### 15.4. Zeroing

To zero mass indication press  key. Zero indication and the following pictograms are displayed:  and . Zeroing operation means determining new zero point, recognized by the balance as precise zero. Zeroing is possible only when the indication is stable.

**Caution!** Indication can be zeroed only within  $\pm 2\%$  range of maximum capacity. If the zeroed value is above  $\pm 2\%$  of the maximum capacity, then the software indicates a respective Err2 error message.



### 15.5. Taring

To determine net weight value, load the weighing pan with a packaging, wait for a stable indication and press  key. Zero indication and the following pictograms are displayed: **Net** and . Upon unloading of the weighing pan, the sum of tared masses with minus sign is displayed. You can assign tare value to a particular product stored in the database. In such case the assigned tare value is automatically acquired upon selection of the given product.

**Caution!** It is impossible to tare negative values. When you try to tare negative values, the weighing instrument responds with an error message: **Err3**. In such case, zero the indication and repeat taring procedure.

### Entering Tare Value Manually

Procedure:

1. Press  quick access button. The button is available regardless of the working mode you operate.
2. An on-screen numeric keyboard is displayed.
3. Enter tare value and press  button.
4. Balance returns to weighing mode. Tare value with „-“ sign is displayed.

### Deleting tare

The tare value indicated on the display can be deleted by pressing  key on the operation panel, or by using programmable <Deactivate tare> function button.

**Procedure 1** - with tared load off the weighing pan:



1. press ZERO key,
2. the <Net> marker gets deleted, new zero point is determined.

**Procedure 2** - with tared load resting on the weighing pan:

1. press ZERO key,
2. the <Net> marker gets deleted, new zero point is determined;

3. when the tare value exceeds 2% of the maximum capacity, Err message is displayed in order to inform you about the fact that operation cannot be carried out.

**Procedure 3** - when the tared load is on the weighing pan or upon taking the tared load off the weighing pan:

1. press  Deactivate tare> programmable button,
2. the NET marker is deleted,
3. the display indicates tare value,
4. to restore the last tare value press  Restore tare> button.

### 15.6. Use of Air Buoyancy Compensation Factor

The application enables correcting mass measurement errors in the course of:

1. weighing loads of density considerably different from the density of standard that has been used to adjust the balance; typically the balance is adjusted with a steel mass standard of  $\sim 8.0\text{g/cm}^3$  density or a brass mass standard of  $\sim 8.7\text{g/cm}^3$  density; if loads made of other substances are weighed, then ratio indicated on below graph applies;

**Error value versus density of weighed sample**

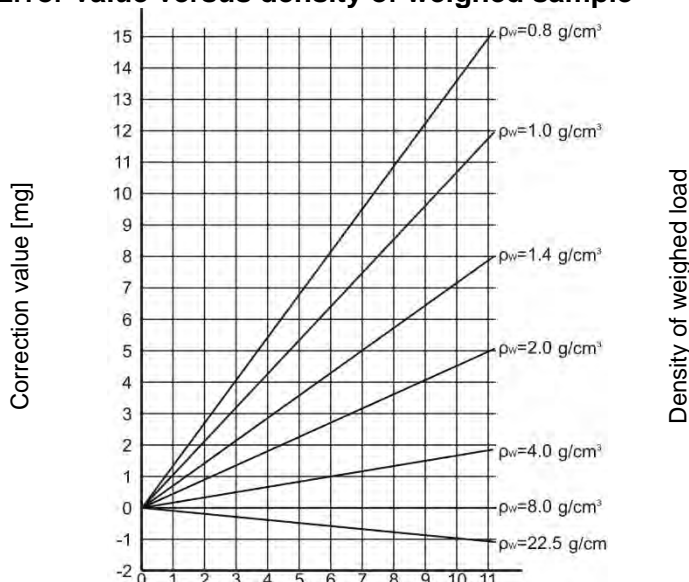

The graph presents correction values for versus the density of weighed load, assumption that air density is constant and equals  $1.2\text{ kg/m}^3$  is taken.

2. testing sample mass change within a few hours long period of time for a case when the sample mass is relatively constant (minor changes); it is assumed that air density changes affect the final result considerably, wherein the density is influenced by changes of pressure, temperature and humidity.

In order to carry out a reliable measurement it is necessary to know the measuring methods, features of tested sample, ambient conditions, air density in the laboratory room and density of weighed sample.

### Functioning

The air buoyancy compensation procedure is to be used as follows:

1. Method 1:
  - Enter air density value and value of weighed sample density to balance memory.
  - Wait, the software automatically calculates the correction factor for weighed mass, next corrected value of weighed mass is displayed.
  - In order to avoid mistakes, the corrected mass value is accompanied by  $\langle ! \rangle$  symbol, the symbol is visible on a display and a printout.
2. Method 2:
  - Determine air density value with use of balance program (semi-automatic operation) and enter value of weighed sample density to balance memory.
  - Determination of air density is carried out using a set of two mass standards, one made of stainless steel, and the other one of aluminium. Based on mass indications of the two standards,



the program automatically calculates the air density and saves the value in balance memory on operator's confirmation. Now, enter value of weighed sample density to balance memory. Wait, the software automatically calculates the correction factor for weighed mass, next corrected value of weighed mass is displayed. The corrected mass value is accompanied by <!> symbol, the symbol is visible on a display and a printout.

In order to enable/disable the air buoyancy compensation procedure go to the user menu. The procedure is valid for weighing mode exclusively.

### Air Buoyancy Compensation Start-Up

#### Procedure:

1. Enter home screen and press grey workspace.
2. Select <Settings> parameter.



3. Select <Air buoyancy compensation> parameter.

#### Settings:

- Air buoyancy compensation – YES/NO.
- Sample density (enter value of weighed sample density). If you use products from databases, then on product selection its density value is automatically uploaded.
- Air density – parameter designed to enable you to select the method of entering the air density value.

#### Parameter values:

**VALUE** – select to open a window where you enter specified air density value (e.g.: determined by means of other methods). The entered value is used in the course of compensation. It is assigned automatically upon completed air density determination (to complete air density determination press



< key).

**ONLINE** – select to make the balance acquire air density value from a connected THB sensor at a real time, if such is connected to the balance, or from internal sensor installed in the balance.

If your balance features both types of sensors (THB and internal), then data from the THB supersedes the other, in such case go to **Setup/Ambient conditions/Ambient conditions module** parameter and set **SAVE or SAVE & ALERTS** value.

If your balance features only one set of sensors recording temperature, humidity and pressure, then correct ONLINE operation requires setting the following parameters:

- internal sensors exclusively – go to **Setup/Ambient Conditions/Ambient conditions module** parameter and set NONE value,
- external THB sensor exclusively – go to **Setup/Ambient Conditions/Ambient conditions module** parameter and set SAVE or SAVE & ALERTS value.

For correct balance cooperation with the THB sensor it is necessary to set port's transmission parameters, they must be compatible with those of the THB sensor. The THB sensor transmission parameters are detailed on its data plate.

On returning to the weighing mode, the display indicates an additional symbol <!>, as indicated on the figure below. From now on the value of indicated mass is corrected, wherein the air buoyancy compensation factor and sample density are referred to.



The measurement result can only be compensated by a correct value if the operator enters the actual value of the air density and correct value of weighed sample density to balance memory.

**Caution!** If the <AIR BUOYANCY COMPENSATION> parameter is set to <ONLINE> value, then <!> pictogram is not displayed. This means that **Setup/Ambient Conditions/Ambient conditions module** parameter is set to SAVE or SAVE & ALERTS value, and that there is either no physical balance-module connection, or that balance-module communication parameters are incorrect. In such case plug the

module to balance ports COM 1 or COM 2 and set appropriate communication parameters, for the parameters refer to a data plate.

## 15.7. Additional Parameters for a Weighing Process

Modification of weighing functions enables programming balance operation.

### Procedure:

1. Press grey workspace area.
2. The following submenus are displayed: Settings, Buttons, Information, Printouts, Profile.
3. Enter particular submenu and select the component that is to be modified.

<Settings> - additional options related to weighing mode,

<Keys> - defining quick access buttons,

<Information> - supplementary data on weighing process displayed in an Info field,

<Printouts> - selecting printout type,

<Profile> - selecting profile that is to be active during balance operation,

<SETTINGS> - weighing process related data such as:

#### Tare mode

- SINGLE

Mass value saved to balance memory on single pressing of TARE key. Subsequent pressing of TARE key determines new tare value. Selecting product or packaging to which tare value is assigned causes automatic deleting of previously assigned tare value.

- CURRENT SUM

Total value of currently entered product and packaging tare values (result of selection of product and packaging from the database) with possibility to add tare value entered manually. When new tare value for a product or packaging is set again then tare value entered manually gets deactivated.

- TOTAL SUM

Total value of all entered tare values.

- AUTOTARE

#### Means of operation:

Each first stable measurement result is tared. NET sign is displayed. Now you can determine net mass of weighed load. Upon unloading the weighing pan and autozeroing, tare value is automatically deleted.

#### Automatic footer printout

- MODE

None – manual footer printout,

Sum of measurements – footer is printed when mass value entered in <Threshold> parameter gets exceeded.

Measurements quantity – footer is printed when a pre-defined measurements quantity (a batch) set in parameter <Threshold> is carried out.

- THRESHOLD

Setting the threshold value determining footer printout.

For <Sum of measurements> parameter, threshold value is determined in measuring unit [g].

For <Measurements quantity> parameter, the unit is not determined, the provided value specifies carried out measurements quantity.

#### Printout/Enter mode

- PRINT/RELEASE button (manual operation)

Never – printout disabled.

First stable – first stable measurement is recorded.

Each stable – all stable measurements are registered.

Each – printout of all measurements (stable and unstable), for verified balance only stable measurements are printed out (as in <Each stable> setting).

- AUTOMATIC MODE

Never – printout disabled.

- First stable – first stable measurement is recorded upon loading of the weighing pan with a load; record of the next stable measurement result takes place only if the following conditions are met: weighing pan gets unloaded, measurement value lower than value of set threshold is displayed, a new load is placed on the weighing pan.
- Last stable – last stable measurement, registered prior unloading, is recorded. The record takes place only if the following conditions are met: weighing pan gets unloaded, measurement value lower than value of set threshold is displayed.
- With interval – select this value to start automatic printout and record of indications in WEIGHINGS database, carried out in a cyclic manner in a specified time intervals. The interval is set in [min] in <INTERVAL> parameter. Interval range is 1 - 9999 min.

**Caution!**

*Each weighing result is printed and recorded (stable and unstable for a non-verified balance, stable for a verified balance).*

*Automatic operation with interval starts at the moment of switching the function on. The first stable weighing result of value greater than THRESHOLD value is printed and recorded as the first measurement. The following measurements are printed with frequency set in INTERVAL parameter. To stop the automatic operation with interval, switch the option off.*

- THRESHOLD:  
Mass value obligatory for operation of automatic printout, set in grams.
- INTERVAL  
Record frequency for automatic operation with interval

**Printout**

Printout type related to a working mode. Printout is activated by pressing PRINT key on balance panel.

Available options:

- STANDARD PRINTOUT:  
Enables declaring content of the following printouts: HEADER, GLP PRINTOUT and FOOTER.  
Select <YES> parameter for the components that are to be printed on pressing printout activating function key.
- NON-STANDARD PRINTOUT:  
Enables selecting one of database-stored non-standard printouts from a list of <PRINTOUTS> menu, or designing a unique printout which is automatically added to the database.

**Caution!** For detailed instruction refer to section 14.7 of this user manual.

**Air buoyancy compensation**

Parameters allowing you to switch on the compensation, and to enter weighed sample density data and air density data.

**Caution!** Function valid for weighing mode exclusively. For detailed information regarding the operation and settings refer to the previous section of this user manual.

**15.8. Minimum Sample Weight**

Weighing mode settings comprise <Minimum sample weight> function. In order to use the function it is necessary to enter data related to minimum sample weight determination methods, and minimum sample weight values for a given method. The data must be entered to <Minimum sample weight> database. The database is empty in standard balance version.

**Determining minimum sample weight and adding data to the <Minimum sample weights> database can be carried out by an authorized “RADWAG” personnel exclusively.**

Should you use the minimum sample weight function, and need data on minimal sample weight to be entered to balance menu, please contact the local representative of “RADWAG” company.

Using reference weights, the authorized RADWAG employee determines minimum sample weight for specified tare containers. This operation is carried out at the place of use and in accordance with



requirements of the applied quality system. The obtained values are entered to balance software: <Minimum sample weights> database.

For a particular method of minimum sample weight determination, it is possible to define few tare values, along with values of minimum sample weights, expiry dates of the carried out measurements and entered data. The settings are not to be edited by a balance user.

<Minimum sample weight> function guarantees that the results of weighing operation are comprised within the set tolerance, in accordance with applied quality management system of particular company.

**Caution!** Function valid for weighing mode exclusively.

Available options:

- **METHOD**  
Option allowing you to designate used quality standard. Press METHOD field to open a window with a list of database-stored methods by means of which the minimum sample weights were determined. In order to add a new method go to <Databases /Minimum sample weights>.
- **MODE**  
**Block** – select to display pictograms informing you on status of weighed mass (weighed mass below/above minimum sample weight) and to disable accepting the measurement result if it is below the minimum sample weight limit.  
**Warn** – select to enable display of respective pictograms informing you about the measured mass (whether it is lower than the MSW value or higher than the MSW value). You can accept the measurement that is lower than the MSW value. Mind that on a printout it will be preceded by an asterisk (\*).

**Caution!** For information on how to enter a method for minimum sample weight go to section 29.14 <Databases /Minimum sample weights> of this user manual. New minimum sample weight values can be entered by an authorized RADWAG personnel exclusively.

### Weighing with use of <MINIMUM SAMPLE WEIGHT> function

If in the course of weighing you want to find out whether a particular measurement value is higher than the MSW value, specified for a given weighing range, then <Minimum sample weight> function must be on. To turn the function on go to weighing mode settings.

#### Procedure:

1. Press grey workspace area.
2. The following submenus are displayed: Settings, Buttons, Information, Printouts, Profile.
3. Select <Settings> menu - additional weighing process options.
4. Press <Minimum sample weight> field.
5. Wait for Minimum sample weight window to open, press <Method> field,

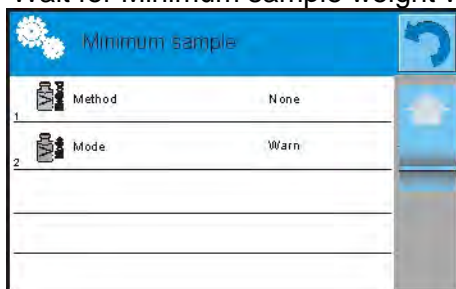

window with a list of database-stored methods opens.

6. Select respective method.
7. Previous menu is displayed.
8. Press <Mode> parameter.
9. Settings box is displayed, select respective option:  
**Block** – select to display pictograms informing you on status of weighed mass (weighed mass below/above minimum sample weight) and to disable accepting the measurement result if it is below the minimum sample weight limit.  
**Warn** – select to enable display of respective pictograms informing you about the measured mass (whether it is lower than the MSW value or higher than the MSW value). You can

accept the measurement that is lower than the MSW value. Mind that on a printout it will be preceded by an asterisk (\*).

10. Set the parameters and exit the menu.

11. Section presenting the weighing result comprises additional pictogram providing supplementary information. The pictogram changes in the course of weighing operation, it informs you on the weighed sample mass; the information is referred to the declared minimum sample weight value.



Weight value lower than the MSW value specified for a particular tare range.



Weight value higher than the MSW value specified for a particular tare range.

### MSW pictograms:

	Weight value lower than the specified MSW value.
	Weight value higher than or equal to the specified MSW value.
	Weight value lower than the specified MSW value; a pictogram with a clock informs on expiry of the minimum sample weight validity period (it is displayed two weeks before the determined expiry date).
	Weight value higher than the specified MSW value; a pictogram with a clock informs on expiry of the minimum sample weight validity period (it is displayed two weeks before the determined expiry date).
	The validity period of the minimum sample weight has expired. The minimum sample weight settings need to be modified. The minimum sample weight settings can be modified by an authorized RADWAG personnel exclusively.

**Caution!** If more than one reference tare value is programmed (with corresponding minimum sample weight mass) then the indicated value automatically moves to a range corresponding to the weight of the tared container. At the same time the required minimum mass is changed.

## 15.9. Cooperation with Titrators

In order to provide correct cooperation with TITRATORS, go to settings of standard printout content and set <Mass value for a titrator> parameter to <Yes> value. With this, other variables for the printout are turned off.

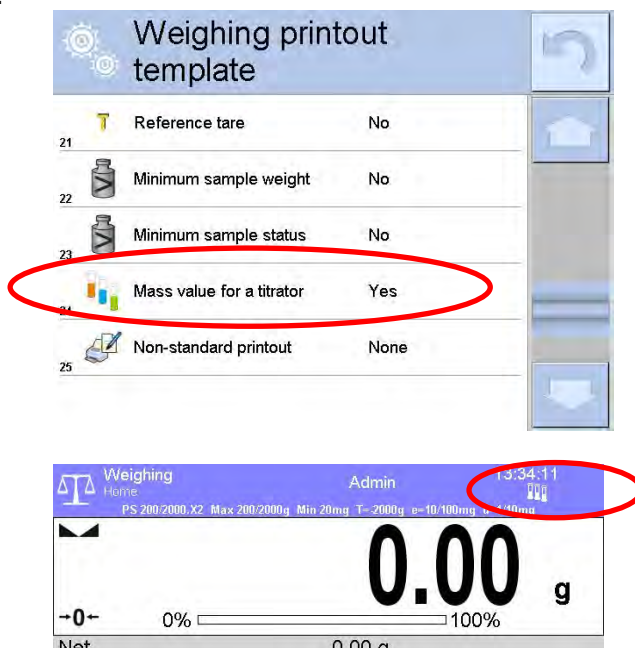

The pictogram informs on special format of mass printout, permissible by TITRATORS.

## 15.10. Ambient Conditions - Vibrations

Vibrations are a major cause of errors. Since the vibrations spread in all directions, the vibrations analysers and meters must carry out measurement in three axes concurrently. Ambient conditions module implemented in RADWAG balances of 4Y series features such option.

Analytical balances are precise weighing instruments therefore even insignificant oscillations influence their operation. Humans are most often unable to sense vibrations. In order to detect them, it is necessary to use special equipment. Vibrations sensor, along with a module that analyses the influence of the vibrations onto the measurement, informs the user in a real time on the possibility of occurrence of error caused by high-frequency vibrations.

Usually the vibrations are dampened with use of anti-vibration tables. Signalling device, i.e. ambient conditions module equipped with a vibrations sensor, is used to support the process of vibrations dampening. Such device comes standard with each 4Y series balance. With use of the said signalling device it is possible to evaluate workstation conditions and if necessary to find more convenient place of use. It is often impossible to find a place where no vibrations occur, however the signalling device allows the operator to determine when and where to expect vibrations of the lowest-frequency.

Due to the following 3 factors: specified values of free vibrations, resolution, and permissible weighing instrument errors, the analysis must be carried out with regard to the right effective value (rms value) and bandwidth. Such analysis is performed on each 4Y series balance in a real time. In case of the module that is in-built into balances manufactured by RADWAG, the filters analyse those frequencies to which the weighing devices are sensitive. In case of balances, effective value (rms value) measured from 3 axes and for a particular time interval is given, such value provides information on amplitude and history of disturbances.

Radwag has designed analysis method and selected permissible vibrations thresholds respectively to make signalling device operation both effective and convenient (not troublesome). Balance screen displays balance-registered vibrations level in percent.

Vibrations threshold cannot be changed, however the operator can modify settings in a way ensuring that alerts are displayed in the most convenient way, depending on the needs. By default the set value is 100%.

Example of settings modification:

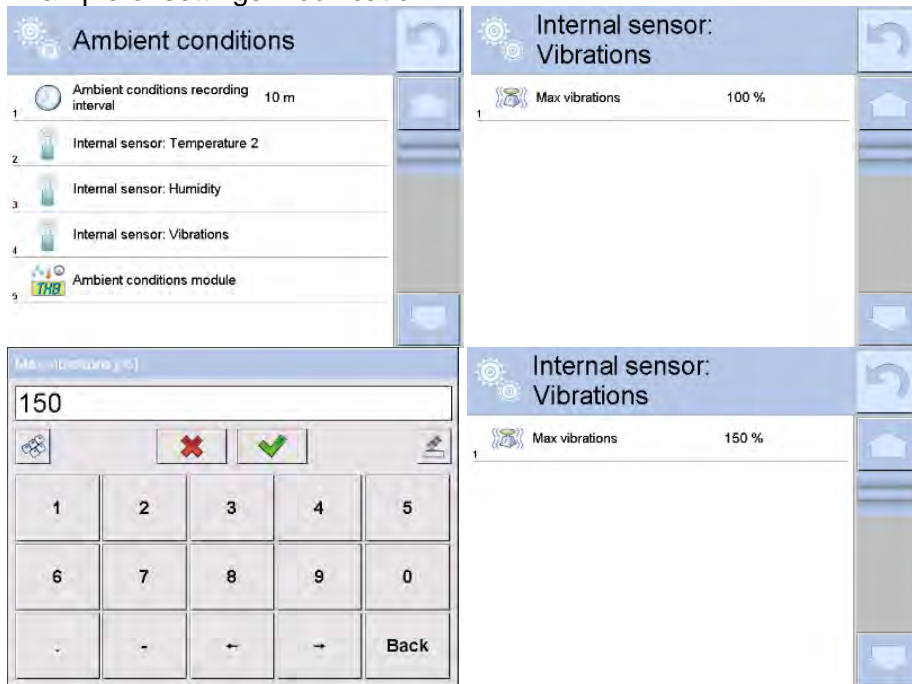

For better understanding, analyse the following example (the values used below are exemplary ones, they were not taken from the balance).

1. Assumed vibrations threshold set by default on 4Y series balance: 100mm/s<sup>2</sup>.
2. Max vibrations value: 100% (threshold for alert display – pictogram colour change, from green to red). Pictogram colour is green for vibrations within 0 - 100mm/s<sup>2</sup> range, for vibrations value of 101mm/s<sup>2</sup>, the pictogram changes to red.
3. Max vibrations value: 150%. Pictogram colour is green for vibrations within 0 - 150mm/s<sup>2</sup> range, for vibrations value of 151mm/s<sup>2</sup>, the pictogram changes to red.

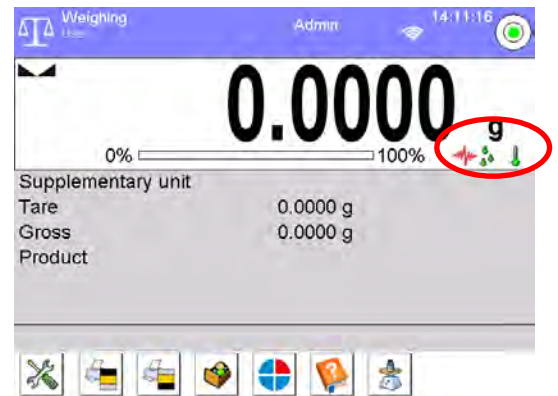
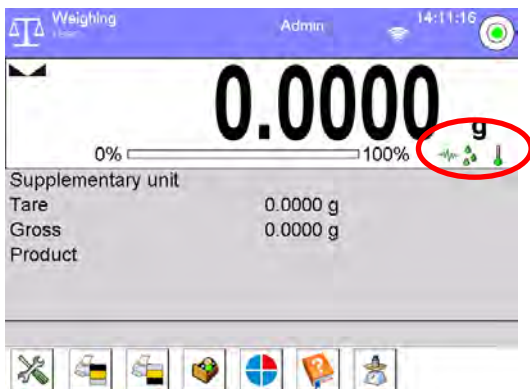

Vibrations are signalled by a respective pictogram displayed in the weighing result window.

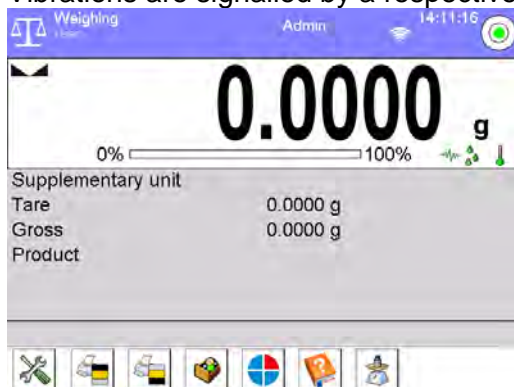

Upon pressing vibrations pictogram, window with current values measured by sensors is displayed. Displayed vibrations value (IS V) is the effective value registered within the most recent 2 seconds.



This value is refreshed every 2 seconds. If the screen displays 100% value, this means that vibrations have reached the threshold set by RADWAG.

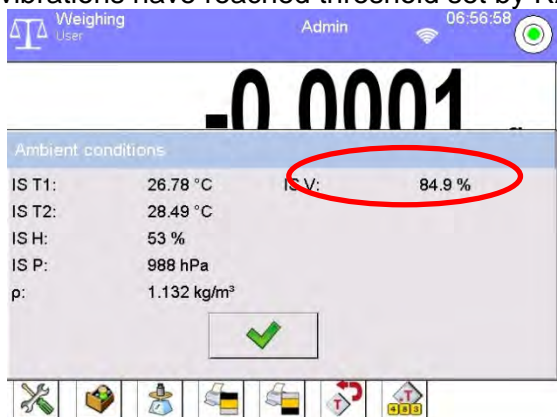

Vibrations are recorded in the database, this allows to analyse history of ambient conditions quality.

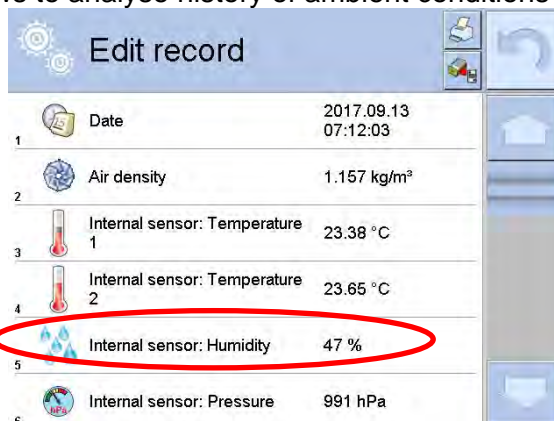
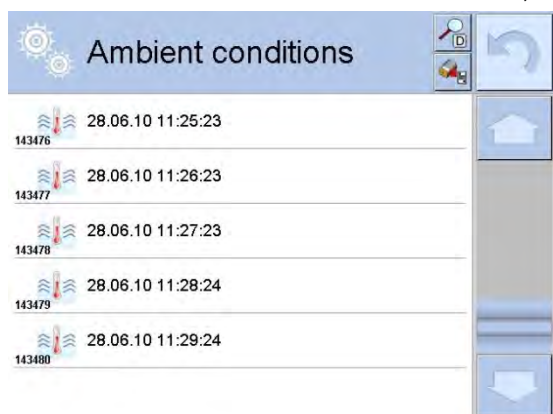

Effective value of vibrations registered by the balance over a declared time interval is saved (from the moment of the last record) – Setup/Ambient conditions/Ambient conditions recording interval.

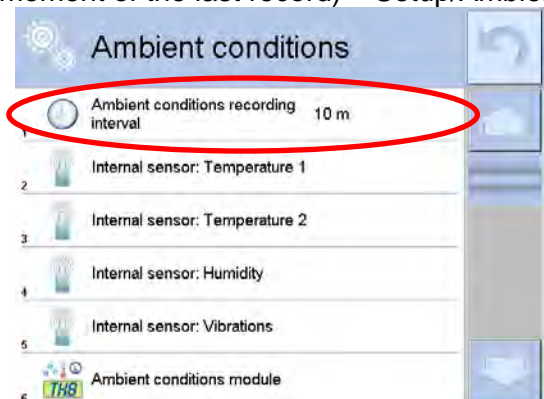

By default the interval is set to 10 min, this value may range between 1 min - 60 min. Record analysis allow the user to select the most optimal time of the day for the measurements performance, i.e. time when the environmental conditions influence the vibrations the least. Mind that there are places where the most convenient working conditions occur after-hours.

Along with each measurement, data on ambient conditions alerts and level of vibrations, that occurred in the course of the measurement, is saved.

Weighing data		
367	19.04.10 07:48:13	0.01 g
368	09.05.10 13:02:21	-0.25 g
369	27.06.10 09:22:34	62.22 g
370	27.06.10 09:33:41	61.6935 g
371	28.06.10 08:54:26	0.6099 g

Edit record	
1	Date 28.06.10 08:54:26
2	Mass 0.6099 g
3	Tare 0 g
4	Stable Yes
5	Air buoyancy compensation No
6	Product

Edit record	
10	Warehouse
11	Packaging
12	Result control
13	Weighing platform number 1
14	Level status Yes
15	Ambient conditions alerts No



Edit record	
14	Ambient conditions alerts No
15	Air density 1.158 kg/m <sup>3</sup>
16	Vibrations 72.5 %

## 16. PARTS COUNTING

< **Parts counting**> is a working mode enabling you to determine quantity of small pieces of the same mass, which determination is done on the basis of reference weight value of single piece. The single piece weight value can be:

- determined using a reference quantity of parts subjected to weighing,
- acquired from database of products,
- entered manually as a numeric value.

### Mode activation procedure:

1. Go to the home screen, press  pictogram, <Working modes> submenu with list of working modes opens.
2. Select < Parts counting> mode, the home screen is displayed automatically, it features  pictogram.

### Parts Counting mode screen



1. Setup – press to access balance menu.
2. Print header – press to print data declared in the header.
3. Print footer – press to print data declared in the footer.
4. Products Database – press to select products from products database.
5. Set part mass – press to edit field for entering mass of a single part.
6. Determine part mass – press to set mass of a single part using reference sample comprising specified number of parts, e.g.: 10 pcs, 24 pcs, etc.

### 16.1. Mode Related Settings

The supplementary settings enable you to adjust the working mode to your needs and requirements.

#### Procedure:

1. Press grey workspace area, menu is displayed.
2. Press <Settings> parameter. List of functions related to Parts Counting mode is displayed:

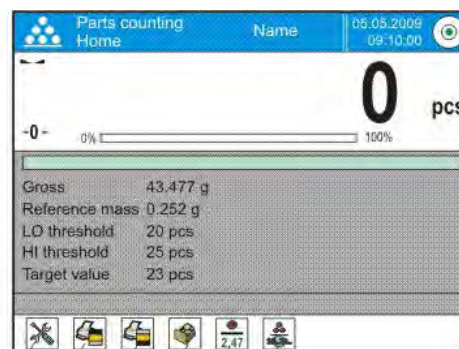

#### Functions:

- **ACAI**, Automatic Accuracy Correction:
  - YES, weight value of a single piece to be updated.
  - NO, weight value of a single piece not to be updated.

- **Minimum reference sample mass:** 1 unit, 2 units, 5 units, 10 units; minimum mass value of a single piece. If this condition is not met, the counting process will not start.
- **Result control**
  - YES, set to print and save only those measurements which are comprised within the Lo and Hi thresholds.
  - NO, set to print and save all measurements .
- **Other functions in <Settings> parameter**

To find out more about the remaining functions refer to section 15.7 of this user manual, *Additional Parameters for a Weighing Process*.

#### Means of operation of ACAI function:

1. pieces quantity upon adding must increase,
2. pieces quantity upon adding cannot increase more than twice,
3. pieces quantity upon adding must be comprised within  $\pm 0.3$  tolerance of total value,
4. the weighing result must be stable.

### 16.2. Parts Counting – Quick Access Buttons



Each working mode features automatically displayed set of default on-screen quick access buttons. The set can be modified, i.e. you can add out-of-list quick access buttons to it. Such operation requires particular permissions level.

You can add special buttons enabling quick access to function of determination of single piece mass, where the single piece mass is determined on the basis of reference mass, given for particular quantity of pieces:



### 16.3. Setting Reference Sample Mass by Entering Mass of a Single Part





#### Procedure:

1. Press  Set part mass> button, <Reference sample mass> edit box featuring an on-screen keyboard is displayed.
2. Enter respective value and press  button for confirmation, < Parts counting> working mode is run with automatically set mass of a single part.

**Caution!** If the value of entered single part mass is lower than 0.1 of the reading unit, then the following message is displayed: <Value too low>.

### 16.4. Setting Reference Sample Mass by Determining Mass of a Single Part

#### Procedure:

1. Put the container on a weighing pan and tare it.
2. Press  button (Determine part mass), <Reference sample quantity> edit box featuring an on-screen keyboard is displayed.
3. Enter respective value and press  button to confirm. The following message is displayed: **<Number of parts to be loaded: xx>** (where **xx** – previously entered value).
4. Load the weighing pan with declared amount of parts. When the indication is stable ( pictogram is displayed), press  button to confirm the mass.
5. Single part mass is calculated automatically, < Parts counting> working mode is run and the weighing device displays quantity of single parts (**pcs**).

**Caution!**



Remember!

- Total weight value of all parts loaded onto the weighing pan cannot be greater than the max capacity value.
- Total weight value of all parts loaded onto the weighing pan cannot be lower than the value determined by <Minimum reference sample mass> parameter. Unless this condition is met, the weighing instrument displays a message: <Sample mass too low>.
- Single part mass value must be equal to or greater than 0.1 of the reading unit. Unless this condition is met, the weighing instrument displays a message: <Single part mass too low>.

## 16.5. Setting Reference Sample Mass by Acquiring Mass of a Single Part from Database

Each product recorded in a database of products features set of information which allows to identify it. Among the information there is weight value used during part counting process.

**Procedure:**

Enter <Parts counting> mode and press <Products> database pictogram. Select respective product from the list.

### Entering reference sample mass to weighing device memory

Procedure for entering single part mass to products database:

1. Press <Setup> button, next press <Databases> entry and select Products database.
2. Press <Products> button.
3. Press respective product name and modify <Mass> field, [5].
4. Go back to <Parts counting> mode.

Procedure for entering single part mass to products database when there is no data entered yet:

- a) Press <Setup> button, next press <Databases> entry and select Products database.
- b) Press <Add> button.
- c) Fill in or product-related fields and modify <Mass> field, [5].
- d) Go back to <Parts counting> mode.

## 16.6. Single Part Mass Update in a Database

Determined single part mass can be assigned to a product in the database of products. This option is applied while using ACAI (Automatic Accuracy Correction) function in order to determine part mass with high accuracy.

**Procedure:**

1. Determine single part mass.
2. Press <Products> database.
3. Press and hold name of a product for which mass value is to be updated.
4. Context menu opens.
5. Press <**Assign reference sample mass**> button, reference sample mass for the product is recorded as <**Mass**>.

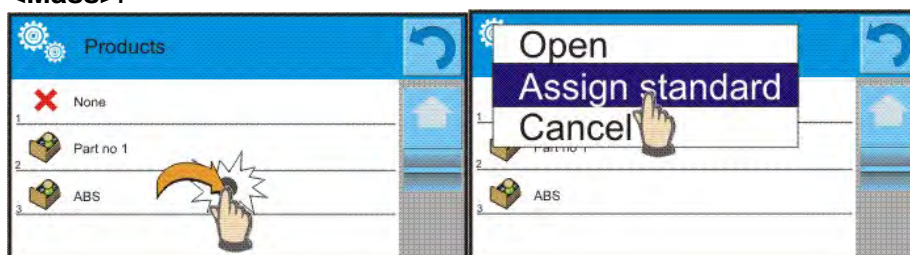

## 16.7. Parts Counting Procedure

First, it is necessary to obtain weight value of a single piece. Select one of the available options:

- Enter weight value for a single part (section 16.3), next put parts to be counted on the weighing pan, parts quantity is displayed.
- Determine mass of a single part from a given quantity of parts (section 16.4.). ACAI function  pictogram is displayed (providing that the function is active). Next put parts to be counted on the weighing pan, parts quantity is displayed.
- Acquire weight value for a single part from the database (section 16.5). To do it, you have to select respective product. Now put parts to be counted on the weighing pan, parts quantity is displayed.

**Caution!** It is necessary to tare any additional elements (packaging) prior to counting process start.

## 16.8. Checkweighing for Parts Counting Mode

Parts counting process can be aided by checkweighing function, i.e. control whether indication is within the set thresholds.

Checkweighing requires setting values for two thresholds:

- Min threshold [Min= ... pcs.]
- Max threshold [Max= ... pcs.]

and setting YES value for Bar graph. The Bar graph displays relation: CURRENT PARTS QUANTITY/CHECKWEIGHING THRESHOLDS.

In order to define Min and Max thresholds' values open Products database and edit the Product

record or use  Checkweighing thresholds> quick access button.

### Procedure:

1. Press grey workspace, next select <Information> parameter.
2. Set Bar graph to YES value, return to parts counting mode.
3. Press grey workspace, next select <Buttons> parameter.
4. Assign <Checkweighing Thresholds> parameter to one of the quick access buttons.
5. Return to parts counting mode.
6. Press  Checkweighing thresholds> button and enter Min and Max thresholds values. Return to parts counting mode.
7. Bar graph is displayed, its colour corresponds to the status of parts counting process.
  - yellow: current parts quantity below the set Min threshold value.
  - green: current parts quantity within the set thresholds.
  - red: current parts quantity above the set Max threshold value.

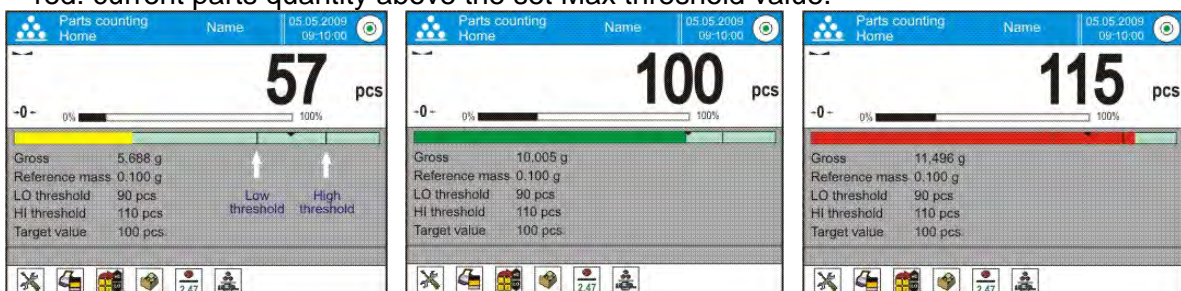

## 16.9. Dosing in Parts Counting Mode

Parts counting process can be aided by dosing function, i.e. control whether indication does not exceed the set target value.

Dosing requires setting a target value, e.g. 100 parts, and a % tolerance. The bar graph displays the

target value as a bracket. In order to define target value press quick access button,  Target Value>.

**Procedure:**

1. Press grey workspace, next select <Information> parameter.
2. Set Bar graph to YES value, return to parts counting mode.
3. Press grey workspace, next select <Buttons> parameter.
4. Assign <Target value> parameter to one of the quick access buttons.
5. Return to parts counting mode.
6. Press  Target Value> button and enter value corresponding to parts quantity you want to have.
7. If tolerance option is used, determine tolerance value (0 – 100%).
8. Bar graph is displayed. It provides the following information:
  - current parts quantity on the weighing pan (indicated by means of colour – see section 16.7.),
  - target mass value (black marker).

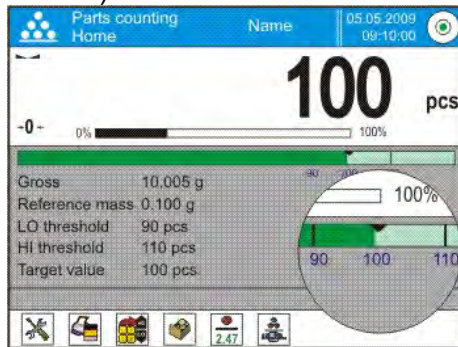

**Caution!** The checkweighing and dosing functions can operate simultaneously in the parts counting mode. In such case the dosing tolerance is controlled by Min and Max thresholds of the checkweighing function.

**17. CHECKWEIGHING**

<  **Checkweighing** > is a working mode using two thresholds (Min and Max) for control of samples weight. Usually the weight is considered to be correct if it is comprised within threshold values.

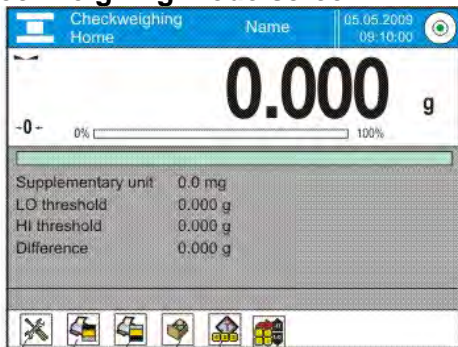

**Checkweighing mode screen**



1. Setup – press to access balance menu.
2. Print header – press to print data declared in the header.
3. Print footer – press to print data declared in the footer.
4. Products Database – press to select products from products database.
5. Set Tare – press to enter tare.
6. Checkweighing thresholds – press to declare Min and Max threshold values.

**17.1. Making Use of Checkweighing Thresholds**

There are two methods for making use of the checkweighing thresholds:

- selecting product  > with Min and Max threshold declared,
- entering numeric value for the thresholds, ; in this case thresholds do not refer to any product.



### Procedure 1 – selecting product from Products Database:



1. Press  button (Product database), list of products is displayed.
2. Select the product that is to be weighed.
3. Threshold values are displayed automatically within an Info field.
4. Bar graph is displayed, its colour corresponds to the current status of mass:
  - yellow: mass value lower than Min threshold value,
  - green: mass value higher than Min threshold value and lower than Max threshold value,
  - red: mass value higher than Max threshold value.

### Procedure 2 – entering checkweighing thresholds manually:



1. Press  button (Checkweighing thresholds).
2. Press Min threshold button and enter its value.
3. Press  button to confirm.
4. Press Max threshold button and enter its value.
5. Press  button to confirm.

**Caution!** Max threshold value has to be greater than Min threshold value.

## 17.2. Mode Related Settings

To find out more about the remaining functions refer to section 15.7 of this user manual, *Additional Parameters for a Weighing Process*.

## 18. DOSING



<  Dosing > is a working mode that facilitates dispensing process, wherein the dispensing takes as long as it is necessary to obtain a pre-defined target weight.

### Dosing mode screen

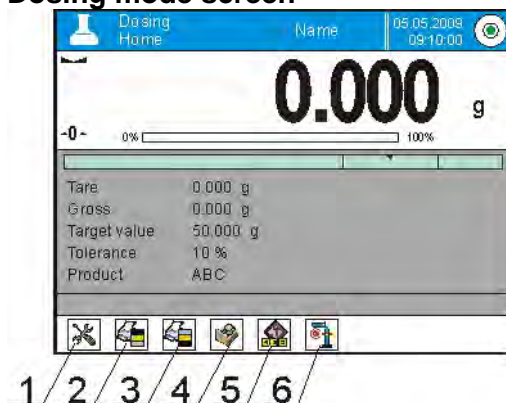

1. Setup – press to access balance menu.
2. Print header – press to print data declared in the header.
3. Print footer – press to print data declared in the footer.
4. Products Database – press to select products from products database.
5. Set Tare – press to enter tare.
6. Target value - press to declare target value.

### 18.1. Making Use of Products Database in the Course of Dosing Operation

You can use target value assigned to a product or values recorded in Product Database. Additionally it is possible to define temporary target values. In case of Product Database the target value is value entered in the mass field.

### Procedure 1 – selecting product from Products Database:



1. Press  button (Product database), list of products is displayed.
2. Select the product that is to be weighed.
3. Target and tolerance values are displayed automatically within the Info field.



4. Target value is displayed with minus sign.

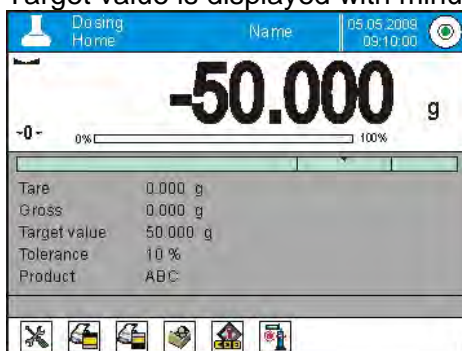

5. Bar graph is displayed, its colour corresponds to the current status of mass:

- yellow: mass value lower than 'target value - tolerance value',
- green: mass value within permissible tolerance range: 'target value +/- tolerance'
- red: mass value greater than 'target value + tolerance value'.

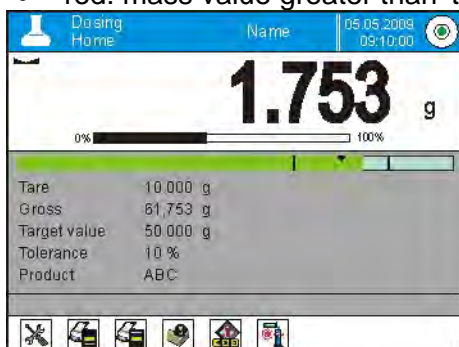

**Procedure 2** – entering checkweighing thresholds manually:



1. Press  button (Target value).
2. Window for entering target value and tolerance is displayed, provide the values.
3. Return to weighing.

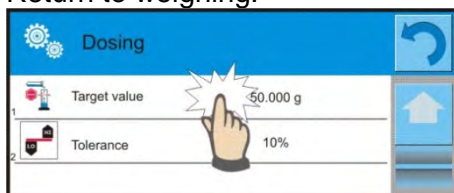

**Caution!** For a product acquired from Products Database the Target Value and Tolerance data are already given. The data can be edited and modified.

## 18.2. Mode Related Settings

To find out more about the remaining functions refer to section 15.7 of this user manual, *Additional Parameters for a Weighing Process*.

## 19. PERCENT WEIGHING AGAINST REFERENCE SAMPLE MASS



< **Percent weighing** > is a working mode for comparison of the measured sample's weight with the reference mass. The result is expressed in [%].

PERCENT WEIGHING function can be aided by DOSING and CHECKWEIGHING functions. Mind that these are not started automatically, neither is bar graph.

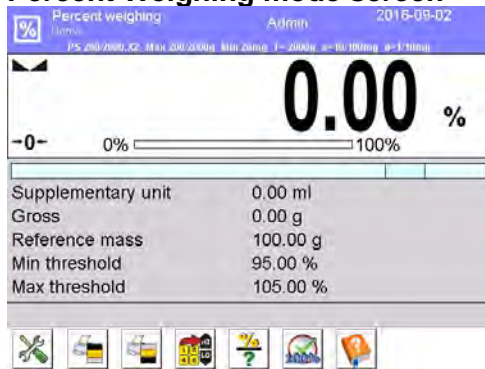

## Percent Weighing mode screen





1. Setup – press to access balance menu.
2. Print header – press to print data declared in the header.
3. Print footer – press to print data declared in the footer.
4. Products Database – press to select products from products database.
5. Percent weighing: press to set reference mass.
6. Percent weighing: press to set as 100%.

## 19.1. Sample Mass and Reference Sample Mass Comparison

Comparison methods:

- Entering reference mass, to do it press  button (Set reference mass).
- Accepting mass of load resting on the weighing pan as a reference mass, to do it press  button (Set as 100%).
- selecting product, out of products database, for which 'mass' parameter has been defined; to do it press  button (Products database).



**Procedure 1** – entering reference mass manually

1. Press  button (Set reference mass).
2. Enter the reference mass value and press  button to confirm.
3. Weighed products mass is compared to the reference mass, the weight difference is displayed in [%].

**Procedure 2** – accepting mass of load resting on the weighing pan as a reference mass

1. Load the weighing pan with the sample, wait for a stable indication.
2. Press  button (Set as 100%).
3. 100.000% indication is displayed, weight of the product resting on the weighing pan is accepted as reference mass, it is automatically recorded and displayed in reference mass field.
4. Unload the weighing pan.
5. From now on the weighed products mass is compared to the reference mass, the weight difference is displayed in [%].

**Procedure 3** – selecting product from Products Database:

1. Press  button (Products database). Select product that is to be weighed.
  2. Info field automatically displays modified information concerning reference mass.
  3. Product-related reference mass is automatically recorded and displayed in reference mass field.
- Press  button to open reference mass field.
4. 0.00 % indication is displayed (for unloaded pan).
  5. From now on the weighed products mass is compared to the reference mass, the weight difference is displayed in [%].

## 19.2. Checkweighing and Dosing in Percent Weighing Mode

PERCENT WEIGHING function can be aided by DOSING and CHECKWEIGHING functions. In order to make them accessible assign them to an on-screen button. Remember to provide percent values for both of the functions.

### Procedure:

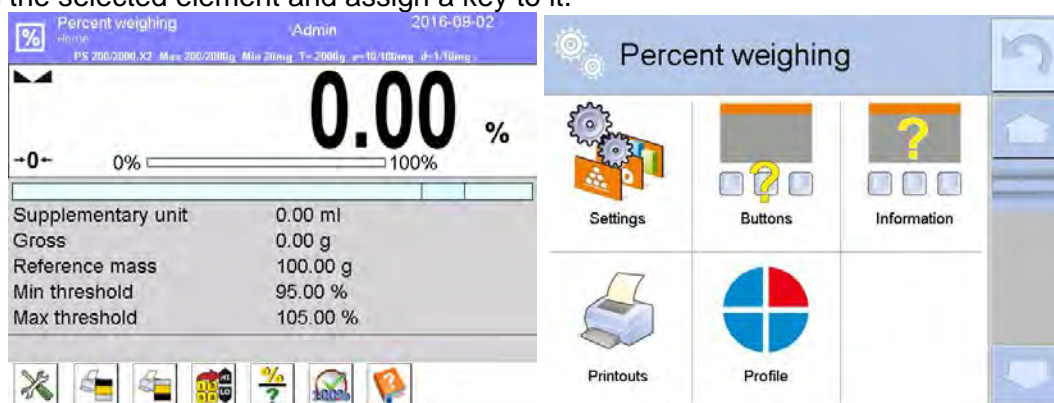

1. Press grey workspace area.
2. The following submenus are displayed: Settings, Buttons, Information, Printouts, Profile.
3. Select <Buttons> menu.
4. List of on-screen buttons, function buttons and proximity sensors is displayed.
5. Press the selected element and assign a key to it.



## CHECKWEIGHING

Checkweighing function facilitates control of sample mass, mind that Min and Max thresholds, given in [%], are required.

### Procedure:



1. Press  button (Checkweighing thresholds).
2. Press Min threshold button and enter its value [%].
3. Press  button to confirm.
4. Press Max threshold button and enter its value [%].
5. Press  button to confirm.

**Caution!** Max threshold value has to be greater than Min threshold value.

## DOSING



Dosing function requires target value to be specified (it must be given in [%]) along with dosing tolerance, i.e. permissible +/- surplus or shortfall.

### Procedure:

1. Press  button (Target value).
2. Enter the target value in [%].
3. Set tolerance value, if required.
4. Press  button to confirm.
5. Press Min threshold button and enter its value [%].
6. Press  button to confirm.

## 19.3. Bar Graph

The DOSING and CHECKWEIGHING functions are aided by a graphic indication, i.e. bar graph. Example of simultaneous operation of DOSING and CHECKWEIGHING functions is presented below.

-  < Checkweighing thresholds > settings: Min = 90%, Max = 110%.
- target value = 105%; tolerance = 5% ,
- reference mass = 19.986 g  >.

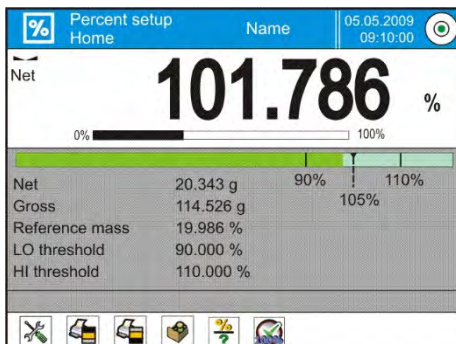

## 19.4. Mode Related Settings

To find out more about the remaining functions refer to section 15.7 of this user manual, *Additional Parameters for a Weighing Process*.

## 20. DENSITY

 < Density > is a working mode enabling to determine density of:

- solid bodies,
- liquids,
- air (available for XA 4Y),
- various substances with use of pycnometer.

In order to operate this mode, a density determination kit (supplementary equipment) is required.

### Density mode screen

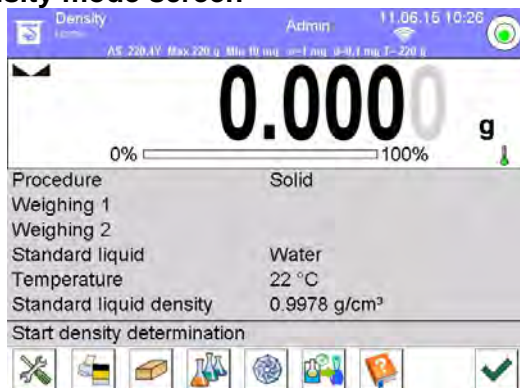

1. Setup – press to access balance menu.
2. Print header – press to print data declared in the header.
3. Print footer – press to print data declared in the footer.
4. Solid density
5. Liquid density
6. Air density
7. Pycnometer



## 20.1. Density Determination Kit

Kit intended for XA balances:

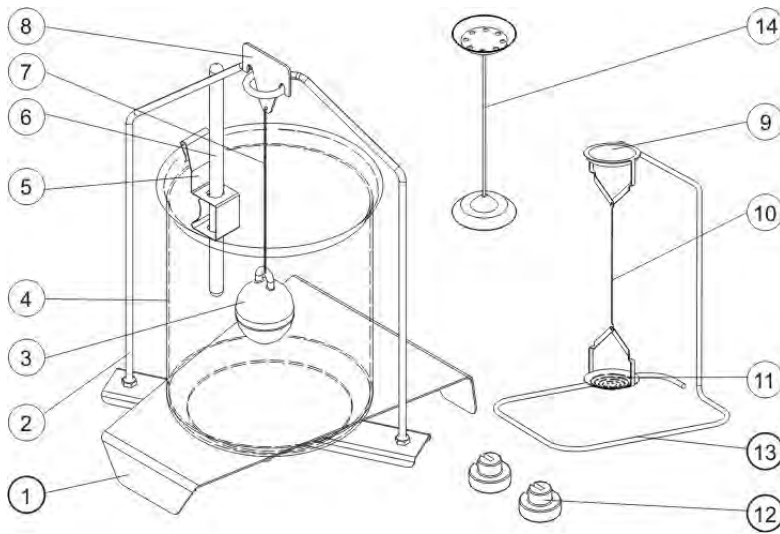

- 1 Beaker base
- 2 Stand
- 3 Sinkers
- 4 Beaker
- 5 Thermometer holder
- 6 Thermometer
- 7 Flexible connector for sinker
- 8 Hanger
- 9 Top weighing pan for solids density determination
- 10 Flexible connector for weighing pans
- 11 Bottom weighing pan for solids density determination
- 12 Additional sinker
- 13 Additional stand for a set of pans or a sinker
- 14 Additional set of weighing pans for density determination of solids with density lower than density of water

### Caution!

Components of density determination kit shall be stored in a box.

Weighing pans and sinker must not be put directly on a table, this might cause their damage. Weighing pans and sinker, if not in use, must be put on an additional stand.

## 20.2. Assembly

XA balances

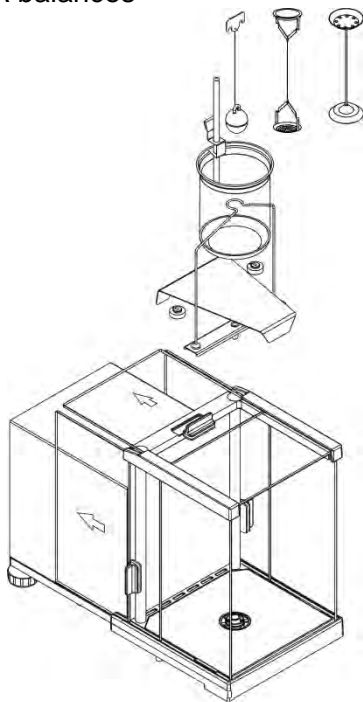

### Caution!

If the kit has been installed and -NULL- message is displayed than load the balance with weights set (12) and zero or tare the indication. Thus prepared balance can be used for density determination.

## 20.3. Solids Density Determination

Prior the procedure start, it is necessary to set process-related parameters:

- Liquid type (distilled water, ethanol, other liquid with determined density)





- Liquid temperature (required if either distilled water or ethanol is used as liquid for measurement performance)
- Liquids density (parameter set automatically, after the temperature has been entered, if either distilled water or ethanol is used as liquid; in case of using liquid other than distilled water or ethanol, it is necessary to enter its density manually).

The density of solids is calculated using the following formula:

$$\rho = \frac{A}{A-B} \rho_o$$

- $\rho$  - density of a sample
- A - sample mass measured in the air
- B - sample mass measured in liquid
- $\rho_o$  - liquid density

**Procedure:**

1. Install density determination kit.
2. In order to record density value for a particular product in products database, go to <Settings> menu, set <Assign density to product> parameter and press <Product> quick access button to make the product active.
3. Press < Density of solids> button.
4. Respective menu is displayed, using it set the following parameters: Standard liquid, Temperature, Standard liquid density.
5. Press < START> button.
6. Process of density determination begins.
7. Load the TOP density kit pan with a sample, wait for a stable measurement result and press < > button.
8. Load the BOTTOM density kit pan (immersed in liquid) with a sample, wait for a stable measurement result and press < > button.
9. Density result is displayed.
10. Press < > button to complete the procedure.

**Caution!**

Press < > button to start new density determination process with the same settings.

**20.4. Liquids Density Determination**

In order to determine density of liquid first determine sinker’s density in the air, next in the liquid. The density of liquid is calculated using the following formula:

$$\rho = \frac{A - B}{V} + d$$





- $\rho$  - density of liquid
- A - sinker mass measured in the air
- B - sinker mass measured in water
- V - sinker volume
- d - air density (max 0.001 g/cm<sup>3</sup>)

Install the density determination kit, and enter sinker’s volume to balance’s memory.

- Press < Liquid density> button.

- A respective menu is displayed, using it press <  Sinkers volume> button and enter sinker's volume value, take it from the sinker's hanger.
- Process of density determination begins.

**Procedure:**

1. Install density determination kit.
2. In order to record density value for a particular product in products database, go to <Settings> menu, set <Assign density to product> parameter and press <Product> quick access button to make the product active.
3. Press <  START> button.
4. Follow the displayed commands.
5. Carry out measurement in the air, wait for a stable measurement result and press <  > button.
6. Carry out measurement in the tested liquid, wait for a stable measurement result and press <  > button.
7. Density result is displayed.
8. Press <  > button to complete the procedure.

**Caution!**

Press <  > button to start new density determination process with the same settings.

**20.5. Air Density**

<  > Air density value is one of numerous data required for calculation of measurement result correction, which correction is an effect of air BUOYANCY compensation. Another value required for the calculation is weighed sample density. The function of air density determination is enabled only in balances with reading unit lower than d=1mg. Determining density of air requires use of a dedicated set of mass standards (additional equipment), specific for a given balance model.

**Procedure:**

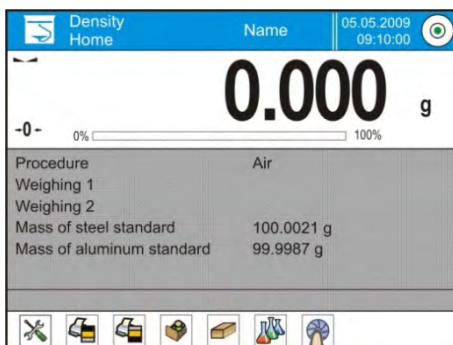

1. Press <  Air density> button.
2. Menu of Air Density function is displayed.
- 3.



4. Press field for entering weight value of steel mass standard, enter the value as provided in calibration certificate.

5. Press field for entering weight value of aluminium mass standard, enter the value as provided in its calibration certificate.
6. Press field for entering density value of steel mass standard, enter the value.
7. Press field for entering density value of aluminium mass standard, enter the value.
8. Press START field, air density determination begins.



9. Load the pan with steel mass standard, wait for a stable measurement result and press  button.
10. Load the pan with aluminium mass standard, wait for a stable measurement result and press  > button.
11. Density result is displayed.
12. Press  button to complete the procedure.

The value of determined air density is automatically assigned to <Air density> parameter in <Settings/ Air buoyancy compensation> menu for weighing working mode.

## 20.6. Determining Density Using Pycnometer

Prior the procedure start, it is necessary to set process-related parameters:



- Pycnometer weight (if pycnometer weight is known, the measurement is carried out once when the pycnometer is filled with substance).
- Pycnometer volume.



The density of solids is calculated using the following formula:

$$\rho = \frac{A}{A - B} \rho_o$$

- $\rho$  - density of a sample
- A - sample mass measured in the air
- B - sample mass measured in liquid
- $\rho_o$  - liquid density

### Procedure 1 – when the pycnometer weight has been entered





1. In order to record density value for a particular product in products database, go to <Settings> menu, set <Assign density to product> parameter and press <Product> quick access button to make the product active.
2. Press  <Pycnometer> button.
3. Respective menu is displayed, using it set the following parameters: pycnometer weight, pycnometer volume.
4. Press  <START> button.
5. Process of density determination begins.
6. Fill in the pycnometer with tested substance, follow the pycnometer guidelines.

7. Load the pan with a pycnometer, wait for a stable measurement result and press  button.
8. Density result is displayed.
9. Press  button to complete the procedure.

**Caution!**

Press  button to start new density determination process with the same settings.

**Procedure 2 – when pycnometer weight has not been entered**

1. In order to record density value for a particular product in products database, go to <Settings> menu, set <Assign density to product> parameter and press <Product> quick access button to make the product active.
2. Press  Pycnometer> button.
3. Respective menu is displayed, using it set the following parameters: Pycnometer volume.
4. Press  START> button.
5. Process of density determination begins.
6. Load the pan with a pycnometer, wait for a stable measurement result and press  button.
7. Take the pycnometer off the pan, fill it with tested substance, follow the pycnometer guidelines.
8. Load the pan with a pycnometer containing the substance, wait for a stable measurement result and press  button.
9. Density result is displayed.
10. Press  button to complete the procedure.

**Caution!**

Press  button to start new density determination process with the same settings.

**20.7. Mode Related Settings**

The supplementary settings enable you to adjust the working mode to your needs and requirements.

- Request sample number: NO - sample number not required, single measurement; YES - sample number required, series of measurements.
- Measuring unit: [g/cm<sup>3</sup>], [kg/m<sup>3</sup>], [g/l]; selected unit is valid for all density determining options and for final indication printouts.
- Assign density to a product: YES/NO; YES - the software automatically assigns the value of determined density of solid or liquid to <Density> parameter in a product record of the database of products. To use this function first enter products database and select a product for which the density procedure is carried out. Next start density determining process (if density has already been determined for this product, it is replaced with new value).
- Tare mode
- Printout/Enter mode
- Printout

To find out more about the remaining functions refer to section 15.7 of this user manual, *Additional Parameters for a Weighing Process*.

## 20.8. Printouts

Printouts option enables you to determine content of a particular standard printout, and to define non-standard printout.

Standard printout comprises four internal blocks, each containing different variables. Variable settings: YES – print; NO – do not print.

Settings for header, GLP and footer printouts are to be found in section 14.7. For density printout template read below.

You can design content of a report for each of carried out procedures. Upon pressing <Density printout template> parameter a window is opened where you can set content of a particular report.

Particular reports content:

SOLID	LIQUID	AIR	PYCNOMETER
<ul style="list-style-type: none"> <li>• Working mode</li> <li>• Procedure</li> <li>• Sample no.</li> <li>• Operator</li> <li>• Balance type</li> <li>• Balance S/N</li> <li>• Date</li> <li>• Time</li> <li>• Standard liquid</li> <li>• Temperature</li> <li>• Density of standard liquid</li> <li>• Weighing 1</li> <li>• Weighing 2</li> <li>• Density</li> <li>• Volume</li> <li>• Product</li> <li>• Warehouse</li> <li>• Customer</li> <li>• Empty line</li> <li>• Dashes</li> <li>• Signature</li> <li>• Non-standard printout</li> </ul>	<ul style="list-style-type: none"> <li>• Working mode</li> <li>• Procedure</li> <li>• Sample no.</li> <li>• Operator</li> <li>• Balance type</li> <li>• Balance S/N</li> <li>• Date</li> <li>• Time</li> <li>• Sinker volume</li> <li>• Temperature</li> <li>• Weighing 1</li> <li>• Weighing 2</li> <li>• Density</li> <li>• Product</li> <li>• Warehouse</li> <li>• Customer</li> <li>• Empty line</li> <li>• Dashes</li> <li>• Signature</li> <li>• Non-standard printout</li> </ul>	<ul style="list-style-type: none"> <li>• Working mode</li> <li>• Procedure</li> <li>• Sample no.</li> <li>• Operator</li> <li>• Balance type</li> <li>• Balance S/N</li> <li>• Date</li> <li>• Time</li> <li>• Mass of steel standard</li> <li>• Mass of aluminium standard</li> <li>• Density of steel standard</li> <li>• Density of aluminium standard</li> <li>• Weighing 1</li> <li>• Weighing 2</li> <li>• Density</li> <li>• Product</li> <li>• Warehouse</li> <li>• Customer</li> <li>• Empty line</li> <li>• Dashes</li> <li>• Signature</li> <li>• Non-standard printout</li> </ul>	<ul style="list-style-type: none"> <li>• Working mode</li> <li>• Procedure</li> <li>• Sample no.</li> <li>• Operator</li> <li>• Balance type</li> <li>• Balance S/N</li> <li>• Date</li> <li>• Time</li> <li>• Pycnometer mass</li> <li>• Pycnometer volume</li> <li>• Weighing 1</li> <li>• Weighing 2</li> <li>• Density</li> <li>• Product</li> <li>• Warehouse</li> <li>• Customer</li> <li>• Empty line</li> <li>• Dashes</li> <li>• Signature</li> <li>• Non-standard printout</li> </ul>

## 20.9. Performed Density Determinations Report

Upon completed density determination processes (solid body, liquid, air) a report is generated. The report is saved to <Density reports> database. The files are named by the date and time (hour) of density process performance.

An example of solid density determination report:

```

----- Density -----
----- Solid body -----
Operator                               Admin
Balance S/N                             400015
Date                                    2011.10.07
Time                                    10:08:09



```

Standard liquid	Water
Temperature	22 °C
Density of standard liquid	0.9978 g/cm <sup>3</sup>
Weighing 1	10.526 g
Weighing 2	2.586 g
Density	1.322776 g/cm <sup>3</sup>

-----  
Signature

## Using header and footer information

### Procedure:

1. Press  Print header> button.
2. Carry out density determination procedure.
  - Report is printed out automatically after the second measurement confirmation.
  - When density determination result is displayed, the report can be printed repeatedly by pressing  **PRINT**> button.
3. Press  Print footer> button upon completion of density determination procedure.

### Caution!

Remember to select data to be printed in the header, footer and report. For detailed information go to section 14.7, Printouts.

## 21. ANIMAL WEIGHING



<  Animal weighing> is a working mode allowing reliable determination of mass of weighed objects in motion. In principle, this type of objects generate unstable measurement, thus it requires using a different filtering method of measurement signal.

### Animal weighing mode screen

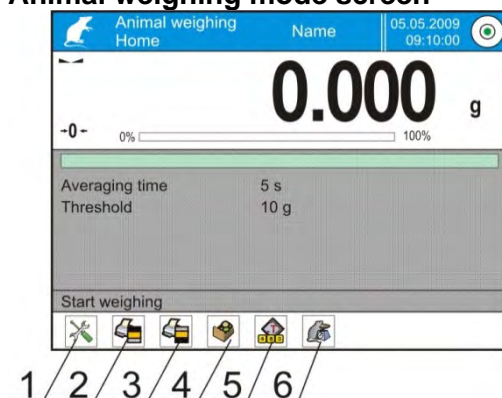

1. Setup – press to access balance menu.
2. Print header – press to print data declared in the header.
3. Print footer – press to print data declared in the footer.
4. Products Database – press to select products from products database.
5. Set tare.
6. Animal weighing.

### 21.1. Animal Weighing Settings

Animal Weighing mode parameters must be set with regard to selected mass analysis method.

### Procedure:

1. Press  Animal weighing> button.
2. List of Animal Weighing parameters is displayed:
  - Averaging time  
Time interval within which measurements are analysed. Obtained data is used for calculation of measurement result.





- Automatic operation  
Parameter determining whether the measurement is to be carried out manually (on pressing a key), or automatically. The measurement starts automatically if indication on balance's display exceeds the value of a set threshold. Measurement of the next object begins after removing one object from the weighing pan (the indication is below threshold value) and loading the pan with the next object at the moment when the indication exceeds the set threshold value.
- Threshold  
Value expressed in mass units. In order to trigger the measurement, the indicated value has to be greater than the threshold value.

3. Set parameters and return to weighing.

4. Load the weighing pan with an object to be weighed, press < > button.

5. "Freezed" measurement result is displayed.

6. In order to proceed to the next measurement press < > button:

- in case of manual operation mode, press < > button.
- in case of automatic operation mode, unload the weighing pan and load it with the new object to be weighed.

## 21.2. Mode Related Settings

To find out more about the remaining functions refer to section 15.7 of this user manual, *Additional Parameters for a Weighing Process*.

## 22. FORMULATIONS



<**Formulations**> is a working mode allowing you to prepare multi-ingredient mixture. The whole process is carried out automatically.

While making mixtures you can:

- use formulations database which stores formulations; the program helps you dispense particular amount of formulation ingredients, this is done by means of respective on-screen messages.
- make mixture on your own, without using formulations database, with this option you control dispensed ingredients, their sequence and quantity by yourself.

If you want to use formulations database, first you have to create recipe (make formulation), next apply it. In order to create recipe you have to enter <Formulations> database. For detailed procedure informing you how to create series, read later sections of this user manual.

### Formulations mode screen

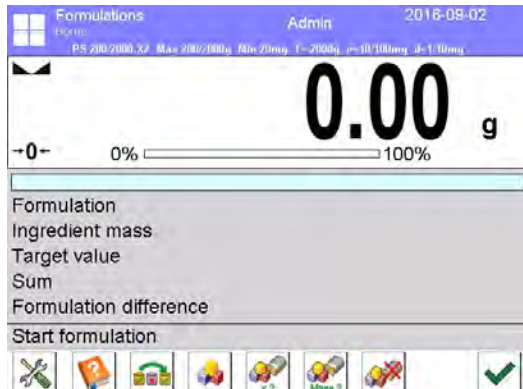

1. Setup – press to access balance menu.
2. Print header.
3. Print footer.
4. Formulation – press to select formulation from the database.
5. Formulation multiplier (formulation activated when <NO> value is set for <Multiplier's editing> parameter).
6. Target mass
7. Formulation using out of database ingredients

## 22.1. Mode Related Settings

The supplementary settings enable you to adjust the working mode to your needs and requirements. To access the settings follow the below procedure.

### Procedure:

1. Press grey workspace area.
2. The following submenus are displayed: Settings, Buttons, Information, Printouts, Profile.
3. Select <Settings> menu.
4. Functions related to formulations are displayed.

### Formulation mode settings:

- Automatic ingredients naming:
  - Yes
  - No
- Apply tare from database:
  - YES - each ingredient has a tare value assigned (the value is assigned on the basis of data for a particular product saved to the products database);
  - NO - tare is not applied.
- Means of ingredient verification:

Use this function to specify how to determine ingredient mass during formulation making process, by TOLERANCE or by THRESHOLDS.

  - TOLERANCE: the software accepts mass of an ingredient as correct if it is within set percent tolerance of total ingredient's mass ( $\pm\%$ ) - (data acquired from database of products).
  - THRESHOLDS: the software accepts mass of an ingredient as correct if it is within set thresholds (data acquired from database of products).  
Specified method is in effect for all ingredients in the formula making process.  
If during formulation making process one of the ingredients is weighed in excess (its mass is out of high tolerance limit) the following message is displayed upon ingredient weight confirmation: <VALUE OUT OF RANGE. RECALCULATE THE FORMULATION?>. Confirm, the software automatically recalculates mass of other ingredients so that the mixture proportions are correct.  
In order to make THRESHOLDS option active, the product/ingredient related data in database must correspond with value selected for <MEANS OF INGREDIENT VERIFICATION> parameter, e.g. ingredient thresholds are specified and <THRESHOLDS> value is set for <MEANS OF INGREDIENT VERIFICATION> parameter, otherwise particular ingredients mass recalculation is not possible, for example when ingredient thresholds are specified and <TOLERANCE> value is set.
- Multiplier's editing:

Function designed to enable making multiple mixtures according to a selected formulation in a single weighing process:

  - YES - on selecting a formulation for processing the software requests for multiplier's value, the provided value is in effect for all ingredients in the formulation making process, i.e. each ingredient is multiplied by the value.
  - NO - multiplier value is disabled, default value is set to <1>.
- Printout; for information on how to operate this function read section 15.7, Additional Parameters for a Weighing Process.



## 22.2. Formulations – Quick Access Buttons

Each working mode features automatically displayed set of default on-screen quick access buttons. The set can be modified, i.e. you can add out-of-list quick access buttons to it. Such operation requires particular permissions level.

### 22.3. Adding Formulation to Formulations Database

Formulation database contains formulations names, ingredients names and their weight. Each product used for formulation making process is saved to the database of products. When preparing a formulation, first name it, next add ingredients. The software is intuitive and you are guided by means of respective messages. Make sure you know complete recipe as it is necessary to specify name and weight of each mixture ingredient. Formulations database menu has been designed to enable adding formulations.

#### Procedure:

1. Enter < Databases> submenu and press < Formulations> button.
2. Press < Add> button, do it to add a new formulation.

A new record is automatically added to the database, it is opened in an editing mode. Enter necessary data.

List of parameters defined for a formulation:

- Name: click name button, new window opens, go to the window and enter formulation name.
- Code: click code button, enter code number.
- Ingredients: click ingredients button, list of formulation ingredients is displayed (for new formulation the list is empty), add the ingredients:
  1. Press < Add> button.
  2. Select one of available options:
    - <New ingredient>** - select to add a new product, first enter name, next specify mass to be weighed during formulation making process. The software automatically adds the products to the products database.  
**Caution!** *In order to enter remaining product data it is necessary to go to product database.*
    - <New ingredient from database>** - select to view a list of database stored products, choose the product you need for your mixture, the software weighs as much product/ingredient as specified by product database mass parameter. Mass value can be edited and modified for each added product. The introduced modifications do not affect mass value saved to the database.
- Ingredients quantity: parameter disabled for editing, updated by the software upon adding of an ingredient to a formulation.
- Sum: target mass of a formulation, i.e. sum of all formulation ingredients, parameter disabled for editing, updated by the software upon adding of an ingredient to a formulation.

### 22.4. Using Formulations in Weighing



Upon running FORMULATIONS mode, you can prepare the mixture either manually or by selecting formulation from the database.

Mixture preparation options:

- formulation not recorded in the Formulation Database – manual preparation,
- formulation recorded in the Formulation Database,
- formulation recorded in the Formulation Database – using multiplier function,
- formulation recorded in the Formulation Database – determining target mass of complete formulation.



#### **Caution!**

*In order to use the above options it is necessary to add respective quick access buttons to the bottom bar and set formulations mode parameters.*

Select a formulation, weigh each of its ingredients. Wait for the indication to stabilize and press < > button. Weight of each ingredient is tared upon pressing < > button; i.e. it is accepted for the total mass of the formulation.

Press  button to cancel all operations regarding formulation making process. Now you can prepare a different formulation.



**Procedure 1** Formulation not recorded in the Formulation Database – manual preparation. Follow the displayed prompts.

1. Go to quick access bar and press  button (Start).
2. Name the formulation.
3. Select ingredients for a formulation.
4. Select the first ingredient (new or from database of products).
5. The home screen is displayed.
6. Put the container used for carrying out the measurement on a weighing pan and tare it when the indication is stable.
7. Dispense specified amount of the ingredient.
8. Press < > button to confirm.
9. Select the next ingredient.
10. Repeat the steps for remaining mixture ingredients.
11. With all the ingredients weighed, select one of the following options:  
<Save and finish> - select to save the process to formulations database, the process is finished automatically, the final report is recorded in formulation database.  
<Finish> - select to complete without saving the process to formulations database the process is finished automatically, the final report is recorded in formulation database.
12. Upon completion, formulation home screen is displayed, message <Completed> is visible in the bottom bar. To proceed press < > button.

**Caution!**

*It is possible to abort formulation making process at any moment. To abort the process press < > button.*



**Procedure 2** Formulation recorded in the Formulation Database. Basic recipe-making process. Procedure 2 allows you to prepare mixture multiplicity easily. Follow the displayed prompts.

1. Press < > button (Formulation).
2. List of Formulations is displayed, select the formulation that is to be carried out.
3. Press < > button (Formulation with multiplier).  
If <Multiplier's editing> option is disabled (set to <NO> value), the software automatically skips to formulation making process. If the <Multiplier's editing> option is enabled (set to <YES> value), the software displays a window with an on-screen keyboard for inserting the multiplier value. Mass of all formulation ingredients is multiplied by the specified value (mass of each ingredient is a product of mass saved to a formulation and multiplier value).
4. Confirm entered multiplier value, formulation making process starts automatically. The following parameters are displayed: selected formulation name, the first ingredient name, ingredient number, mass to be weighed and target mass.
5. Load the weighing pan with a container for a weighed product, wait for a stable measurement indication, tare the balance.
6. Dispense specified amount of the ingredient.
7. Confirm ingredient mass value, the software automatically adds the mass to the sum of weighed formulation ingredients, the next ingredient weighing begins.

8. With all formulation ingredients weighed a report on completed process is printed and saved to reports database (report template is editable, to edit a report template go to <Printouts> parameter), message <Completed> is visible in the bottom bar. To proceed press < > button.

**Procedure 3** Formulation recorded in the Formulation Database – using multiplier function.

This procedure is useful when you need to prepare a mixture of mass different from the total mass (previously saved to database) of used ingredients. In such case, there is no need for you to carry out complex calculations of ingredients' mass. The software adjusts mass of each ingredient in relation to pre-defined target mass of the complete formulation. Follow the displayed prompts.

1. Press < > button (Formulation).
2. List of Formulations is displayed, select the formulation that is to be carried out.
3. Press < > button (Formulation with target mass).
4. Window with an on-screen keyboard for entering target mass of a mixture is displayed.
5. Confirm entered multiplier value, formulation making process starts automatically . The following parameters are displayed: selected formulation name, the first ingredient name, ingredient number, mass to be weighed and target mass. Mass of each ingredient is automatically recalculated (proportionally) to the value of defined target mass of the complete formulation.
6. Put the container used for carrying out the measurement on a weighing pan and tare the indication when it is stable.
7. Dispense specified amount of the ingredient.
8. Confirm ingredient mass value, the software automatically adds the mass to the sum of weighed formulation ingredients, the next ingredient weighing begins.
9. With all formulation ingredients weighed a report on completed process is printed and saved to reports database (report template is editable, to edit a report template go to <Printouts> parameter), message <Completed> is visible in the bottom bar. To proceed press < > button.

In order to print report on completed formulation making processes enter Formulation Reports Database.

## 22.5. Printouts

Printouts option enables you to determine content of a particular standard printout, and to define non-standard printout.

Standard printout comprises four internal blocks, each containing different variables. Variable settings: YES – print; NO – do not print.

Settings for header, GLP, and footer printouts are specified in section 14.7. For settings of formulation report read below. You can design report content.

**Caution!**

*In order to specify which measurement data is to be printed on a report it is necessary to modify settings for <Weighing printout template> parameter. To enable particular measurement data printout, set it to <YES> value. Upon each completed formulation process the program generates a report. The report is*

*recorded in < Formulation reports> database. Report files are named by date and time of formulation process performance.*

### Report content:

- Working mode
- Operator
- Customer
- Warehouse
- Formulation
- Formulation code
- Start date
- End date
- Ingredients quantity
- Measurements quantity
- Measurements
- Target value
- Sum
- Formulation difference
- Status
- Empty line
- Dashes
- Signature
- Non-standard printout

### Example of a report

```
----- Formulation Report -----
Operator                Nowak Jan
Formulation name        Mixture 1

Start date              2011.12.16 13:21:40
End date                2011.12.16 13:22:28

Ingredients quantity    5
Completed measurements quantity 5

----- Measurement 1 -----
19.994 g
----- Measurement 2 -----
49.993 g
----- Measurement 3 -----
9.999 g
----- Measurement 4 -----
1.001 g
----- Measurement 5 -----
19.995 g

Total mass              100.982
Target mass             101.000
Difference               -0.018



Status                  OK
-----
Signature
.....
```

## 23. STATISTICS



<  Statistics > is a working mode allowing to acquire data from series of measurements and to produce statistics using the acquired data. Settings of this function determine which data is displayed.

### Mode activation procedure:

1. Go to the home screen, press  pictogram located in the top bar.
2. <Working modes> submenu is opened, it contains list of working modes to be selected.
3. Select <  Statistics >.
4. The home screen is displayed automatically, wherein the top bar of the screen features  pictogram.

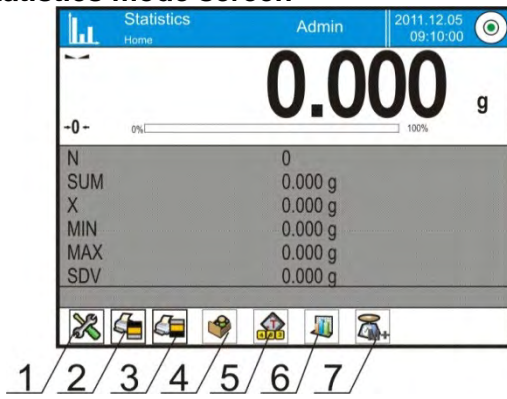

## Statistics mode screen



1. Setup – press to access balance menu.
2. Print header – press to print data declared in the header.
3. Print footer – press to print data declared in the footer.
4. Products Database – press to select products from products database.
5. Set tare.
6. Statistics
7. Add to statistics.

### 23.1. Buttons and Information Settings

Buttons crucial for series of measurement:

- <  PRINT> - press to trigger printout and to add measurement to statistics,
- <  M+ Add to statistics> - press to add measurement to statistics, printout is not triggered.

You can define your own set of default keys and information that is to be displayed in Info field.

### 23.2. Additional Settings for Statistics

To find out more about the remaining functions refer to section 15.7 of this user manual, Additional Parameters for a Weighing Process.

### 23.3. Measurement Series Parameters

For each series of measurements it is possible to overview the results, print a report, delete results of all statistics.

**Procedure:**

1. Press <  button (Statistics).

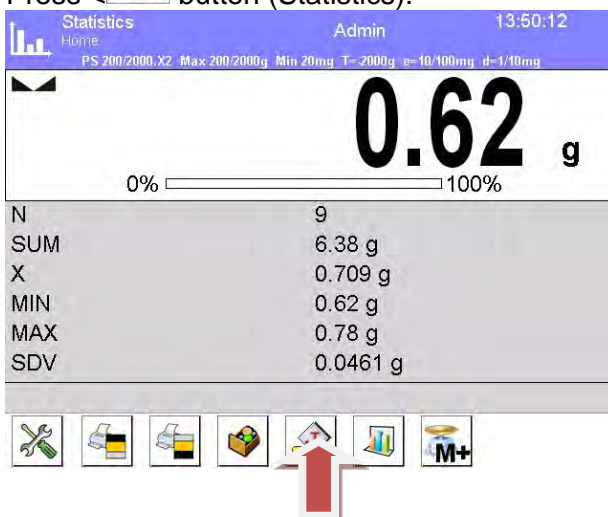

2. The following options are displayed: Result, Print, Delete last, Delete, Measurements graph, Probability distribution graph.
3. Select one of available options:  
**Result** – to preview statistics report,  
**Print** – to print a report,



## Example of a report

----- Statistics -----	
N	9
SUM	455.600 g
X	50.6222 g
MIN	49.939 g
MAX	51.380 g
D	1.441 g
SDV	0.39605 g
RDV	0.78 %

**Delete last** – to cancel the last measurement,

**Delete** – to remove all statistics data,

**Measurements graph** – to make the software generate and display a graph with distribution of measurements in mass/measurement coordinates system for completed measurement series (see the graph below).

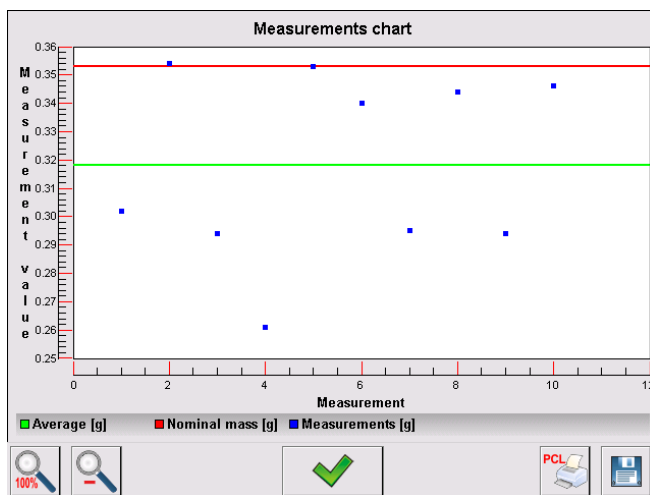

**Probability distribution graph** – to make the software generate and display a graph of probability distribution for completed measurement series. (see the graph below). The bar graph demonstrates number of identical results in a series.

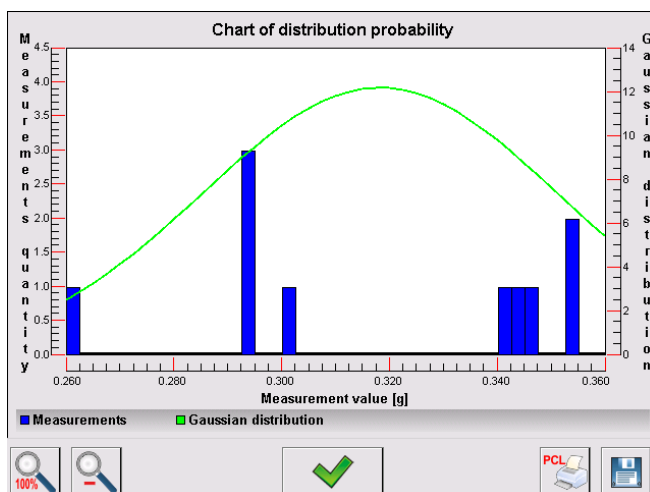

Bottom bar tools:



Press to display complete graph.

Press to zoom out the screen content.

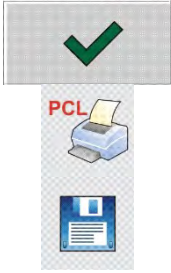

Press to go back to the previous window.

Press to print the graph using PCL printer.

Press to save the graph as \*.bmp file to USB flash drive connected to USB port.

## 24. PIPETTES CALIBRATION

Balance enables pipettes calibration using dedicated program function or PIPETTES PC software (workstation for pipettes calibration). Prior to calibration start it is necessary to install pipettes calibration set inside the anti-draft chamber. The set does not come standard with the balance.

MYA 4Y balance with a set for pipettes calibration.

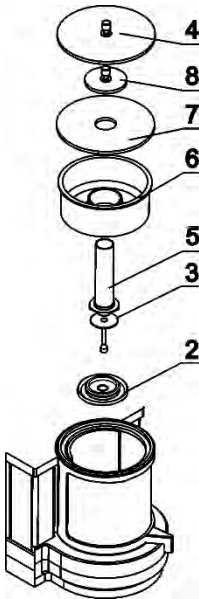

Installation procedure:

1. disassemble the standard weighing pan and the anti-draft shields,
2. inside the chamber install:
  - draft shield (2),
  - weighing pan (3),
  - glass vessel (5),
  - evaporation ring (6),
  - glass lid (7),
  - supplementary lid (8), or
  - glass lid (4).

XA 4Y balance with a set for pipettes calibration:

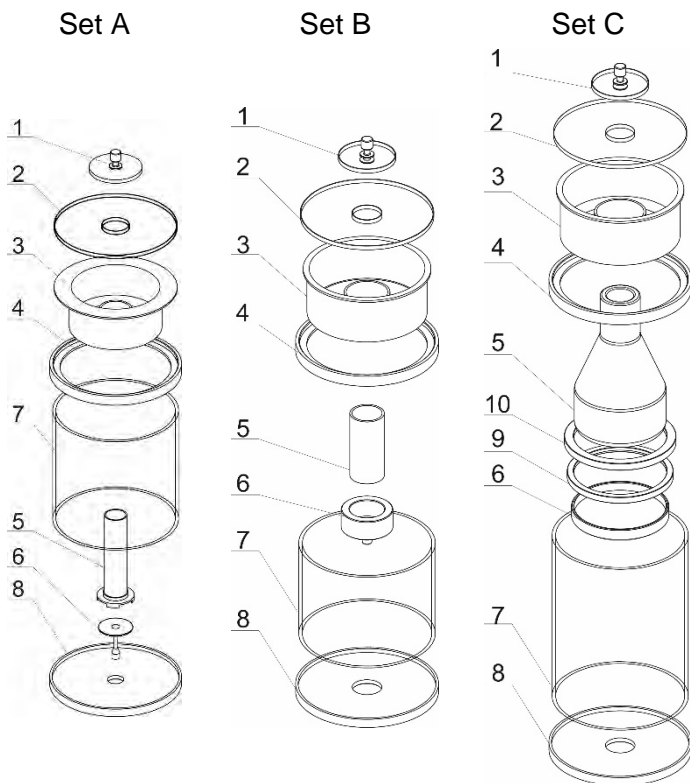

Installation procedure:

1. disassemble the standard weighing pan and the anti-draft shield,
2. place centering ring (8) inside the chamber,
3. put glass ring (7) onto the centering ring,
4. place weighing pan (6) inside the glass ring,
5. inside, place pipette calibration vessel (5), put it onto the weighing pan,
6. if the vessel, used in set C, is too light, it is necessary to apply load ring (9) or (10) onto the weighing pan,
7. put top ring (4) onto the glass ring,
8. put evaporation ring (3) onto the top ring,
9. put glass lid (2) onto the top ring,
10. put glass lid (1) onto the glass lid.

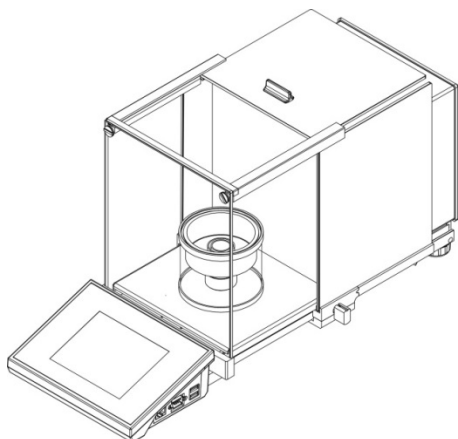

Balance with pipette calibration set installed.

XA 4Y.MA balance can be equipped with a chamber for pipettes calibration featuring automatically opened lid.

Prior operation, install the chamber. Take it out of the packaging and prepare it for assembly. Follow the diagram.

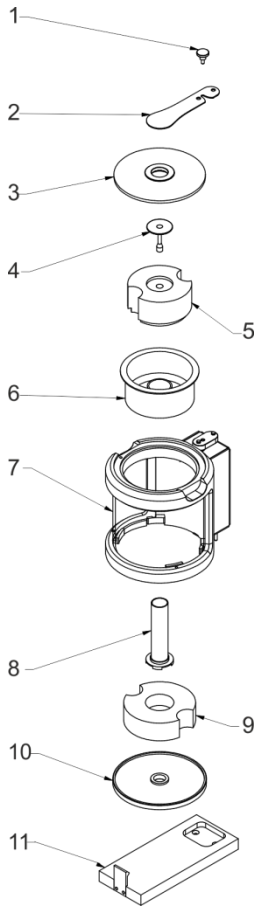

Procedure:

1. Undo protecting screw (1)
2. Remove clamp (2)
3. Remove glass lid (3)
4. Remove the weighing pan (4)
5. Remove protective polyethylene foam insert (5)
6. Remove evaporation ring (6)
7. Disassemble base (11)
8. Remove bottom ring (10)
9. Remove bottom protective polyethylene foam insert (9)
10. Remove glass vessel (8)

Prior installation of the chamber, disassemble glass draft shield, the panes and top frame. Disassembly procedure is described in 'Maintenance Activities' section. Now you can assemble the chamber for pipettes calibration.

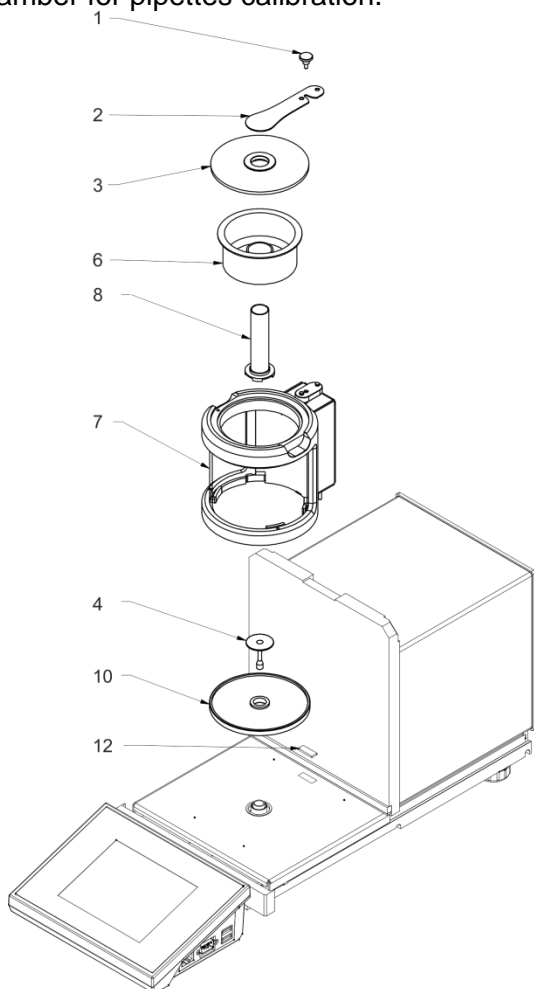

**Procedure:**

1. Disassemble chamber seat protection (12)
2. Install the bottom ring (10)
3. Install the weighing pan (4)
4. Carefully apply the glass chamber connecting it to the connector located in the balance base (7)
5. Install the glass vessel (8)
6. Install the evaporation ring (6), fill it with distilled water
7. Apply glass lid (3)
8. Apply clamp (2)
9. Tighten protecting screw (1)

**Caution!** Be careful so as not to cause any damages to the balance mechanism.

Evaporation ring minimizes measurement errors being a result of liquid evaporation occurring in the course of the weighing process.

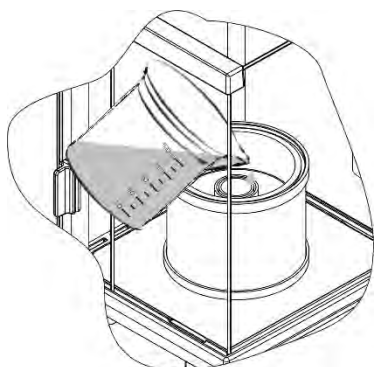

Prior pipettes calibration, distilled water must be poured into the evaporation ring, the amount of water cannot exceed 2/3 of the ring height. The set may be operated after about an hour – this period of time is required for humidity stabilisation. Remember to control the level of distilled water – surface of the vessel has to remain covered with it. Excess of water may be removed by means of an automatic aspirator or an external pipette.

In order to minimize both changes of moisture content inside the weighing chamber and negative effect of air blows during opening of the chamber door, the liquid has to be dosed by means of pipette through an opening located in the top cover/lid of the weighing chamber. In the course of calibration it is allowed to use a balance without an anti-draft chamber. This requires disassembly of the panes and top frame (XA 4Y.A series balances). For panes disassembly instruction read *MAINTENANCE ACTIVITIES* section, for frame disassembly read below. In order to remove frame,

undo 4 screws fixing it to the housing (see the figure). Now you can install pipette calibration set, follow the above instruction.

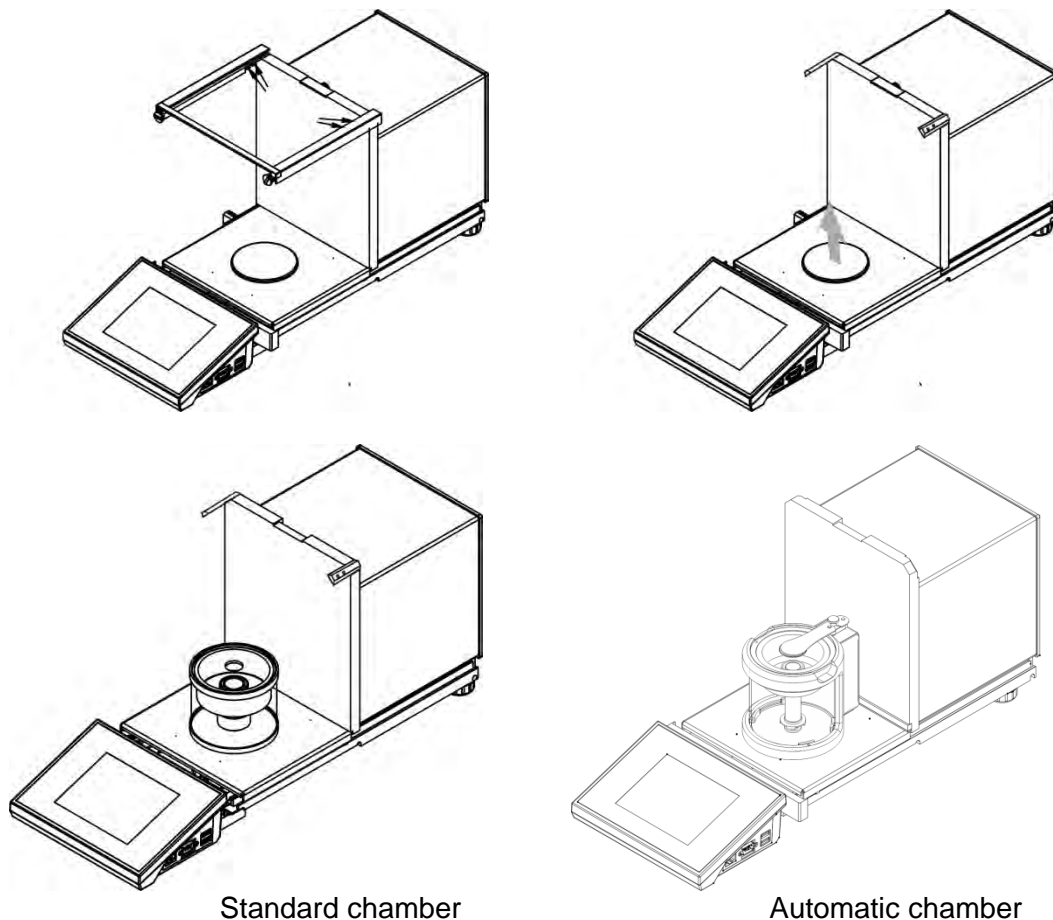

Balance with disassembled anti-draft chamber and with installed calibration set.

Now pipettes calibration can be carried out.



< Pipettes calibration > is a working mode allowing you to determine errors of measurement of piston pipettes volume. The errors can be determined either with reference to ISO 8655 standard or your own requirements.

In case of calibration carried out with reference to ISO 8655 standard, the errors are automatically selected for particular volume, as specified in the standard (refer to: table of errors, ISO 8655 standard).

Pipette calibration mode enables:

- calibrating pipettes of fixed-volume or variable-volume, and single- or multi- channel pipettes.
- creating pipettes database providing the following information: pipette name, code, tested volume, etc.,
- calculating results on the basis of:
  - average volume of a pipette (channel),
  - systematic error  $e_s$  (accuracy error),
  - random error CV (repeatability error),
- carrying out automated measuring procedures conditioned by pipette's type,
- storing calibration results in a database (in a form of reports on calibration process),
- printing reports on pipettes calibration processes,
- exporting test reports.

During the procedure, accuracy and repeatability errors are determined for the tested volume. In case of pipettes with adjustable volume, the software enables declaring up to 5 volume values (from total pipette's range) that are to be checked during calibration process.

**Use only distilled water for pipettes calibration.**

**Ambient conditions crucial for high accuracy calibration:**

- The ambient temperature of the pipette, tip and liquid:
- 20°C ÷ 25°C, during weighing it must be stabilized within ± 0.5.°C
- Relative humidity: 50 ÷ 75%.
- Pipette, tips and distilled water have to be subjected to temperature stabilization carried out directly in the weighing room. The standard recommends the acclimatization for at least 2 hours.

While calibrating pipettes **use pipettes database** providing you with pipette related data, parameters, tested volume, and error values determined for specific volumes.

Prior pipette calibration process, enter pipettes database and provide pipette-related data and calibration criteria. In order to add pipette it is necessary to enter the database. For information on how to add pipette to pipettes database read down this user manual.

**Pipettes Calibration mode screen**

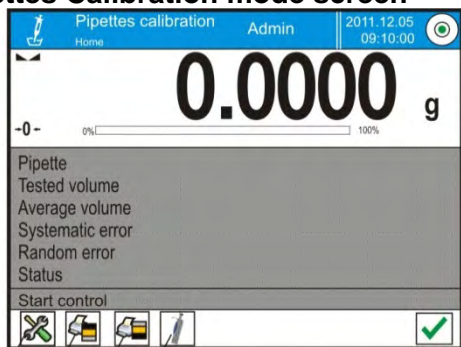

1. Setup – press to access balance menu.
2. Print header.
3. Print footer.
4. Select pipette.

**24.1. Mode Related Settings**

The supplementary settings enable you to adjust the working mode to your needs and requirements. To access the settings follow the below procedure.

**Procedure:**

1. Press grey workspace area.
2. The following submenus are displayed: Settings, Buttons, Information, Printouts, Profile.
3. Select <Settings> menu.
4. The display indicates functions related to pipette calibration process.

**Pipettes Calibration mode settings:**

- **Measurements quantity:** designed to enable determining measurements quantity for tested pipette volume (valid for each tested volume in case of a pipette with adjustable volume),
- **Request serial number:** YES/NO. YES – a window with an on-screen keyboard is displayed, use it to enter serial number of a pipette.
- **Operation with adherence to ISO 8655:** YES/NO. YES – the software automatically takes error values accordant with recommendations of ISO 8655 standard (if other error values have been defined for a particular pipette, then on selecting <Operation with adherence to ISO 8655> parameter the specified error values are neglected and replaced by those from ISO standard).
- **Upload ambient conditions parameters from THB module:** YES/NO. YES – the software automatically acquires and saves ambient conditions' parameters from a connected THB sensor at a right time. NO – you have to read ambient conditions (i.e. temperature, humidity





and pressure) from external sensors and enter them manually both before and after calibration.

- **Result control, Tare mode, Automatic footer printout, Printout mode, Printout:** for information on how to operate these functions read section 15.7.

## 24.2. Pipettes Calibration – Quick Access Buttons

Each working mode features automatically displayed set of default on-screen quick access buttons. The set can be modified, i.e. you can add out-of-list quick access buttons to it. Such operation requires particular permissions level.

While using automatic chamber for pipettes calibration you can control the opening for liquid dosing, this is done either via quick access buttons or proximity sensors:



	Change opening position.
	Uncover the opening.
	Cover the opening.

## 24.3. Adding a Pipette to Pipettes Database

Database of pipettes contains list of pipettes' names and other data, including tested volumes and error values for a specific volume. When adding a pipette to the database, first specify its name, and then add remaining data.

The software is intuitive and you are guided by means of respective messages. Pipettes database menu has been designed to enable adding formulations.

### Procedure:

1. Enter < Databases> submenu and press < Pipettes> button.

2. Press < Add> button to add a new pipette.

A new record is automatically added to the database, it is opened in an editing mode. Enter respective data.

List of parameters defined for a pipette:

- Name: press to enter pipette name.
- Code: press to enter pipette code.
- Model: press to enter model name.
- Tip: press to enter tip name
- Volume type: ADJUSTABLE/FIXED.
- Nominal volume: pipette's nominal volume value.
- Minimum volume: pipette's minimum volume value, for fixed volume pipette enter <0>;
- Channels quantity: specify number of pipette's channels, for a single channel pipette enter <1>;
- Type: NONE/A/D1/D2. Pipette type adheres to standard guidelines. In case of calibration carried out with reference to ISO 8655 standard the errors are automatically selected for particular volume. Determining pipette type is crucial.
- Tested volumes: press "Tested volumes" field, a window with a list of calibrated volumes opens (in case of a new pipette the list is empty), add volume to be tested, and define error value for each tested volume:

Procedure:

1. Press < Add> button.
2. An on-screen keyboard is displayed.

3. Enter tested volume value in [µl] and press <  > button to confirm,
4. A new record is automatically added, the record features recommended error values. In order to change error values press a field with pipette volume (each field can be edited, you can enter error values of your choice).

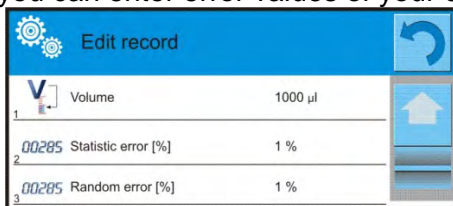

**Caution!** During calibration, the order of tested volumes corresponds to the order in which they are entered.

5. Upon setting correct values return to the home screen.

## 24.4. Printouts

Printouts option enables you to determine content of a particular standard printout, and to define non-standard printout.

Standard printout comprises four internal blocks, each containing different variables. Variable settings: YES – print; NO – do not print..

Settings for header, GLP, and footer printouts are specified in section 14.7. For settings of pipettes calibration report read below.

### Report content:

- Working mode
- Operator
- Customer
- Pipette
- Serial no.
- Channels quantity
- Channel no.
- Measurements quantity
- Cooperation in accordance with ISO 8655
- Start date
- End date
- Dashes
- Signature
- Non-standard printout
- Water temperature
- Temperature
- Humidity
- Pressure
- Z coefficient
- Measurements and statistics
- Statistics
- Status
- Empty line

## 24.5. Pipettes Calibration Start-Up

In order to carry out pipettes calibration process you need a special adapter, the adapter does not come standard with the balance.

The adapter facilitates piston pipettes calibration and/or verification, it is intended for 3Y and 4Y balances.

The adapter has been designed to minimize evaporation occurring in the course of liquids weighing. It comprises a mini weighing chamber, installed inside the weighing chamber of a balance, an evaporation ring, and a dedicated weighing pan, enabling to locate a measuring vessel in the very centre

Application of the adapter prevents risk of liquid evaporation during the calibration process. Compact dimensions of the adapter along with use of the evaporation ring enable maintaining high humidity rate inside the weighing chamber.

Carried out research has proved that the adapter eliminates or considerably reduces liquid evaporation process. Eliminated/reduced liquid evaporation is a key factor while calibrating piston pipettes by means of a gravimetric method.

Selecting an appropriate adapter and balance is conditioned by calibrated pipettes type.

Prior pipettes calibration start, install the adapter inside of the weighing chamber, next enter data regarding pipettes that are to be calibrated, include complete pipette characteristics and values of errors (see: Pipettes Database).







Now set pipettes calibration parameters:

- Measurements quantity
- Request serial number (YES/NO).
- Operation with adherence to ISO 8655 (YES/NO).
- Upload ambient conditions parameters from THB module (YES/NO).

**Caution!** For parameters and settings overview read section 24.1 of this user manual.

With all parameters set, you can start pipettes calibration.

### Pipettes calibration procedure:

1. Press < Select pipette> button.
2. List of pipettes is displayed, select pipette to be calibrated.
3. Pipettes calibration home screen is displayed, selected pipette name is visible in Info field.
4. Press < START> button.
5. With <YES> value set for <Request serial number> parameter, a window for entering the number opens. Enter the value and confirm.
6. Window for entering ambient conditions values is displayed, read the temperature, humidity and pressure from external sensors and enter them, next press < > button.  
With <YES> value set for <Upload ambient conditions parameters from THB module> parameter, the temperature, humidity and pressure values are acquired automatically from the THB module, water temperature must be entered manually, enter it and press < > button to confirm.
7. Pipettes calibration home screen is displayed, tested volume and process status <In progress> are displayed in Info field. The task bar displays prompts guiding you through the process - <C1/V1/N1 Sample weighing>. Where: C1 – channel number; V1 – volume number for the channel; N1 – measurement number for tested volume.
8. Keep following the prompts until the calibration process is completed. Info field provides you with information on the on-going process (average volume, error values).
9. Upon confirmation of the last measurement, a window with ambient conditions parameters is displayed again. Enter the parameters and press < > button to confirm.
10. A report is generated automatically, the report is printed and recorded in pipettes calibration reports database (ambient conditions and water temperature values given on a report are average values from the process);
11. Press < > button located in the bottom bar. For multichannel pipette you are asked whether the process shall be continued for remaining channels. Upon confirmation the balance carries out calibration process for the following channels. The settings remain unchanged.
12. You can start the following procedure for the same pipette or select another pipette form pipettes database.

### 24.6. Performed Pipettes Calibrations Report

Upon completed calibration process a report is generated. The report is saved to the < **Pipette calibration reports**> database. The files are named by date and time (hour) of calibration process performance.

**Example of a report:**

----- Pipette Calibration -----

User	Smith
Customer	Williams
Pipette	p901\1k
Serial no.	7777
Channels quantity	1
Channel no.	1
Measurements quantity	10
Operation with adherence to ISO 8655	Yes
Start date	2015.11.15 07:50:44
End date	2015.11.15 07:54:34
Water temperature	22.15°C
Temperature	21°C
Humidity	48%
Pressure	1005 hPa
Z coefficient	1.00328

----- Tested Volume: 1000 µl -----

1	0.998 g	1000.82389 µl
2	0.998 g	1000.82389 µl
3	0.998 g	1000.82389 µl
4	0.998 g	1000.82389 µl
5	0.998 g	1000.82389 µl
6	0.998 g	1000.82389 µl
7	0.998 g	1000.82389 µl
8	0.998 g	1000.82389 µl
9	0.998 g	1000.82389 µl
10	0.998 g	1000.82389 µl

Average volume	1000.82389 µl
Average [%]	100.08 %
Systematic error	0.82389 µl
Systematic error [5]	0.08239 %
Permissible error	± 16 µl
Random error	0 µl
Random error [%]	0 %
Permissible error	± 6 µl
Status	Positive

-----  
Signature

## 25. DIFFERENTIAL WEIGHING

<  **Differential weighing** > is a working mode enabling you to analyse changes of mass of a single sample or multiple samples.

The process is carried out by determining sample's initial mass, next the sample is subjected to different processes, as a result some sample's ingredients are either separated or added. Finally, the sample is repeatedly weighed (differential weighing). After the final weighing, the balance determines the difference between those two mass values (initial and final).

Differential weighing mode allows you to:

- Determine **a series**, each series may contain several samples.
- Assign a name for each series, print or export data on a series to a connected USB flash drive;
- For each sample: determine tare value, initial mass and carry out up to five measurements for the final mass.

In order to operate differential weighing mode, first it is necessary to enter weighing series to the database, define samples in the series, next trigger the series. To create series go to series database. For detailed procedure informing you how to create series, read later sections of this user manual.

### Differential Weighing mode screen



1. Setup – press to access balance menu.
2. Series
3. Sample
4. Weighing A
5. Weighing B
6. Weighing T+A
7. Delete value

### 25.1. Mode Related Settings

The supplementary settings enable you to adjust the working mode to your needs and requirements. To access the settings follow the below procedure.

#### Procedure:

1. Press grey workspace area.
2. The following submenus are displayed: Settings, Buttons, Information, Printouts, Series, Profile.
3. Select <Settings> menu.
4. Functions related to differential weighing are displayed.

#### Differential Weighing mode settings:

- **Threshold:** mass value (maximum mass of a sample, e.g. filter)
- **Ambient conditions:** use this function to force operator to enter temperature and humidity prior to weighing operation: <Weighing A, Weighing T+A, Taring T>
  - NO - value not required
  - ONLINE – values taken from ambient conditions module cooperating with the balance.
  - VALUE – values taken from device other than ambient conditions module, must be entered manually.
- **Maximum quantity of weighings:** use this function to declare how many times final weighing <B> is to be repeated – 5 times maximum, the parameter setting is valid for all measuring series.

For information on how to operate remaining functions read section 15.7, *Additional Parameters for a Weighing Process*.

## 25.2. Differential Weighing - Quick Access Buttons

Each working mode features automatically displayed set of default on-screen quick access buttons. The set can be modified, i.e. you can add out-of-list quick access buttons to it. Such operation requires particular permissions level.

This section presents only those buttons that are characteristic for *Differential Weighing* mode.



### Weighing A

Press to start weighing initial mass <A>. The process is carried out as a separate operation.



### Weighing (T+A)

Press to start sample container taring which is next followed automatically by sample weighing (non-separable operations). Upon initiation you are asked to set sample's name.



### Tare (T)

Press to start sample container taring. The process is carried out as a separate operation. Upon initiation you are asked to set sample's name.



### Weighing B

Press to start weighing final mass <B>. The button triggers differential weighing mode

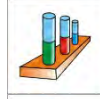

### Series

Press to select a sample for which the differential weighing process is to be carried out.

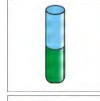

### Sample

Press to select a sample for currently carried out process of a particular series.

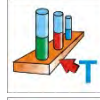

### Copy Tare

Press to copy tare value, determined for a given sample, to all current series samples (for which the tare value has not been assigned yet).



### Deleting Value

Press to delete the most recently recorded mass value (tare, weighing A or weighing B).

and

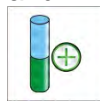

### Add sample

Press to add a new sample, window with an on-screen keyboard is displayed, use it to provide the new sample name. In order to add a new sample first it is necessary to select series for which the sample is to be added. Mind not to start weighing operation before selecting the series and adding the sample.

## 25.3. Adding Series to Series Database

Series Database comprises series and series samples.

While creating a series, first set its name, next add samples. The software is intuitive and you are guided by means of respective messages. Provide a name for each sample. To add a series go either to series database or differential weighing mode.

### Procedure:

1. Enter < Database> submenu and press <Series> button.

2. Press < Add> button, a series is added.

A new record is automatically added to the database, it is opened in an editing mode. Enter the necessary parameters.

List of parameters defined for series:

- Name: press “Name” field, a window for entering series name opens.
- Code: enter series code.
- Customer: select a customer for whom the series measurements are to be carried out.
- Samples: press to view list of samples, for a new series the list is empty, add new samples.
- to do it press <  Add > button, the sample is added automatically, its name can be edited and changed.
- Samples quantity – parameter disabled for editing, the number is updated at real time by the software on adding a new sample to the series.

For each sample on the list, its current differential weighing status is displayed (weighing process stage).

Newly added samples do not have any status assigned – the field is empty. The status is updated at real time after each completed weighing process stage.

## 25.4. Differential Weighing Process Example

Activate *Differential Weighing* mode, next:

1. Select information to be displayed in the grey workspace.
2. Select appropriate quick access buttons.
3. Add a series to balance’s memory (series is identified by name).
4. Add samples to a series (sample is identified by name).
5. Return to the differential weighing home screen.

### Selecting a series:

Press <SERIES> quick access button, a window with series database opens.

Enter the database, press field with series that is to be carried out.

Selected series name is displayed in the grey workspace (provided that such information is enabled to be displayed).

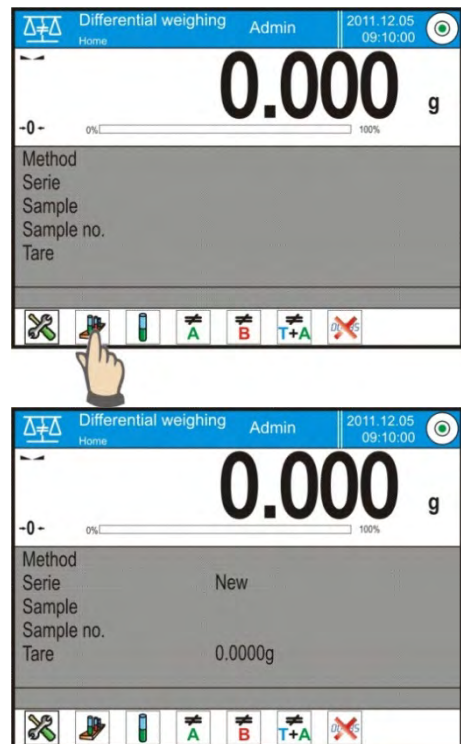

Upon selecting a series, press one of the following buttons determining how the differential weighing is to be carried out:



### Weighing A

Press to start weighing initial mass.

### Tare (T)

Press to start sample container taring.





### Weighing (T+A)

Press to start sample container taring which is next followed automatically by sample weighing (non-separable operations).



### Weighing B

Press to start weighing final mass. The button is enabled only for a series containing samples for which weighing A has been carried out. If there are no such samples, the operation is disabled.

## Weighing A

- Upon pressing Weighing A button, the balance searches samples list in order to find the first sample for which weighing <A> is still to be carried out. If there are no such samples the balance displays a message informing you that the operation is disabled.
- 
- If the operation is enabled then new data on initiated process is displayed in the grey workspace.
- You are guided through the process by means of prompts visible either in the workspace or bottom bar.
- 
- Load the weighing pan with a sample and press <  > button.
- For <Ambient condition> parameter set to <Value> option, a window for entering temperature and humidity values is displayed. For <Ambient condition> parameter set to <ONLINE> option, a window for confirmation of values taken from ambient conditions module is displayed.

**Caution!** If <Ambient conditions> parameter for the differential weighing mode is set to <No> value, the software skips this part of the process.



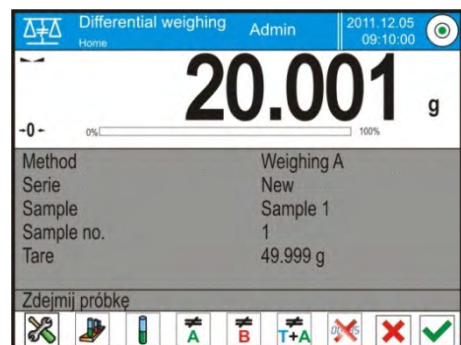
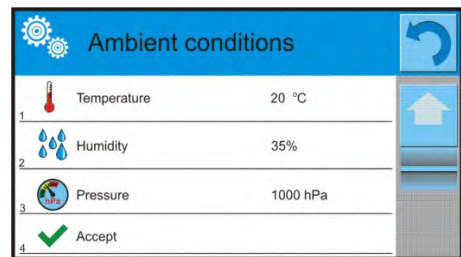
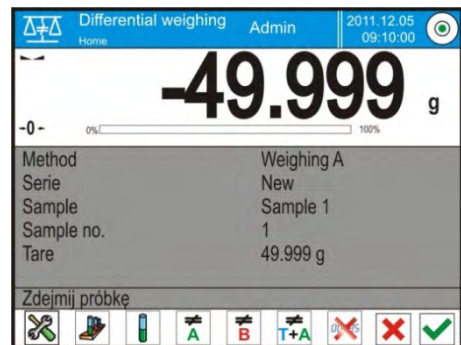
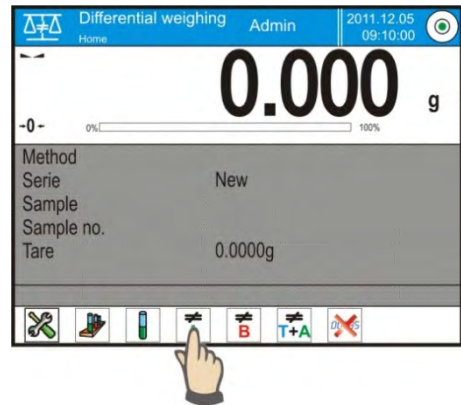

- Press <  > button to confirm ambient conditions values, differential weighing home screen is displayed, you are prompted to unload the weighing pan.

- Unload the weighing pan and press <  > button. The balance searches samples list again in order to find the first sample for which weighing <A> is still to be carried out. Follow the above procedure and carry out weighing of the remaining samples.





- In order to abort the process press <  > button.



### Weighing T

- Upon pressing Weighing T button, the balance searches samples list in order to find the first sample for which weighing <T> is still to be carried out. If there are no such samples the balance displays a message informing you that the operation is disabled.
- If the operation is enabled then new data on initiated process is displayed in the grey workspace.
- You are guided through the process by means of prompts visible either in the workspace or bottom bar.
- Load the weighing pan with a sample container and press <  > button.
- Upon pressing <  > button you are prompted to unload the weighing pan.
- Unload the weighing pan and press <  > button. The balance searches samples list again in order to find the next sample for which weighing <T> is still to be carried out. Follow the above procedure and weigh the remaining containers.
- In order to abort the process press <  > button.

### Weighing T+A

- Upon pressing Weighing T button, the balance searches samples list in order to find the first sample for which weighing <T> is still to be carried out. If there are no such samples the balance displays a message informing you that the operation is disabled.
- If the operation is enabled then new data on initiated process is displayed in the grey workspace. You are guided through the process by means of prompts visible either in the workspace or bottom bar.
- Load the weighing pan with a sample container and press <  > button.
- Container mass value is assigned to a sample as tare value, balance indication is zeroed, and you are prompted to place the sample in the container. Follow the prompt and press <  > button. For <Ambient condition> parameter set to <Value> option, a window for entering temperature and humidity values is displayed. For <Ambient condition> parameter set to <Online> option, a window for confirmation of values taken from ambient conditions module is displayed.

**Caution!** If <Ambient conditions> parameter for the differential weighing mode is set to <No> value, the software skips this part of the process.

- Press <  > button to confirm ambient conditions values, differential weighing home screen is displayed, you are prompted to unload the weighing pan.
- Unload the weighing pan and press <  > button. The balance searches samples list again in order to find the first sample for which weighing <A> is still to be carried out. Follow the above procedure and carry out weighing of the remaining samples.
- In order to abort the process press <  > button.

Measurement of series samples can be carried under the following procedures: weighing A, weighing T or weighing T+A. Each of the series samples features status informing you on a process stage for a given sample. Upon entering the series database and selecting a particular series for preview you are provided with list of samples recorded for the series.

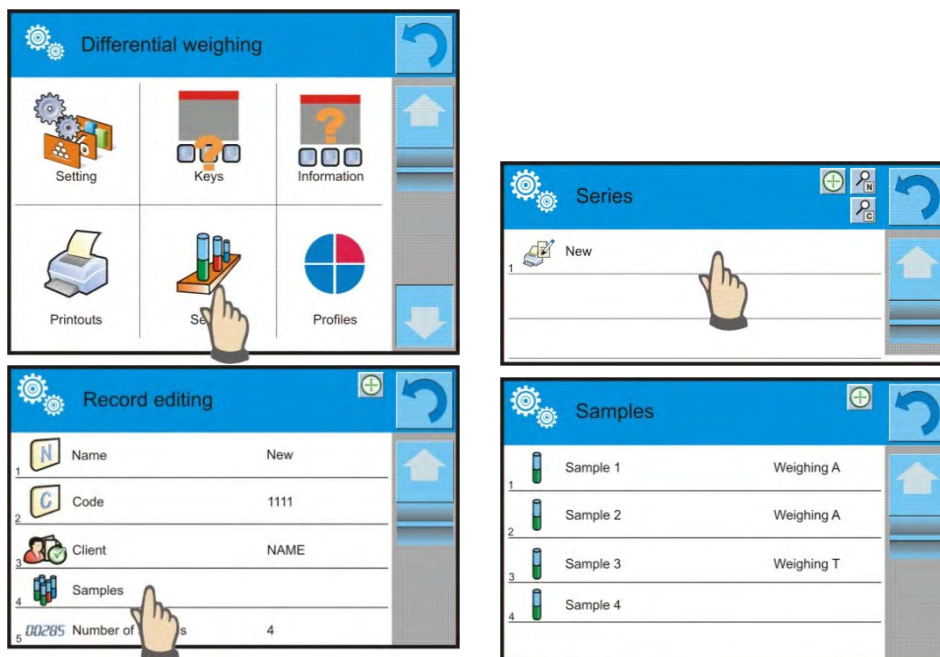

Status overview:

- weighing A, measurements completed for <Weighing A> or <Weighing T+A> procedure,
- weighing T, measurements completed for <Weighing T> procedure.

In order to preview detailed information on a sample, press field with its name. Sample window contains the following data:

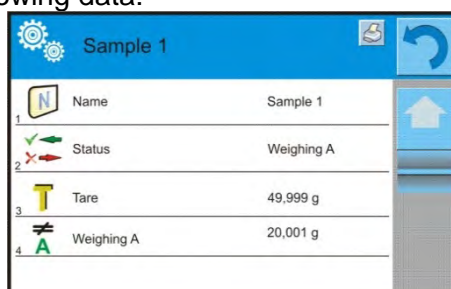

For sample measured under:

- weighing A procedure only – tare value is <0>,
- weighing T procedure only – weighing A value is <0>,
- weighing T+A procedure – tare and weighing A values is mass.

You can print weighed sample data, to do it press a printer pictogram located in the top bar. In order to preview data on weighing A, press <Weighing A> field:

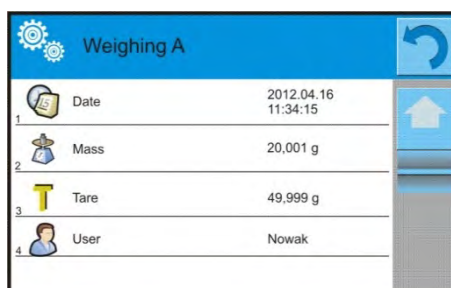

If a given series already contains samples for which weighing A (initial mass) has been carried out you can proceed to carrying out weighing B (final mass).

## Weighing B

- Upon pressing Weighing B button, the balance searches samples list in order to find the first sample for which weighing <B> is still to be carried out. If there are no such samples the balance displays a message informing you that the operation is disabled. If the operation is enabled then new data on initiated process is displayed in the grey workspace.



**Caution!** Next to <Weighing B> caption you can see digits 1/3 where <1> means the first measuring cycle of type B, and <3> means that <Repetitions Quantity> parameter is set to <3> value (3 cycles).

The software prompts you to carry out the <First> cycle, out of <3> cycles, for all samples in the series for which the measurement is enabled (it is required that weighing A is already completed for the sample).

- You are guided through the process by means of prompts visible either in the workspace or bottom bar.
- If tare is assigned to a sample, then its value is displayed with '-' sign. Load the weighing

pan with a sample (if tare is assigned load the sample in a container) and press . For <Ambient conditions> parameter set to <Value> option, a window for entering temperature and humidity values is displayed. For <Ambient condition> parameter set to <Online> option, a window for confirmation of values taken from ambient conditions module is displayed.

**Caution!** If <Ambient conditions> parameter for the differential weighing mode is set to <No> value the software skips this part of the process.

- Press  button to confirm ambient conditions values, differential weighing home screen is displayed, you are prompted to unload the weighing pan.
- Unload the weighing pan and press  button. The balance searches samples list again in order to find the first sample for which weighing <B> is still to be carried out. Follow the above procedure and carry out weighing of the remaining samples.
- In order to abort the process press  button.

Upon completing measurements of final mass for the samples in a series, you can check the results in the series database. To check the results, enter the database, select a series, then select samples and a specific sample for which <Weighing B> has been carried out.

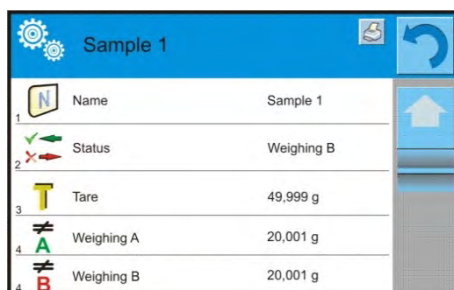

Sample 1		
1	Name	Sample 1
2	Status	Weighing B
3	Tare	49,999 g
4	Weighing A	20,001 g
4	Weighing B	20,001 g

Particular weighing's preview mode provides you with values. Numbers referring to weighing <B> inform on the measuring cycle.

Data on a specific series can be printed or exported to a file.

### 25.5. Copy Tare

Copy Tare option enables copying once selected tare value (in a series) to all samples which do not have tare value assigned, and for which differential weighing process (status other than Weighing B) has not been completed.

### Procedure:



1. Press <T> button.
2. List of samples with tare values assigned is displayed.
3. Press tare value that is to be applied to other samples which do not have tare assigned yet.
4. The selected tare value is assigned automatically.

Samples		
1	Sample 2	49.999 g
2	Sample 3	15.256 g

### 25.6. Sample Selection

Sample Selection option enables selecting a sample for weighing, with use of this option you do not have to weigh samples in an order suggested by the software. The option is available only after initiating a given process.

### Procedure:

1. Go to differential weighing mode, select a series, press procedure button, e.g. <Weighing A> procedure.
2. Press <T> button:
3. List of samples for which the selected procedure can be carried out is displayed.
4. Select a sample that is to be weighed.
5. This option is particularly useful if a series contains a large number of samples, and you want to weigh a sample that is at the end of a series.

Samples		
1	Sample 1	Tare
2	Sample 2	Tare
3	Sample 3	
4	Sample 4	

### 25.7. Deleting Values

Delete option enables deleting last weighing record added to the database. It refers to all processes in the working mode. The software enables deleting only the most recent measurement operation.

### Procedure:

1. If you have saved a weighing record by mistake (sample or tare), i.e. wrong sample or container has been used, press press <Del> button.
2. The weighing record is automatically deleted, the software returns to the previous step of the procedure.

The process can be carried out once only, otherwise respective message informing on error is displayed, deleting a record is aborted.

### 25.8. Printouts

Printouts option enables you to determine content of a particular standard printout, and to define non-standard printout.

Standard printout comprises five internal blocks, each containing different variables. Variable settings: YES – print; NO – do not print.

Settings for header, GLP, and footer printouts are specified in section 14.7. For settings of series and sample printout template read below.



**Report content:**

Series printout content:

- Dashes
- Customer
- Samples
- Empty line
- Dashes
- Signature
- Non-standard printout

Samples printout content:

- Dashes
- Sample
- Sample no.
- Status
- Tare
- Temperature
- Humidity
- Pressure
- Non-standard printout
- Weighing A
  - Weighing A
  - Date
  - Time
  - Level status
  - Warehouse
  - Product
  - Packaging
  - Universal variable 1 ... 5
  - Net
  - Tare
  - Non-standard printout
- Weighing B
  - Weighing B
  - Date
  - Time
  - Level status
  - Warehouse
  - Product
  - Packaging
  - Universal variable 1 ... 5
  - Net
  - Tare
  - Interval
  - Difference
  - Difference %
  - Residue %
  - Non-standard printout

**26. STATISTICAL QUALITY CONTROL- SQC**

**<Statistical Quality Control>** is a working mode designed to support control of product packing process.

It enables detecting surplus or shortfall of product in a packaging.

If the weighing results are stored in the database, then trend analysis can be carried out and displayed in a form of a graph.

The software provides the possibility of controlling a batch comprising up to 1000 samples.

Each completed control process is saved to the SQC database, and its results are ready for previewing at any time. Each series has a determined set of parameters that are stored in the database: maximum, minimum, standard deviation and average value for each batch, etc.

SQC control process can be carried out manually (by pressing <PRINT> button for each

measurement) or automatically (automatically carried out record of stable measurements).

The balances feature module for statistical control processes. It is supported by a database containing list of products with error values (<T4->; <T3->; <T2->; <T1->; <T1+>; <T2+>; <T3+>; <T4+>).

The control process is initiated automatically and completed on controlling a required quantity of samples. As a user you define how many samples are to be controlled, to do it go to SQC settings. After completed control process, a final report can be generated and/or printed. Data on a control is also automatically saved to the Database of SQC Reports.

**Control process:**



- operator selection,
- product selection,
- control start,
- acquiring weighing records,
- control finish (carried out automatically when predefined number of samples is weighed - batch),
- control report print.

**26.1. SQC Activation**









In order to activate SQC mode you need to be assigned with permission level required for carrying out control process.

**Caution!**















*Starting a control requires <Operator> permissions level at least. If a logged user or an anonymous user' permissions level is <Guest> then on control start, message <Unauthorized access> is displayed. For information on logging procedure read section 8 of this user manual, for information on how to grant permissions levels read section 12 of this user manual.*

1. Log in.
2. Set  **SQC** mode parameters. For detailed information read section 26.2.
3. Select a product that is to be controlled (press  button), mind to select a product with correctly entered control data.



List of data to be entered prior control start

	<b>Mass</b>	Product nominal mass
	<b>Tare</b>	Packaging mass in adjustment unit
	<b>SQC</b>	
	<b>Thresholds mode</b>	Declaring whether thresholds values are to be entered in [g], or in percent of the product nominal mass.
	<b>Thresholds' reference value</b>	Declaring which value, nominal or average, is to be the basis for calculation of thresholds by declared error values.
	<b>Batch quantity</b>	Declaring quantity of controlled batch.
	<b>[T4-] error value</b>	Max permissible negative T4 error value with nominal weight value as point of reference.
	<b>[T3-] error value</b>	Max permissible negative T3 error value with nominal weight value as point of reference.



	<b>[T2-] error value</b>	Max permissible negative T2 error value with nominal weight value as point of reference.
	<b>[T1-] error value</b>	Max permissible negative T1 error value with nominal weight value as point of reference.
	<b>[T1+] error value</b>	Max permissible positive T1 error value with nominal weight value as point of reference.
	<b>[T2+] error value</b>	Max permissible positive T2 error value with nominal weight value as point of reference.
	<b>[T3+] error value</b>	Max permissible positive T3 error value with nominal weight value as point of reference.
	<b>[T4+] error value</b>	Max permissible positive T4 error value with nominal weight value as point of reference.
	<b>Disqualifying quantity of samples [Qn-T4]</b>	Max permissible quantity of T4 low limit errors with nominal weight as point of reference.
	<b>Disqualifying quantity of samples [Qn-T3]</b>	Max permissible quantity of T3 low limit errors with nominal weight as point of reference.
	<b>Disqualifying quantity of samples [Qn-T2]</b>	Max permissible quantity of T2 low limit errors with nominal weight as point of reference.
	<b>Disqualifying quantity of samples [Qn-T1]</b>	Max permissible quantity of T1 low limit errors with nominal weight as point of reference.
	<b>Disqualifying quantity of samples [Qn+T1]</b>	Max permissible quantity of T1 high limit errors with nominal weight as point of reference.
	<b>Disqualifying quantity of samples [Qn+T2]</b>	Max permissible quantity of T2 high limit errors with nominal weight as point of reference.
	<b>Disqualifying quantity of samples [Qn+T3]</b>	Max permissible quantity of T3 high limit errors with nominal weight as point of reference.
	<b>Disqualifying quantity of samples [Qn+T4]</b>	Max permissible quantity of T4 high limit errors with nominal weight as point of reference.

**Caution!** For information on how to edit product records read section 30.2 of this user manual.

4. Return to  **SQC** mode home screen, press  button (control start) located in the bottom bar,
5. **<Batch Number>** window with an on-screen keyboard opens (only if **<Request batch number>** parameter is set to **<YES>** parameter),
6. Enter the number of controlled product batch, press  button to confirm.

**Caution!**

You can abort the control process at any time, to do it press  button (control stop) located in the bottom bar.



In the course of control other on-screen keys and function keys,  and  keys are locked.

## 26.2. Mode Related Settings

The supplementary settings enable you to adjust the working mode to your needs and requirements.

### SQC mode settings:



- **Request batch number:** use this function to force the user to enter batch number of a product prior each control procedure start.  
Procedure:
  1. Select **<Request batch number>** parameter, window with NO/YES value is displayed. Select **<No>** – option disabled, or **<Yes>** – option enabled.

2. The previous screen is displayed automatically.
- **Batch number:** use this function to enter identification number for controlled products batch.  
Procedure:
  1. Select  Batch number> parameter, Batch Number edit box with an alphanumeric keyboard is displayed.
  2. Enter the required batch number and press  button to confirm.

For detailed information regarding remaining functions read section 15.7, *Additional Parameters for a Weighing Process*.

### 26.3. Control Operation

Procedure:

1. Press  Product> button to select product to be controlled.
2. Press  button located in the bottom bar to initiate the control; an edit box with an on-screen keyboard opens.
3. Enter the batch number and press  button to confirm the operation. The software proceeds to the next process steps.

In the course of the control, measurement results are analysed in real time and the following prompts are displayed:

- Batch quantity 1 / 10** - A command on process course and the quantity of all measurements in a tested batch.
- Product** - Controlled product name.

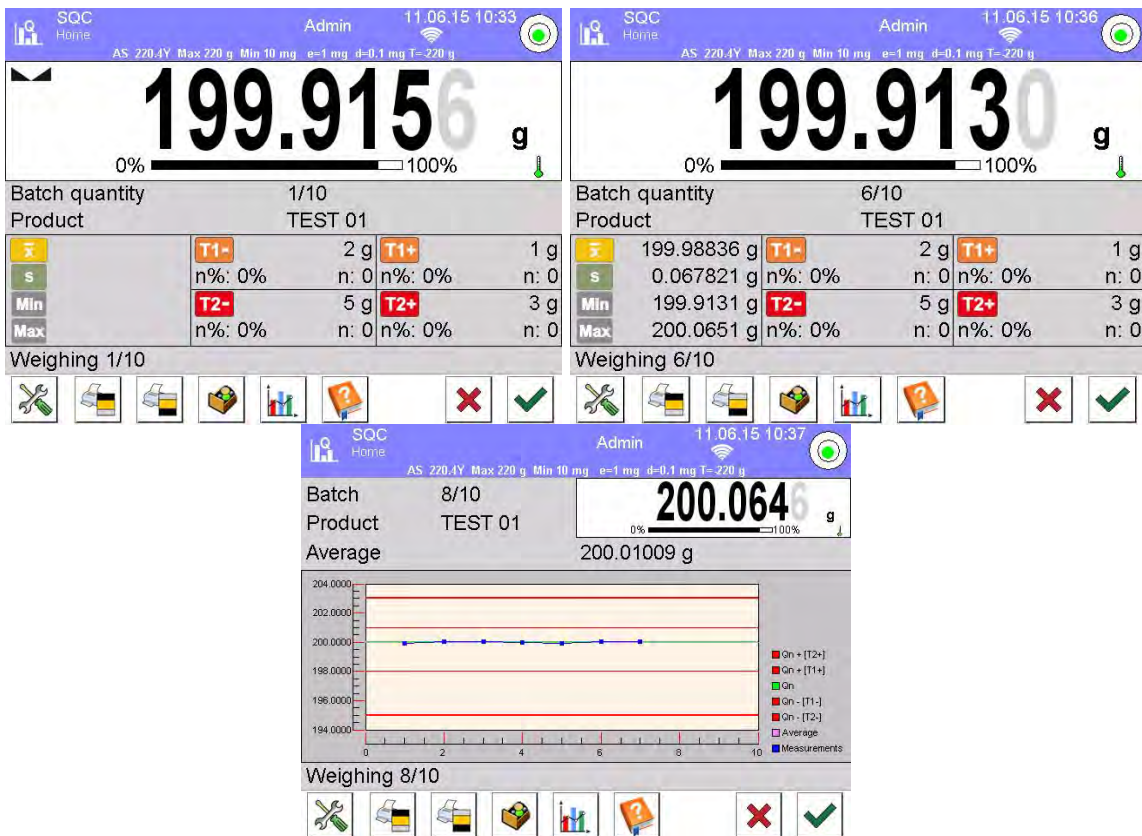

## Control status

There are different control status options differentiated by colour. Particular colour informs you whether the permissible error quantities are out of range or not. Error values and permissible error quantities are specified for a particular product.

<b>T1-</b>	-1 g
Max: 2	n: 1

- no more **T1-** error can occur (yellow)

<b>T2-</b>	-3 g
Max: 1	n: 1

- **T2-** error has occurred, control result is negative (red)

Upon process completion a report is generated and recorded in database.

**Caution!** For a template and an example of a report on a control process read section 26.4 of this user manual.

## 26.4. SQC Control Report

An example of SQC report:

----- SQC -----



Balance type	AS 3Y
Range	220 g
Reading unit	0.0001 g
Balance S/N	442566
Start date	2012.10.19 12:27:09
End date	2012.10.19 12:37:20
Operator	Kowalski
Product	TEST 01
Batch number	
Nominal mass	50 g
Tare	0 g
[T1-] error value	1 g
[T2-] error value	3 g
[T1+] error value	1.5 g
[T2+] error value	4 g
Batch quantity	100
Measurements quantity	30
[T1-] errors quantity	0
[T2-] errors quantity	0
[T1+] errors quantity	0
[T2+] errors quantity	0
Min	50.0525 g
Max	50.3638 g
Average	50.291163 g
Sum	1508.7349 g
Standard deviation	0.133916 g
Method	SQC
Indication	Positive

### Measurements

1. 50.0525 g
2. 50.0525 g
3. 50.0525 g
4. 50.0525 g

-----  
Signature  
.....

## Report template

Open  **Printouts/**  **SQC report printout template**> section to edit a template of a report. Only variables with <YES> attribute are printed on a report.

## 27. PEAK HOLD

**Peak Hold** is a working mode allowing you to snap value of maximum force applied to the weighing pan during one loading.

Apart from standard settings for this mode (described in the *Weighing* mode section), additional parameter has been introduced, it sets threshold value determining function activation.

### 27.1. Mode Related Settings

The supplementary settings enable you to adjust the working mode to your needs and requirements. To access the settings follow the below procedure.

#### Procedure:

1. Press grey workspace area.
2. The following submenus are displayed: Settings, Buttons, Information, Printouts, Series, Profile.
3. Select <Settings> menu.
4. Functions related to Peak Hold mode are displayed.

**THRESHOLD** – value determining start point for peak hold control performed by the balance software. Remember to set this threshold prior to the measuring process.

### 27.2. Peak Hold Operation

1. Enter <PEAK HOLD> mode.
2. Once you select the mode, the function is active.
3. Set the threshold (in grams) determining point beyond which the function starts to register maximum force applied.

From now on the balance registers and holds every single weighing which is above the threshold, and which is higher than the result of the previous peak hold. If the software detects mass above the threshold, the highest detected indication is held on the main display and the pictogram <Max> is shown on the left.



4. In order to print the result press  button.
5. The start of the next process of peak hold measurement is possible only after removing the load

from the weighing pan and pressing  button. This causes returning to the home screen of <Peak Hold> mode. Pictogram <Max> is automatically deleted.

## 28. PRE-PACKAGED GOODS CONTROL

(function disabled for standard balance models)

<  **Prepacked Goods Controls** > is a working mode enabling performance of pre-packaged goods controls (single stand control or multi-stand control), supported by a database containing products and operators. A control initiated using balance is automatically finished after a pre-set packages quantity (samples) has been controlled.

Balances may connect to **E2R SYSTEM** software and form a multi-stand system (network). Each weighing instrument is an independent weighing workstation and information on the control is sent to the computer software. Computer software enables collecting real-time data from each of the connected weighing instruments. The system allows you to start control process using the instrument or computer software.

Collected data allow you to assess quality of produced pre-packaged goods and their conformity with:

- the Regulation by the Central Office of Measures of 3 April 1997, on the requirements concerning quantity inspection of pre-packaged goods control, which inspection is to be carried out by means of random selection of the measurements results and sending those results to pre-packaged goods control procedure (FOR EUROPEAN UNION).
- a company quality control system (internal control).



### Control process:

- operator selection,
- product selection,
- control start,
- acquiring weighing records,
- control finish (carried out automatically when predefined number of packages is weighed),
- control report print.

**Caution!** For detailed information on establishing a connection with <  **E2R System** > read section 'COMPUTER'.

### 28.1. PGC Mode Start-Up

#### Procedure:

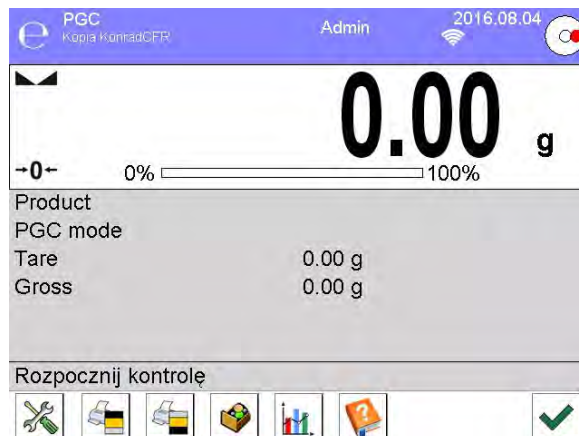

1. Go to the home screen, press  pictogram located in the top bar. <Working modes> submenu is opened.
2. Select <  **PGC** > mode, Prepacked Goods Controls home screen is displayed.
3. <**Start control**> message is visible in the bottom bar along with  button, press it to start the control.





## 28.2. Control Settings

**Caution!** Before entering control settings it is necessary to log in.

Press  button located in  **PGC**> mode home screen, window with control settings is displayed:

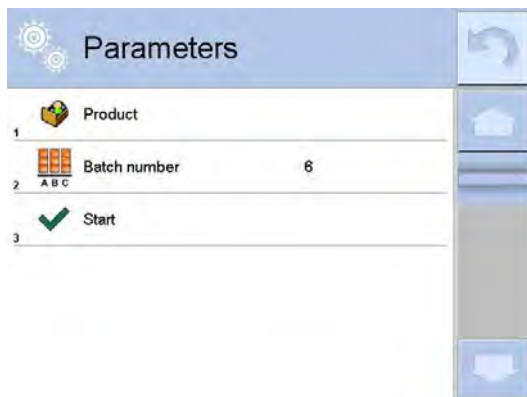

**Where:**



Press to select product from the database



Batch number





Press to start control process

## 28.3. PGC Mode Local Settings

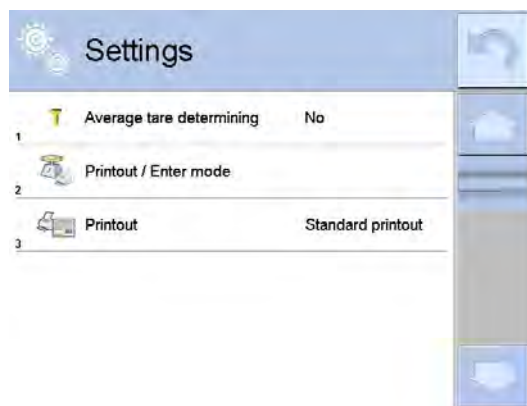
Local settings for  **PGC**> mode are available upon pressing grey workspace area in PGC mode home screen.





	Average tare determination	Press to switch on/off option of average tare determination before control start.
	Printout/Enter mode	For detailed description read section: <b>ADDITIONAL PARAMETERS FOR A WEIGHING PROCESS.</b>
	Printout	

## 28.4. Editing Product for Control Process













In order to edit a product, enter  /  **Database**> submenu.

**Caution!** In case of connection with  **E2R System**> software, editing databases on the balance is disabled. Edition and export of the products to the balance is carried out using computer software.

**Procedure:**

1. Enter <  /  Databases> submenu.
2. Enter <  Products> database and press respective record.

**List of parameters defined for control:**

Pictogram	Data	Description
	<b>Name</b>	Product name
	<b>Code</b>	Product code
	<b>EAN code</b>	Product EAN code
	<b>Mass</b>	Product nominal mass
	<b>Tare</b>	Product tare (set automatically upon selecting a product from the database).
	<b>PGC mode</b>	Control type: Non-destructive average tare, Non-destructive empty – full, Destructive full – empty, Destructive empty –full
	<b>Batch portion</b>	Measurement series for control: Non-destructive empty – full, Destructive full – empty, Destructive empty – full
	<b>PGC: Unit</b>	Unit of a product: [g] or [ml].
	<b>Batch quantity</b>	Declaring quantity of controlled batch
	<b>Interval of average tare determination</b>	Time interval given in [h] determining how often average tare must be estimated for a given product.
	<b>Packaging quantity</b>	Declaring quantity of packages that are to be subjected to process of average tare determination (for Non-destructive average tare type of control)
	<b>Average tare coefficient</b>	Coefficient for threshold of acceptance of standard deviation for average tare. Coefficient range: 0.10 - 0.25.
	<b>Internal control</b>	Submenu for determining internal criteria for a control (see: table below).
	<b>Density</b>	Product density (value range: 0.1g/cm <sup>3</sup> - 5g/cm <sup>3</sup> ).

Apart from the above listed options there are other ones which may be used for different working modes (e.g. CHECKWEIGHING, THRESHOLDS, etc.)

**List of parameters defined for internal criteria:**

<b>Internal control</b>	<YES> - enable internal control criteria, <NO> - disable internal control criteria.
<b>Sample Quantity</b>	Sample quantity for a product
<b>[T1-] error value</b>	Max permissible value of <b>-T</b> error given in unit set for a product. Measurements lower than <b>Qn-T</b> will be considered incorrect.
<b>[T1+] error value</b>	Max permissible value of <b>+T</b> error given in unit set for a product. Measurements higher than <b>Qn+T</b> will be considered incorrect.
<b>Disqualifying quantity of samples [Qn - 2T]</b>	Quantity of <b>-2T</b> errors disqualifying tested sample.



<b>Disqualifying quantity of samples [Qn - T]</b>	Quantity of <b>-T</b> errors disqualifying tested sample.
<b>Disqualifying quantity of samples [Qn + T]</b>	Quantity of <b>+T</b> errors disqualifying tested sample.
<b>Disqualifying quantity of samples [Qn + 2T]</b>	Quantity of <b>+2T</b> errors disqualifying tested sample
<b>Average limit</b>	Mode for determination of average limit value (constant or automatic).
<b>Average limit [-]</b>	Average limit value (minus) for a tested sample (value of average limit as 'constant').
<b>Average limit [+]</b>	Average limit value (plus) for a tested sample (value of average limit as 'constant').
<b>Coefficient value [-Wk]</b>	Multiplier of standard deviation for value of average limit (minus) calculated automatically.
<b>Coefficient value [+Wk]</b>	Multiplier of standard deviation for value of average limit (plus) calculated automatically.

## 28.5. Control Process Start

### Procedure:

1. Log in, make sure that your permissions level allows you to carry out control process.  
**Caution!** For information on logging procedure read section 8 of this user manual, for information on how to grant permissions levels read section 12 of this user manual.
2. Select product with correctly entered control data.

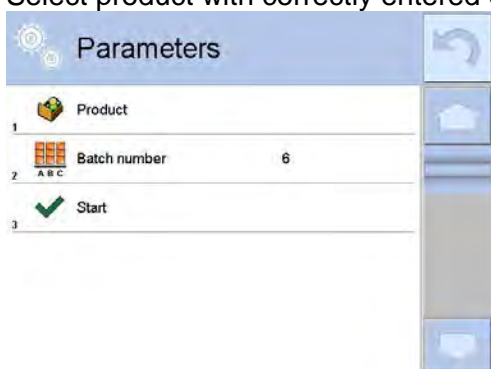

3. Enter weighing mode parameters.

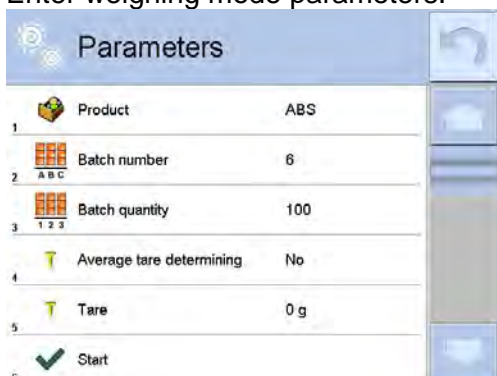

Where:

**Batch number** – identification of controlled products batch.

**Bach quantity** – software controls specified number of samples.

**Average tare determining**

**Packages quantity** – more than 10.

4. Remove load from the weighing pan.

5. Press <START > button located in the bottom. The home screen containing entered data is displayed.

**Caution!**

*If prior to control:*

- Load has not been removed from the weighing pan or if other zeroing requirements have not been met (e.g. unstable indication), balance shows message: <-Err 2>. Upon noticing <-Err 2> message unload the balance and wait until all zeroing requirements are met.
- You have not logged in or you are logged but not assigned with the right permissions to perform control, message: <Access denied> is displayed.
- You have not selected product from the database, message: <Product is not selected> is displayed.



**28.6. Abort Control Procedure**

You can abort control at any moment.

Procedure:

1. Press  button (abort control) located in the bottom part of the process window.
2. The following message is displayed:



3. Press  button to return to the ongoing control. Press  button to abort control and return to **PGC** mode.

Control reports with status <Aborted> is saved to **PGC** database.

**28.7. Aborted Control Restoring Procedure, Power Loss Case**



In case of disconnection from the mains, to prevent loss of data for control being in progress, the program continuously records control results.

For power loss case, the software allows to complete aborted control upon reconnection to the mains.

**Caution!** Remember to restart the balance when unloaded. It is obligatory to run the balance with an empty weighing pan.

During balance restart the software searches for any in course control procedure. If there is one, the following message is displayed:



- Press  button to leave control procedure and proceed to weighing.
- Press  button to complete aborted control procedure.

### 28.8. Non-Destructive Average Tare Control Mode

Prior control you can determine average tare by weighing packages.

#### Procedure:

1. Go to setting window of **PGC** mode.
2. Activate **<Average Tare Determining>** function, to do it press grey field.

The following window is displayed:

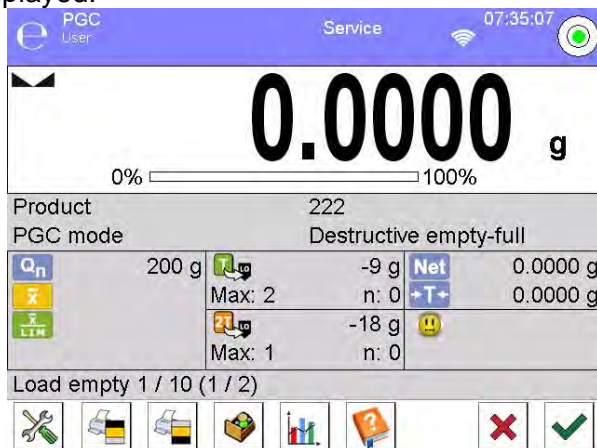

#### Where:

##### Product

 0.25T

  $\bar{x}_{op}$

 s

 T

 2T

 Net

 T



**Load empty**

- Product name
- **0.25T** condition value, given in [g].
- Average mass of a packaging, given in [g].
- Standard deviation.
- Characteristics of sample's negative **T1** errors
- Characteristics of sample's negative **2T1** errors
- Controlled packaging net weight
- Packaging tare
- Packaging control status
- Command for process in progress with specified number of all packagings to be weighed



Display of graph.

- Graph concerns control of mass only, while estimating average tare value, the preview of packaging mass distribution is not possible.



- Information on control



- Abort control process

**Caution!**

If a product is to be controlled by “Non-destructive average tare” mode, then accordingly to Regulation, standard deviation “S” for its packaging mass, based on at least 10 measurements, cannot be lower than 0.1 and greater than 0.25 of maximum permissible negative error T, for nominal packaging mass. The range is set independently for each product in products database.

After the last packaging mass measurement has been performed, the following message is displayed:



- Press button to proceed to control without saving the newly estimated average packaging mass to product data.
- Press button to proceed to control with saving the newly estimated average packaging mass to product data.

Measurements results are analysed continuously during control and displayed in respective fields :



**Where:**  
**Bar Graph**

- Information on product net weight in a form of graph:  
**green bar graph** – mass within tolerance range: between [-T] and [+T] of net weight.  
**yellow bar graph** – mass within tolerance range: between [-T] and [-2T] of net weight.  
**red bar graph** – mass below net mass [NET – 2T].

**Product**

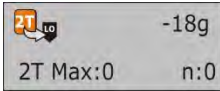
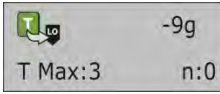

**Load full**



- Name of the controlled product.
- Nominal value of the controlled product.
- Average mass of the controlled product.
- Disqualifying average value.
- Characteristics of sample's **T** negative errors:  
**-9g** - value of **T** negative error,  
**T Max** - permissible quantity of **T** negative error,  
**n** - actual quantity of **T** negative errors.
- Characteristics of sample's **2T** negative errors:  
**-18g** - value of **2T** negative error,  
**2T Max** - permissible quantity of **2T** negative errors,  
**n** - actual quantity of **2T** negative errors.
- Net weight of the controlled product.
- Packaging tare.
- Control status: positive, negative.  
 Prompt regarding process course.
- Command specifying number of all measurements to be done for a given batch.
- Display of numeric data/graph.
- Information on control / results of performed control.
- Abort control process.

- Control status



- positive



- negative (control of sample 2 permitted)



- negative

For status respective field turns to yellow:

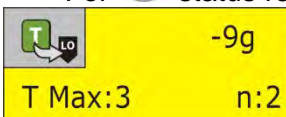

yellow warns that occurrence of another **T** error will end with negative result of control.

For status respective field turns to red:

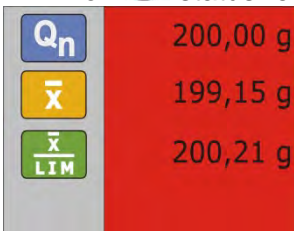



red means that average mass of controlled product is lower than disqualifying average value

- Workspace

To enable display of the measurements results in a form of graph press button:

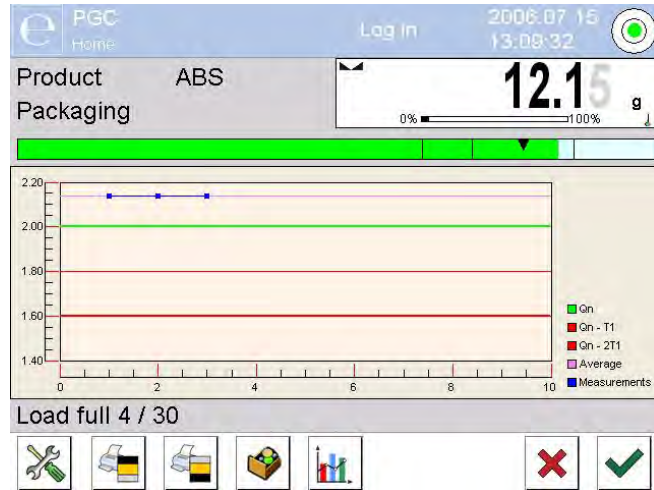



To disable display of the measurements results in a form of graph press  button again.

- Information on the control process

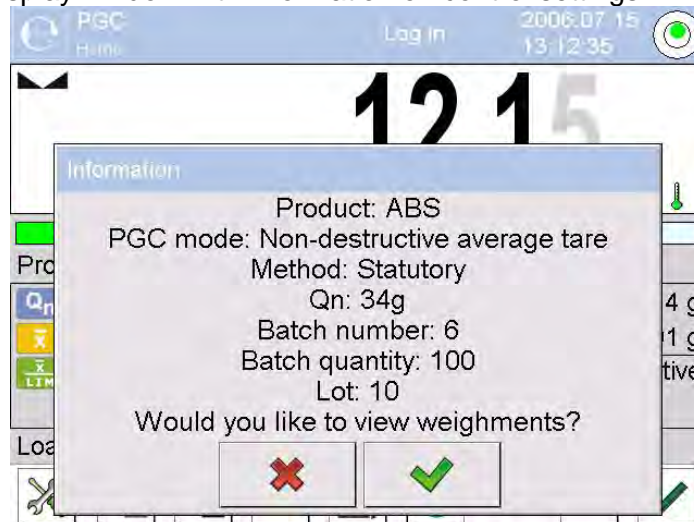

Press  button to display window with information on control settings:

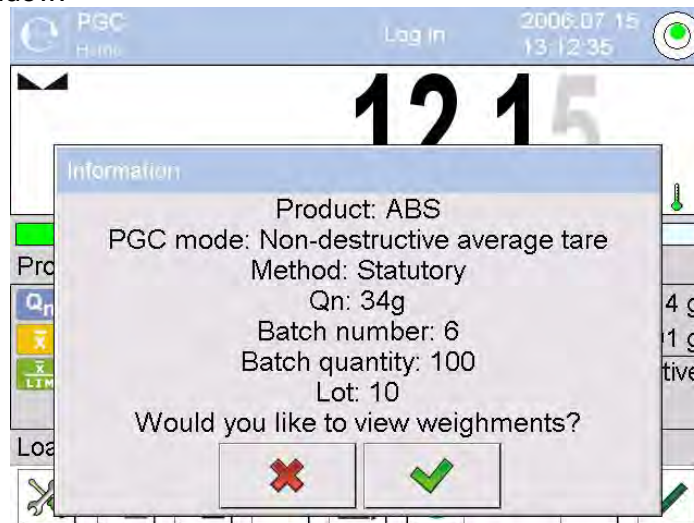

Control-in-progress window:



Press  button to display window with measurements carried out for an ongoing control:

Measurements		
1	 2006.07.15 13:12:29	2.14 g
2	 2006.07.15 13:12:30	2.14 g

Upon control completion, summary of the process is generated, control is automatically saved to database:





The screenshot shows the PGC software interface. At the top, it displays 'PGC Home', 'Log In', and the date '2006.07.15 13:10:44'. A large digital scale reading shows '12.15 g'. Below the reading is a progress bar from 0% to 100%. A dialog box is overlaid on the screen with the following text:

```

X = 2.14 DX = 2 Positive
T- = 0/3 (-0.2) Positive
2T- = 0/1 (-0.4) Positive
Result: Positive

Print report?
  
```

At the bottom of the dialog box are two buttons: a red 'X' button and a green checkmark button.

Press  button to print report using connected printer. Press  button to return to  **PGC** mode settings without printing the report.

**Caution!**

*In case of connection with  E2R System> software, control process summary does not contain 'Print report?' question. All data is automatically sent to the computer software, report may be printed using a computer.*

If the quantity of **T** negative errors detected by the software during the control of sample 1 shall require (as specified by the regulation on PGC) sample 2 to be controlled, then, upon sample 1 measurement completion, the following message is displayed:



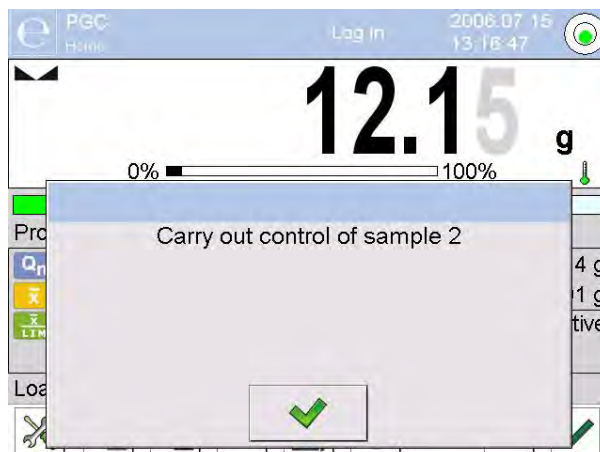

Press  button to confirm. The text and max permissible errors quantity get updated. Upon completed control of sample 2, the software generates control summary. Report on performed control may be printed on a balance-connected printer.

**Caution!**





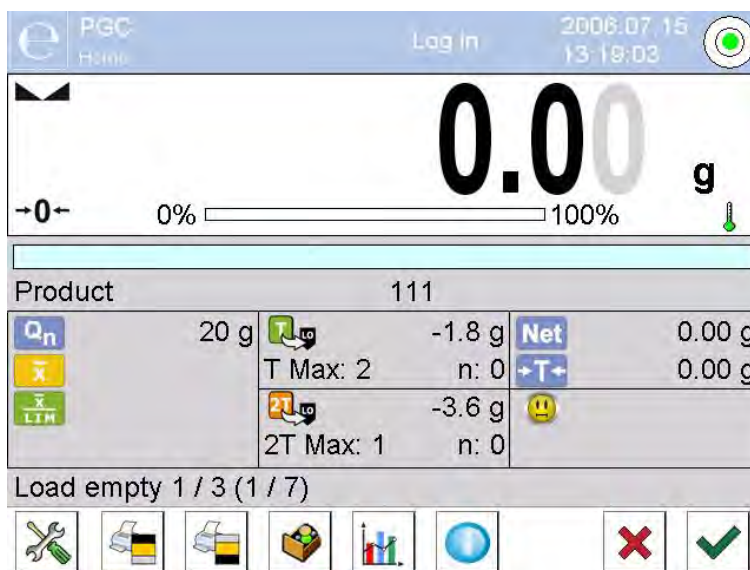

The template and examples of the average tare determination and PGC reports are to be found further down this user manual.

**28.9. Non-Destructive Empty-Full Control Mode**

When you use **Non-destructive empty-full** mode, set **lot** (batch portion) value, to do it enter product data. A message asking you to weigh empty packages first, full next, in the same order is displayed.



Where:  
**Product**  
**Code**

	
	
	
	-4,5g
T Max:2	n:0
	-9g
2T Max:0	n:0
	

- Name of the controlled product.
- Code of the controlled product.
- Nominal value of the controlled product.
- Average mass of the controlled product.
- Disqualifying average value.
- Characteristics of sample's **T** negative errors:
- Characteristics of sample's **2T** negative errors:
- Net weight of the controlled product.



**Load empty 1/3**



- Packaging tare.
- Control status.
- Prompt regarding process course.
- Command specifying value of batch portion.
- Display of numeric data/graph.
- Abort control process.

Upon control completion, a report is generated, control is automatically saved to database.

**Caution!**

*The template and an example of control report are to be found further down this user manual.*

### 28.10. Destructive Empty-Full and Full-Empty Control Mode

In case of **Destructive** control, for lot exceeding 100 pcs, sample set by the software for test is always 20 pcs. The other control assessing criteria are set in accordance with the law regulations.

**Procedure:**

1. Select product from the list, set parameters for destructive control and determine batch portion value.
2. Start destructive control; prompts helping you to go through control process are displayed (as in case of the controls described above).

Depending on set control mode, the order of products to be weighed is either: **empty-full** or **full-empty**.

**Caution!**

*It is necessary to weigh empty packages in the same order as packages filled with product. With this, software correctly calculates mass of a load placed in its corresponding packaging.*

Upon control completion, summary of the process is generated, control is automatically saved to database.

**Caution!**

*The template and an example of control report is to be found further down this user manual.*

### 28.11. Control According to Internal Criteria

1. Select appropriate product with control data entered correctly in accordance with internal criteria (see: previous sections of this user manual).
2. Enter PGC mode parameters into balance memory (in accordance with user manual).
3. Press  button to start control.
4. During the control process the software continuously analyses measurements results and displays them in the appropriate fields informing the user about the control results:

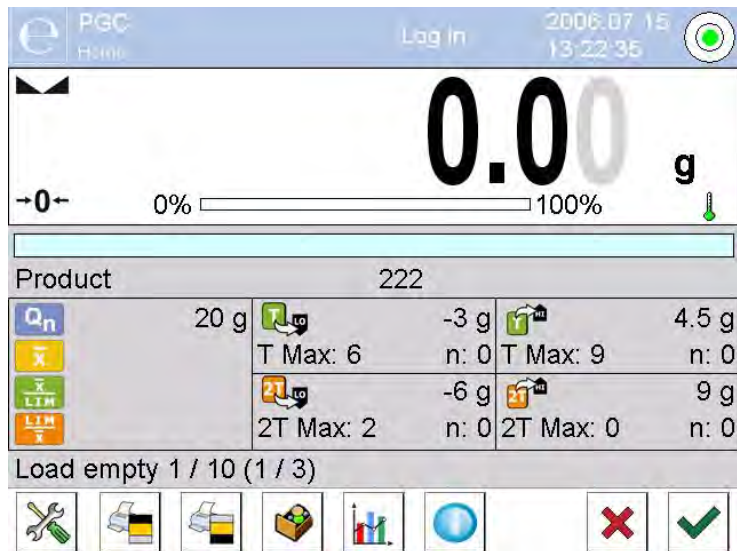

Where:

**Product**

**Code**



$T_{Lo}$	-3g
T Max:2	n:0
$2T_{Lo}$	-6g
2T Max:6	n:0
$T_{Hi}$	4,5g
T Max:0	n:0

$2T_{Hi}$	9g
2T Max:9	n:0

**Load full 1/30**



- Name of the controlled product.
- Code of the controlled product.
- Nominal value of the controlled product.
- Average mass of the controlled product.
- Disqualifying negative average value.
- Disqualifying positive average value.
- Characteristics of sample's **T** negative errors (see: section 28.4 of this user manual)
- Characteristics of sample's **2T** negative errors (see: section 28.4 of this user manual).
- Characteristics of sample's **T** positive errors:  
**4.5g** - value of **T** positive error,  
**T Max** - permissible quantity of **T** positive errors,  
**n** - actual quantity of **T** positive errors.
- Characteristics of sample's **2T** positive errors:  
**9g** - value of **2T** positive errors,  
**2T Max** - permissible quantity of **2T** positive errors,  
**n** - actual quantity of **2T** positive errors.
- Prompt regarding process course.
- Display of numeric data/graph.
- Abort control process.

Upon control completion, a report is generated, control is automatically saved to database.

**Caution!** The template and example of the control report are to be found further down this user manual.

## 28.12. Reports

An example of a report on determining average tare value.

Average Tare Report: U/07/05/13/13/37/T

-----  
Balance type                                   XA 4Y  
Range    220 g  
Reading unit                                   0.001 g  
Balance S/N                                    303  
Date    2013.05.07 13:37:30  
Product                                        product 1  
Tare   33.447 g  
Average tare coefficient                    0.25  
Average tare limit                           1.125 g  
Measurements quantity                     10  
Standard deviation                          0.00483 g  
Method   Statutory



Result   Positive

### Measurements

1. 33.440 g
2. 33.440 g
3. 33.440 g
4. 33.450 g
5. 33.450 g
6. 33.450 g
7. 33.450 g
8. 33.450 g
9. 33.450 g
10. 33.450 g

-----  
Signature  
.....

### Report template

You can edit a template of a report on product control. To do it enter < Printouts/ Average tare report printout template> section. Only variables with <YES> attribute are printed on a report.



An example of a report on product control.

----- PGC Report: U/06/05/13/14/17 -----  
Balance type XA 4Y  
Range 220 g  
Reading unit 0.001 g  
Balance S/N 303  
Start date 2013.05.06 14:15:49  
End date 2013.05.06 14:17:04  
Operator AAAAAA  
Product product 1  
Batch number 99  
Nominal mass 100 g  
Tare 33.447 g  
T1 error value 4.5 g  
T2 error value 9 g  
T1+ error value g  
T2+ error value g  
Batch quantity 500  
Measurements quantity 30  
T1 errors quantity 0  
T2 errors quantity 0  
T1+ errors quantity 0  
T2+ errors quantity 0  
Min 98.579 g  
Max 100.020 g  
Average 99.72983 g  
Sum 2991.895 g  
Average limit [-] 99.70685 g  
Average limit [+] g  
Standard deviation 0.582804 g  
PGC mode Non-destructive average tare  
Method Statutory  
  
Result Positive

Measurements  
1. 100.008 g  
2. 98.579 g  
3. 98.582 g  
4  
.  
28. 100.013 g  
29. 100.012 g  
30. 100.012 g

-----  
Signature  
.....

### Report template

You can edit a template of a report on product control. To do it enter < Printouts/ SQC report printout template> section. Only variables with <YES> attribute are printed on a report.

## 29. MASS CONTROL

(function disabled for standard balance models)

<  **Mass control** > is a working mode that allows you to control mass of a product that is automatically dispensed onto the weighing pan using balance-connected PA-02 automatic feeder. The mode automatically controls a complete batch of tested product (batch quantity parameter must be declared).

### 29.1. Mass Control Global Settings

To enter Mass control mode settings press grey area workspace on the display and select "**Settings**"



menu:

 00285

Request batch number

The parameter requests a batch number before starting mass control process.



Batch quantity

The parameter determines quantity of a batch, i.e. number of product units to be controlled.



Print report

The parameter switches on/off automatic printout of a report upon mass control process completion.







Printout



The parameter enables selecting whether, upon control process completion, a standard or a non-standard printout is to be printed out.

### 29.2. Mass Control Process

Prior to process start carry out the following steps:

- Set batch quantity for mass controls that are to be performed. Press grey workspace on a display and select <  **Settings** > parameter. Next select  **Batch quantity** > parameter and enter quantity of units that are to be controlled in a current automatic mass control process. Press  button to confirm.
- Set < **Min** > parameter, provide weight value lower than mass of the lightest controlled unit. Select such threshold value that will prevent saving the measurement on the final report when the dispensed element has lower mass than the smallest element in controlled series (e.g. half of a pill). In case of the above situation, if < **Min** > parameter is set correctly, weighing instrument's software omits such measurement and continues mass control process.
- Set < **Max** > parameter. Select such threshold value that will prevent saving the measurement on the final report when the dispensed element has greater mass than the biggest element in controlled series (e.g. two elements dispensed at the same time). In case of the above situation, if < **Max** > parameter is set correctly, weighing instrument's software omits such measurement and continues mass control process.
- Set <  **Dosing speed** > parameter, determined in [%] between 0% and 100%, and nominal mass, set limits for errors, with minus sign - <T4->; <T3->; <T2->; <T1->; <T1+>; <T2+>; <T3+>; <T4+>, and maximum quantity of particular errors occurrence. Errors are set as percent of nominal mass (relative value) or in mass unit (absolute value). Dosing speed, mass values, Min and Max thresholds and errors are parameters specified individually for **each product**.

#### Procedure:

1. Go to the home screen of < **Mass control** > mode, press **SETUP** button.
  2. Select <  **Databases** > parameter first.
  3. Enter <  **Products** > database.
  4. Select product for which the values are to be set.
  5. To enter error values and permissible quantity go to Setup/Databases/Product/SQC parameter.
  6. Set required parameters and return to the home screen.
- Select controlled product from the products database <  >.

- Set required parameters, press ✓ button to start automatic mass control.
- Automatic control is started. The weighing instrument is tared and the feeder starts dispensing the first element onto the weighing pan.
- With the first element on the weighing pan, the feeder pauses, the element is weighed; the first stable measurement is carried out.
- The measurement is saved, the weighing instrument is zeroed, the next element is dispensed onto the weighing pan. The weighing process is carried out analogously.
- The cycle is repeated until all pieces determined for <Batch quantity> process are weighed.
- The following information is displayed during control process:
  - Reference sample quantity
  - Product
  - Average,
  - Standard deviation
  - T1- errors quantity
  - T1+ errors quantity
- Upon completed measuring process of a particular batch, a report is generated, saved to balance's database and printed on a balance-connected printer.

**Caution!** Each control process can be aborted if necessary, to abort a process press ✗ button. The process is stopped and control cancelled (no report is generated).

### 29.3. Printouts

Printouts option enables you to determine content of a particular standard printout, and to define non-standard printout.

Standard printout comprises four internal blocks, each containing different variables.

Variable settings: YES – print; NO – do not print.

Settings for header, GLP, and footer printouts are specified in section 14.7. For settings of mass control report read below.

**Caution!**

*In order to specify which measurement data is to be printed on a report it is necessary to modify settings for <Weighing printout template> parameter. To enable particular measurement data printout set <YES> value for it.*

**Report content:**

- Working mode
- Date
- Time
- Balance type
- Balance S/N
- Report no.
- Operator
- **Name and surname**
- Product
- Start date
- End date
- Batch number
- Reference sample quantity
- Nominal mass
- **T4- threshold**
- **T3- threshold**
- **T2- threshold**
- **T1- threshold**

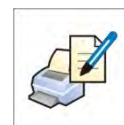



















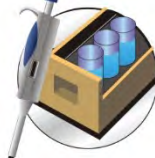

- T1+ threshold
- T2+ threshold
- T3+ threshold
- T4+ threshold
- Measurements
- T4- errors quantity
- T3- errors quantity
- T2- errors quantity
- T1- errors quantity
- T1+ errors quantity
- T2+ errors quantity
- T3+ errors quantity
- T4+ errors quantity
- Average
- Mean [%]
- Standard deviation
- Standard deviation [%]
- Min
- Max
- Empty line
- Dashes
- Signature
- Non-standard printout

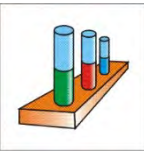
#### 29.4. Performed Mass Control Report

Upon each completed mass control process a report is generated. The report is saved to < **Mass controls**> database. Report files are named by the date and time particular process performance.

### 30. DATABASES

The balance features the following databases <  >:

 PRODUCTS	 WEIGHING RECORDS	 CUSTOMERS
 FORMULATIONS	 FORMULATIONS REPORTS	 DENSITY REPORTS
 CONTROL REPORTS	 AVERAGE TARES	 PIPETTES
 PIPETTE CALIBRATION REPORTS	 SERIES	 MINIMUM SAMPLE WEIGHT
 MASS CONTROLS	 AMBIENT CONDITIONS	 PACKAGES
 WAREHOUSES	 PRINTOUTS	 UNIVERSAL VARIABLES
 MANAGE THE DATABASE		

### 30.1. Database Connected Operations

Databases can be operated only by an authorized personnel.

**Procedure:**

1. Press and hold respective database pictogram.
2. Database menu is displayed.
3. Select one of the available entries (entries set is conditioned by a database).

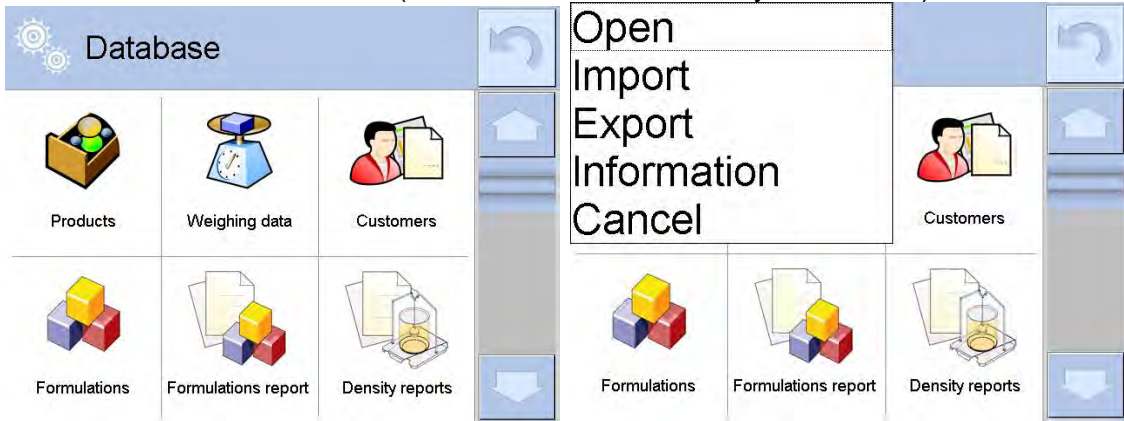

**Entries:**





- OPEN – select to enter a database (alternative method for database entering: single click on given database field).
- IMPORT – select to import data from a USB flash drive. Plug the USB flash drive to a USB port, upon its detection a window with a list of saved files is displayed. Select file with data to be imported. The copying starts automatically. Upon completion of the process a message: <Completed> is displayed. Confirm completion.
- EXPORT – select to export data from a selected database to a USB flash drive. Plug the USB flash drive to a USB port, upon its detection the software automatically starts a copying process. Upon completion of the copying process a window with both, a file name to which data has been saved and message: <Completed> is displayed. Confirm completion.
- INFORMATION – select to display information about database content (see the picture below).



Press  button to return to the previous window.



- CANCEL – select to return to the home screen.

**List of typical database operations:**

- Adding entry to a database <>. 
- Searching for a record in a database by name <  >.
- Searching for a record in a database by code <  >.
- Searching for a record in a database by date <  >.



- Exporting database content to a USB flash drive via USB port <>.
- Printing data on a specific record in a database <>.

The above processes are initiated by dedicated buttons located on the top of the display. Follow the displayed commands.

### 30.2. Products

<Products> database contains names of all products that are weighed, counted or controlled.

#### Procedure:

1. Enter <> Databases> submenu, press < Products> entry.
2. Press  < Add> button to add a new product to the database, or
3. Select already existing product.

#### List of parameters defined for a product:

- |  |   |
|--|---|
| 1. Name                                    | [Product name]  |
| 2. Description                             | [Product description]   |
| 3. Code                                    | [Product code]  |
| 4. EAN code                                | [Product EAN code]  |
| 5. Mass                                    | [Unit mass of a product]  |
| 6. Dosing speed                            | [Option available for <Mass control> mode, determines in [%] (0% - 100%) feeder dosing speed. The value of dosing speed is conditioned by size, shape and mass of dispensed parts (pills), it has to be determined by tests]  |
| 7. Min                                     | [Minimum mass for weighing the product using result control thresholds – LO. Value of <T1-> error for <Mass control> mode determined as percent of the nominal mass]  |
| 8. Max                                     | [Maximum mass for weighing the product using result control thresholds – HI. Value of <T1+> error in working mode <Mass control> working mode determined as percent of the nominal mass]  |
| 9. Tolerance                               | [% value calculated versus mass (5) denoting measuring area in which the measurement is recognized as correct.]   |
| 10. Tare                                   | [Product's tare value, set automatically on selecting a product from the database]  |
| 11. Price                                  | [Unit price of a product]   |
| 12. PGC mode                               | [Control mode (Non-destructive Average tare, Non-destructive Empty – Full, Destructive Full – Empty, Destructive Empty – Full)]   |
| 13. Batch portion                          | [Measuring batch for control: Non-destructive Empty – Full, Destructive Full – Empty, Destructive Empty – Full]   |
| 14. SQC: Unit                              | [Product measuring unit]  |
| 15. Batch quantity                         | [Option available only for <PGC> mode, specifies controlled product batch quantity]   |
| 16. Interval of average tare determination | [Option available only for <PGC> mode, specifies minimum time interval needed for estimation of a packaging average tare; given in [h]; if software detects that pre-set time interval has passed, it displays a message: <Estimate average tare>. The message has informative character and you can decide whether to carry out the process or not.] |
| 17. Packages quantity                      | [Option available only for <PGC> mode, specifies number of packagings needed for estimation of average tare]  |

18. Internal control	[Option available only for <PGC> mode, allows for specification of internal control criteria accordant with company standards for a given product]
19. SQC	[Option available only for <SQC> and <Mass control> modes, allows for specification of internal control criteria accordant with company standards for a given product]
20. Density	[Product's density, used as sample density for compensating air buoyancy,] - [g/cm <sup>3</sup> ]
21. Shelf-life time in days	
22. Date	[Product's date (constant)]
23. VAT	[VAT value related to a product]
24. Ingredients	[Field for inserting names of product's ingredients, or for additional description regarding product's features, application, etc.]
25. Printout	[Template assigned to a product]

**Caution!**



*Remember to assign products to corresponding functions, as some of data values are attributed according to their modes, e.g. thresholds in <Checkweighing> mode are set in [g], while thresholds in <Parts counting> mode are set in [pcs]. The values are selected automatically depending on which mode is enabled while entering a database.*

### 30.3. Weighing Records

Each weighing result sent from the weighing device to a printer is saved to weighings database (read section 16.1, *Result control*).

You can preview data of particular weighing records.

**Procedure:**

1. Enter  **Databases** submenu.
2. Enter  **Weighing records** database and press respective record.



**List of parameters defined for a weighing record:**

1. Measurement date.
2. Measurement result.
3. Tare value.
4. Stable/unstable measurement marking.
5. Air buoyancy control on/off marking.
6. Product name.
7. Operator.
8. Customer, customer name.
9. Working mode name.
10. Warehouse, source warehouse name.
11. Packaging, name of tare applied during product weighing.
12. Result control, information regarding range within which the weighed product is placed:  
MIN – below LOW threshold (possible only if <Result control> is set to <NO> value),  
OK – between the LOW and HIGH thresholds,  
MAX – above HIGH threshold (possible only if <Result control> is set to <NO> value).
13. Weighing platform no., field with number of a weighing instrument by means of which a measurement was carried out.
14. Level status, information on level status maintained during the measurement.
15. Ambient conditions alerts, information regarding stability of temperature and humidity during the measurement.

### 30.4. Customers

Customers database contains name of Customers for whom the measurements are carried out.

**Procedure:**

1. Enter < Databases> submenu and press <Customers> entry.
2. Press < Add> button to add a new customer to the database, or
3. Select already existing customer.



**List of parameters defined for a customer:**

1. Customer name
2. Customer code [internal code identifying a customer]
3. TIN
4. Address
5. Postal code
6. City
7. Discount
8. Printout [type of printout, customer-related label]

**30.5. Formulations**

Formulations database stores all created recipes. The recipes can be carried out automatically.

**Procedure:**

1. Enter < Databases> submenu and press < Formulations> entry.
2. Press < Add> button to add a new formulation, or
3. Select already existing formulation.

**List of parameters defined for a formulation:**

1. Name
2. Code
3. Ingredients
4. Ingredients quantity
5. Sum

**30.6. Formulations Reports**

Formulation reports provide information about carried out formulations. Each report can be previewed, searched by name, date, code or exported and printed out.

**Procedure:**

1. Enter < Databases> submenu and press < Formulations reports> entry.
2. Select report, if not visible, scroll the list using navigation buttons.
3. Report is named by date and time; e.g. 2011.10.12 15:12:15.

**Caution!** It is possible to use 'search report' option.



**List of formulation reports data:**

1. Start date
2. End date
3. Formulation
4. Sum
5. Target value
6. Operator
7. Customer
8. Warehouse
9. Measurements quantity
10. Status

### 30.7. Density Reports

Density reports provide information about carried out density determination processes of solids, liquids and air. Each report can be previewed, searched by name, date, code or exported and printed out.

#### Procedure:

1. Enter  Databases> submenu and press <  Density reports> entry.
2. Select report, if not visible, scroll the list using navigation buttons.
3. Report is named by date and time; e.g. 2011.12.12 11:12:15

**Caution!** It is possible to use 'search report' option.

#### List of density reports data:

- |                                    |  |
|------------------------------------|--|
| 1. Sample number                   | [field with a value, if in Density mode <YES> value is set for <Request sample number> parameter]        |
| 2. Start date                      |  |
| 3. End date                        |  |
| 4. Density                         | [calculated density of a sample, liquid or air]  |
| 5. Volume                          | [calculated volume of tested sample, <i>density measurement of solid body</i> ]                          |
| 6. Procedure<br>report may change] | [depending on selected procedure, data contained on a  |
| 7. Operator                        | [name of an operator carrying out the procedure]   |
| 8. Product                         | [name of tested sample]  |
| 9. Standard liquid                 | [name of a liquid used for determining density <i>of solid object</i> ]                                  |
| 10. Standard liquid density        | [ <i>density determination of solid object</i> ]   |
| 11. Temperature                    | [temperature of liquid used for carrying out a measurement, <i>density determination of solid body</i> ] |
| 12. Sinker volume                  | [ <i>density determination of a liquid</i> ]   |
| 13. Mass of steel standard         | [ <i>density determination of air</i> ]  |
| 14. Mass of aluminium standard     | [ <i>density determination of air</i> ]  |
| 15. Density of steel standard      | [ <i>density determination of air</i> ]  |
| 16. Density of aluminium standard  | [ <i>density determination of air</i> ]  |
| 17. Weighing 1                     | [mass measurement of tested sample or a sinker in the air, or mass of measured steel standard]           |
| 18. Weighing 2                     | [mass measurement of tested sample or a sinker in liquid, or mass of measured aluminium standard]        |

### 30.8. Control Reports

Each product control carried out using SQC or PGC mode is sent to a printer or saved to <**Controls reports**> database. Each control saved to the database features specific number assigned at the moment of control completion.

#### Control number format:

**X / y y / M M / d d / H H / m m**, where:

X - control type, marked as follows:

U - control regulated by the act,

Z - control completed by an operator,

W - control regulated by an internal criteria for PGC or SQC mode

yy - year of control end,

MM - month of control end,

dd - day of control end,



HH - hour of control end,  
mm - minute of control end,  
You can preview data on each control.

**Procedure:**

1. Enter  Databases> submenu, follow procedure described in section 30 of this user manual.
2. Enter <Prepackaged Goods Controls> database and select a desired control record.

**List of parameters defined for control:**

- |                           |   |
|---------------------------|---|
| 1. Batch number           | [batch number of controlled product]  |
| 2. Result                 | [control status (result)]   |
| 3. Start date             | [control start date]  |
| 4. End date               | [control end date]  |
| 5. Product                | [name of controlled product]  |
| 6. Operator               | [name of an operator carrying out control]  |
| 7. Average                | [average value from carried out measurements]   |
| 8. Average limit          | [average disqualifying value]   |
| 9. Standard deviation     | [average standard deviation]  |
| 10. Batch quantity        | [quantity of a batch; value for which the software accepts the size of tested sample in accordance with the regulation] |
| 11. Measurements quantity | [quantity of carried out measurements]  |
| 12. Method                | [control method (regulated by the act or by internal criteria)]   |

For SQC mode controls, the data comprise the following values.  
Each report on completed product control is sent to a printer and saved to the <Controls reports> database. Each control saved to the database features specific number assigned at the moment of control completion.

**Control number format:**

yy / MM / dd / HH / mm / ss, where:

yy - year of control end,  
MM - month of control end,  
dd - day of control end,  
HH - hour of control end,  
mm - minute of control end,  
ss - second of control end.

You can preview data on each control.

**Procedure:**

1. Enter  Databases> submenu, follow procedure described in section 30 of this user manual.
2. Enter <SQC reports> database and press respective record.

**List of parameters defined for control:**

- |                           |   |
|---------------------------|---|
| 1. Batch number           | [batch number of controlled product]  |
| 2. Result                 | [control status (result)]   |
| 3. Start date             | [control start date]  |
| 4. End date               | [control end date]  |
| 5. Product                | [name of controlled product]  |
| 6. Operator               | [name of an operator carrying out control]  |
| 7. Average                | [average value from carried out measurements]   |
| 8. Average limit          | [average disqualifying value]   |
| 9. Standard deviation     | [average standard deviation]  |
| 10. Batch quantity        | [quantity of a batch; value for which the software accepts the size of tested sample in accordance with the regulation] |
| 11. Measurements quantity | [quantity of carried out measurements]  |

12. Method [control method (regulated by the act, by internal criteria or by SQC)]
13. Measurements graph

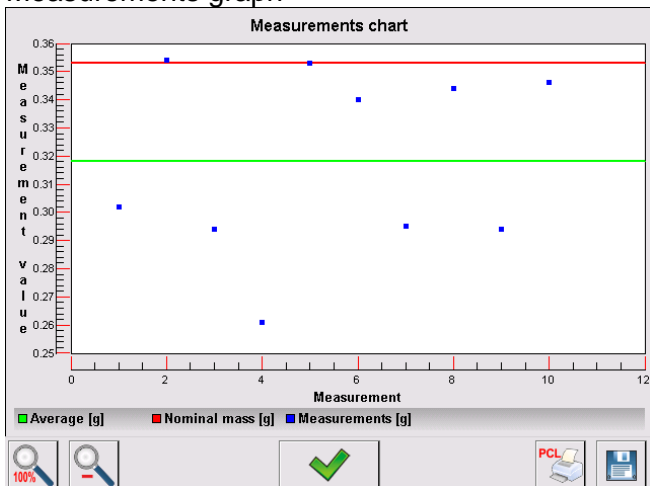

14. Measurements graph with thresholds:

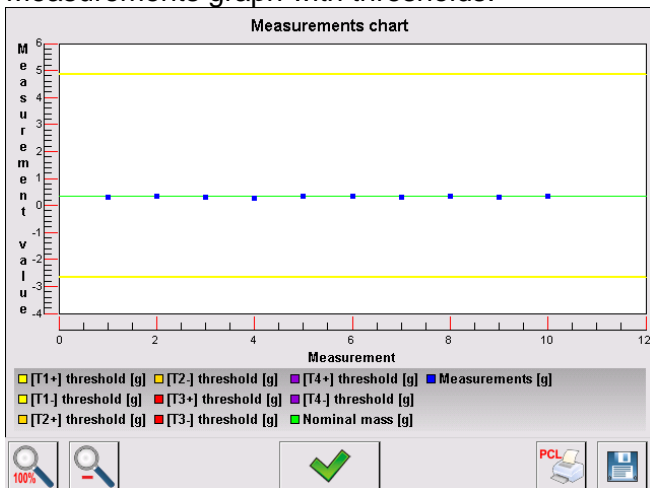

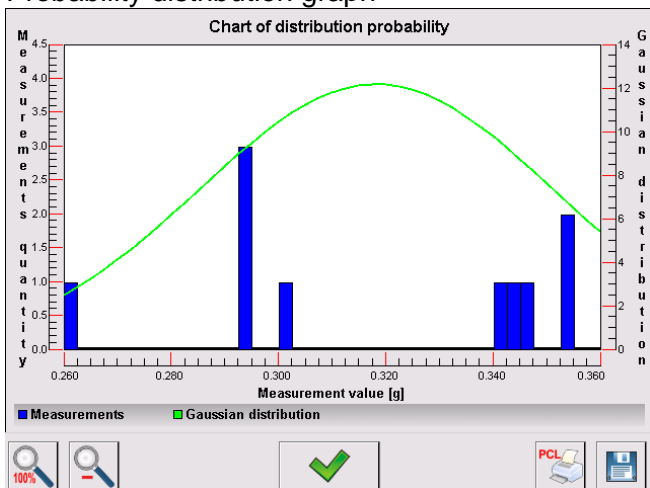

15. Probability distribution graph





### 30.9. SQC Statistics

SQC Statistics database enables you to list and compare all measurements performed for a particular product. For each product it is possible to preview reports on particular controls, generate graph presenting the course of measurements obtained for all tests of the given product, print and export data.

**Procedure:**

1. Enter <  Databases> submenu and press <  SQC Statistics> entry.
2. Select product for which tests history is to be generated.
3. Specify data that is to be searched (lot number, start date and end date).
4. Display list of reports on controls that meet the specified criteria (product, performance date).
5. Generate measurements graph.

**To generate measurements graph:**



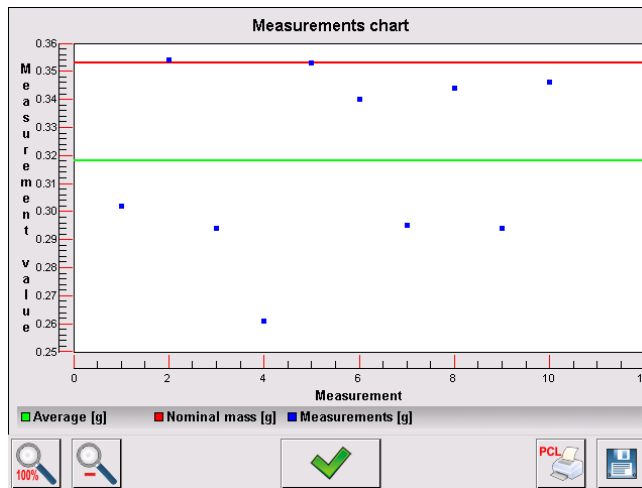

1. Enter <  Databases> submenu.
2. Press <  SQC Statistics> entry.
3. Select product for which tests history is to be generated.
4. Specify data that is to be searched (lot number, start date and end date).
5. Select <All-in-one report> option.
6. Select <  Measurements graph> option.

The program generates and displays (in a coordinate system) a graph presenting results of product drying processes: Result/Measurement number.

Graph example:



Bottom bar tools:

-  Press to display complete graph.
-  Press to zoom out the screen content.
-  Press to go back to the previous window.
-  Press to print the graph using PCL printer.
-  Press to save the graph as \*.bmp file to USB flash drive connected to USB port.

## 30.10. Average Tares

*(function disabled for standard balance models)*

Prior to **<Non-destructive average tare>** control you can determine average tare by packages weighing. Each process is automatically saved to  **Average tares** database. Each control saved to the database features specific number assigned at the moment of control completion.

### Control number format:

**X / y / M M / d d / H H / m m / T**, where:

X - control type, marked as follows:

U - control regulated by the act,

Z - control completed by an operator,

W - control regulated by internal criteria,

yy - year of control end,

MM - month of control end,

dd - day of control end,



HH - hour of control end,

mm - minute of control end,

T - control from average tare value determination.

You can preview data on each process of average tare value determination.

### Procedure:

1. Enter  **Databases**> submenu, follow procedure described in section 30 of this user manual.
2. Enter  **Average tares**> database and select a desired control record.



### List of parameters defined for average tare:

1. Product [name of a product, packaging of which is subjected to average tare value determination]
2. Status [process status (result)]
3. Date [process performance date]
4. Tare [determined packaging tare value]
5. S [average standard deviation]
6. 0.25 T1 [the value of a criterion for process result]
7. Measurements quantity [quantity of carried out tare value measurements]
8. Operator [name of an operator carrying out the process]
9. Method [control method (regulated by the act or by internal criteria)]

## 30.11. Pipettes

Pipettes database contains data of pipettes that are to be calibrated.

### Procedure:

1. Enter  **Databases**> submenu and press  **Pipettes**> entry.
2. Press  **Add**> button to add a new pipette, or
3. Select already existing pipette.

### List of parameters defined for pipettes:



1. Name
2. Code
3. Model
4. Tip
5. Volume type

6. Nominal volume
7. Minimum volume
8. Channels quantity
9. Type
10. Tested volumes

### 30.12. Pipette Calibration Reports

Pipette reports provide information about carried out pipettes calibrations. In case of multichannel pipettes, reports are generated for each channel separately. Each report can be previewed, searched by date or exported and printed out.

#### Procedure:

1. Enter  Databases> submenu and press  Pipette calibration reports> entry.
2. Select report, if not visible, scroll the list using navigation buttons.
3. Report is named by date and time; e.g. 2012.03.12 11:12:15.

**Caution!** It is possible to use 'search report' option.



#### List of pipette calibration report data:

- |   |  |
|---|--|
| 1. Pipette                              | [pipette name]   |
| 2. Serial no.                           | [serial no. entered during calibration]  |
| 3. Channel no.                          |  |
| 4. Start date                           |  |
| 5. End date                             |  |
| 6. Operator                             | [name of an operator carrying out calibration]   |
| 7. Customer                             | [customer name]  |
| 8. Measurements quantity                | [quantity of measurements for each tested volume]  |
| 9. Operation with adherence to ISO 8655 | [information if errors comply with the standard]   |
| 10. Status                              | [information whether errors are below permissible values accepted for the tested volume] |
| 11. Temperature                         | [average temperature value during the process]   |
| 12. Humidity                            | [average humidity value during the process]  |
| 13. Pressure                            | [average pressure value during the process]  |
| 14. Water temperature                   | [average water temperature during the process]   |
| 15. Z coefficient                       | [coefficient value for given temperature]  |

### 30.13. Series

Series database contains series data and samples measurements.

#### Procedure:

1. Enter  Databases> submenu and press  Series> entry.
2. Press  Add> button to add a new series, or
3. Select already existing series.

#### List of parameters defined for series:



1. Name
2. Code
3. Customer
4. Samples
5. Samples quantity

### 30.14. Minimum Sample Weight

Minimum sample weight database contains data concerning declared methods and minimum sample weights.

**Caution!** Only authorized RADWAG personnel can add new minimum sample weight records or make changes in those stored in the database.

#### Procedure:

1. Enter  Databases> submenu and press  Minimum samples weights> entry.
2. Press  Add> button to add a new minimum sample weight, or
3. Select already existing weight.

#### List of parameters defined for minimum sample weights:

1. Name [name of a method used to determine minimum sample weight]
2. Code [method code]
3. Description [method overview]
4. Subsequent control [a field for entering expiry date of the minimum sample weight. 2 weeks before the expiry date, a pictogram of a clock is displayed next to the status pictogram; the clock pictogram informs on elapsing validity date; contact RADWAG representative to carry out necessary changes in minimum sample weight settings]
5. Thresholds [parameter for entering minimum sample weight data and range of packaging mass (tare) with applicable criteria:  
**Tare** – maximum tare value, for which the minimum sample weight is obligatory. You can enter three characteristic quantities: 0.000g, optional mass value from weighing instrument's measuring range, and maximum capacity (see examples below).  
**Minimum mass** – value of the minimum sample weight determined for a particular weighing device on site using respective methods.]

#### **Example no. 1, XA 220.4Y balance with d=0.0001 g:**

List of MSW values determined for the following packaging values:

No.	Tare value	Minimum sample weight	Overview
1	0.0000 g	0.1000 g	Minimum sample weight refers to all net weight values when weighing is carried out without use of a tare container (<TARE> button NOT used).
2	10.0000 g	1.0000 g	Minimum sample weight refers to all net weight values when weighing is carried out using a tare container of mass ranging from 0.0001 g to 10.0000 g inclusive (<TARE> button used).
3	50.0000 g	2.5000 g	Minimum sample weight refers to all net weight values when weighing is carried out using a tare container of mass ranging from 10.0001 g to 50.0000 g inclusive (<TARE> button used).
4	200.0000 g	4.0000 g	Minimum sample weight refers to all net weight values when weighing is carried out using a tare container of mass ranging from 50.0001 g to 200.0000 g inclusive (<TARE> button used).

**Example no. 2, XA 220.4Y balance:**

No.	Tare value	Minimum sample weight	Overview
1	220.0000 g	0.5000 g	Minimum sample weight refers to all net weight values when weighing is carried out using a tare container of mass value comprised within the whole weighing range (<TARE> button used), and to all net weights that are weighed without a packaging (the <TARE> button not used).

**Example no. 3, XA 220.4Y balance:**

No.	Tare value	Minimum sample weight	Overview
1	0.0000 g	0.2500 g	Minimum sample weight refers to all net weight values when weighing is carried out without use of a tare container (<TARE> button NOT used). In case of such settings, the minimum sample weight is valid only when you weigh samples without use of tare containers. If taring function is used then pictogram informing on use of minimum sample weight goes blank and the software carries out weighing with tare (no determined minimum sample weight).

You can preview the entered data, but you are not allowed to edit it.

**30.15. Mass Controls**

*(function disabled for standard balance models)*

Each report on completed product control is sent to a printer and saved to the **<Mass controls>** database. Each control saved to the database features specific number assigned at the moment of control completion.

**Mass control number format:**

**y y / M M / d d / H H / m m**, where:

- yy - year of control end,
- MM - month of control end,
- dd - day of control end,
- HH - hour of control end,
- mm - minute of control end,





You can preview data on each control.

**Procedure:**













1. Enter  Databases> submenu, follow procedure described in section 30 of this user manual.
2. Enter **< Mass controls >** database and press respective record.

**List of parameters defined for control**

The reports contain the following information:

 00285	Batch number	Number of controlled batch
	Start date	Control process start date
	End date	Control process end date
	Operator	Operator carrying out control process
	Product	Controlled product



	Average	Mean mass value determined during control
	Mean [%]	Mean mass value determined during control [%]
	Standard deviation	Standard deviation of carried out control
	Standard deviation [%]	Standard deviation of carried out control [%]
	Min	Min threshold, mass below this threshold is not included into control.
	Max	Max threshold, mass above this threshold is not included into control.
	T4- errors quantity	Quantity of errors in the course of control
	T3- errors quantity	
	T2- errors quantity	
	T1- errors quantity	
	T1+ errors quantity	
	T2+ errors quantity	
	T3+ errors quantity	
	T4+ errors quantity	
	Batch quantity	Controlled batch quantity determined in a report
	Measurements graph	Graph presenting particular measurements in coordinates system.
	Probability distribution graph	

Each report can be printed.

**Procedure:**



1. Select the report and display its details.
2. Press  Print> button located on the upper bar.
3. The printer connected to balance's terminal prints the report.

The database can be exported to a file. To do that, press  **Export to a file>** button.

### 30.16. Ambient Conditions

<Ambient conditions> database contains parameters related to ambient conditions. Depending on the balance type, the ambient conditions report can provide values of temperature, humidity, atmospheric pressure. If the given balance is connected to a THB module then its indications are recorded to the database too.

**Procedure:**



1. Enter  Databases> submenu and press  Ambient conditions> entry.
2. Select report, if not visible, scroll the list using navigation buttons.
3. Report is named by date and time.

**Caution!** It is possible to use 'search report' option.

### 30.17. Packages

<Packages> database contains list of packages for which a name, code and mass value are specified. The tare value is automatically applied when a name of a packaging is selected from the database during weighing process. The tare value is displayed with minus sign.

#### Procedure:



1. Enter  Databases> submenu and press  Packages> entry.
2. Press  Add> button to add a new packaging, or
3. Select already existing and insert data on the packaging.

**Caution!** It is possible to use 'search report' option.

### 30.18. Warehouses

Depending on the organization of work, the warehouses database contains list of places used for picking up a sample for weighing or list of places to which a weighed sample was delivered. Each warehouse has to have its name, code and description specified. During weighing process, and on selecting name of a warehouse, it is automatically assigned to the measurement result.

#### Procedure:



1. Enter  Databases> submenu and press  Warehouses> entry.
2. Press  Add> button to add a new warehouse, or
3. Select an already existing warehouse.

**Caution!** It is possible to use 'search record' option, you can search by name or by code.

### 30.19. Printouts

Printouts database contains all NON-STANDARD printouts. Each printout features a name, code and a template.



#### Procedure:

1. Enter  Databases> submenu and press  Printouts> entry.
2. Press  Add> button to add a new printout, or
3. Select an already existing record.

**Caution!** It is possible to use 'search record' option, you can search by name or by code.

### Designing new printout template

#### Procedure:

1. Enter  Databases> submenu and press  Printouts> entry.
2. Press  Add> button to create a new printout, or edit an already existing one.

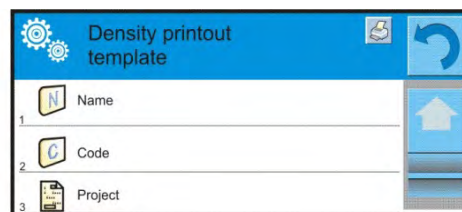
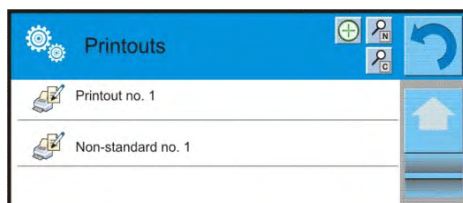

3. Edit box opens, press <Project> entry.
4. Respective box with an on-screen keyboard is displayed.
5. Use the keyboard and create printout template.

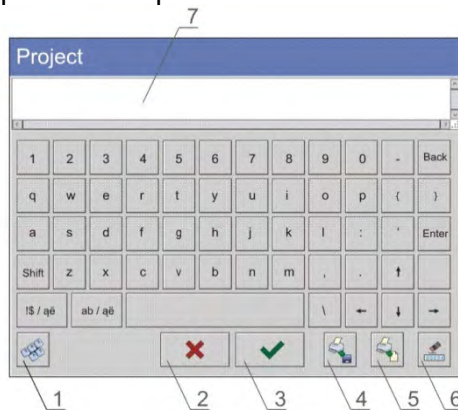

- 1 – zoom the edit box (7), recommended while using an external computer keyboard connected to balance's USB port,
  - 2 – cancel
  - 3 – confirm
  - 4 – download a printout template from a file
  - 5 – display list of variables
  - 6 – delete all printout content
  - 7 – edit box
6. Save designed printout.

**Caution!** To delete characters press Back key. To move cursor, press navigation keys.

### Example of Printout no. 1 – large edit box

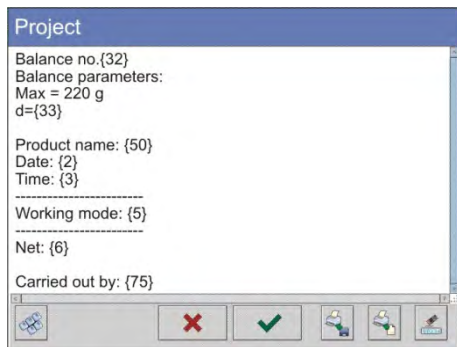

*Project*

Balance no. 400015  
 Balance parameters:  
 Max = 220 g  
 d= 0.001 g

Product name:  
 Date: 2011.10.24  
 Time: 11:48:06

-----  
 Working mode: Weighing

-----  
 Net weight: 94.147

Carried out by: Admin

*Printout template*

### Example of Printout no. 2 – printout from a file

All printout templates can be designed in a form of external files, that are imported to a balance; file extension: \*.txt or \*.lb. External file shall contain all constant and variable data. Upon importing, the content of a printout template can be modified.

#### Procedure:



1. Design a \*.txt or \*.lb file in an optional editor.
2. Copy the file to a USB flash drive.
3. Connect the USB flash drive to balance USB port.

4. Press [4] < Download a printout from a file> button.
5. Balance display shows data stored on the USB flash drive connected to the USB port.
6. Select file with printout template and press its name.
7. The printout template is automatically copied to an editing field.

### 30.20. Universal Variables

Universal Variables are alphanumeric data which can be combined with printouts, products or other comparison-related information. Each variable has to have its name, code and value specified.

#### Procedure:

1. Enter < Databases> submenu and press < **Var** Universal variables> entry.
2. Press < Add> button to add new variable, or
3. Select already existing universal variable, and modify the following fields: code, name, value.

**Caution!** It is possible to use 'search report' option.

### 30.21. Databases Management

Function allowing to manage databases data. It comprises three options: Export weighing database, Delete databases and Delete weighings and reports.

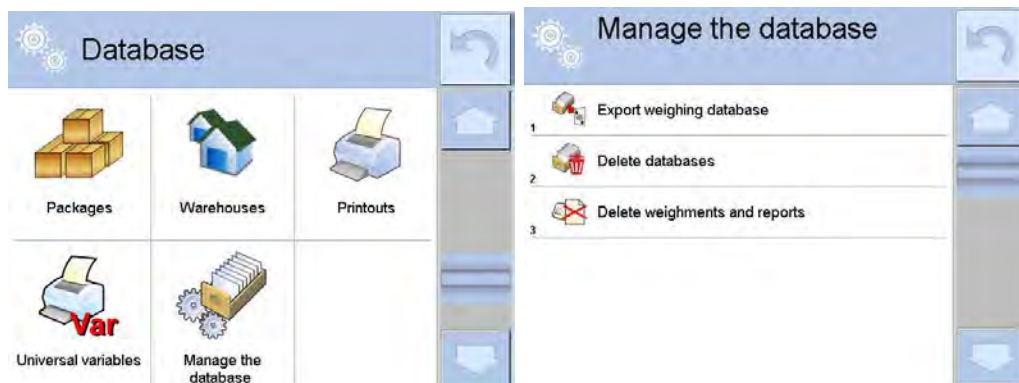

#### 30.21.1. Export Weighing Database to a File

All measurements are saved to a <Weighing records> database and can be exported to a file using a USB flash drive.

#### Procedure:

1. Connect the USB flash drive to USB port.
2. Press < Export weighing records database to a file> entry, a window for setting export options is opened.



3. <Data selection> parameter allows you to specify which data related to measurement is to be exported.



- Set respective data and press <Export weighing records database to a file> entry, weighing database is automatically exported.
- Upon export completion, message <Completed> is displayed along with information on number of exported data and with file name (with \*.txt extension). Next previous window is displayed.

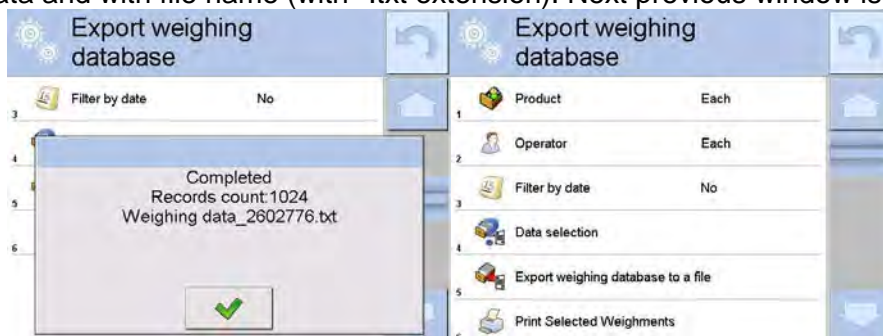

- You may return to a weighing procedure or proceed to other settings.

**Caution!** If balance software cannot identify the USB flash drive, then upon pressing <Export weighings database to a file> entry, <Operation failed> message is displayed.

- A name of created file consists of database name and balance serial number, e.g. <Weighing data\_364080.txt>.
- Unplug the USB flash drive from the USB port.

### Template of created file

The file is created in a form of table, columns of which are separated with <Tab>. This allows for direct export of the file to <Excel> spread sheet document. The table contains the following data: date and time, mass and mass unit, tare and tare unit, serial number, operator name, customer name, packaging name, source warehouse name, target warehouse name, control result name.

### 30.21.2. Delete Databases

Function allowing to delete data of selected database.

#### Procedure:

- Activate <Delete Databases> function, a window with databases list is displayed.
- Select a database, delete respective data.

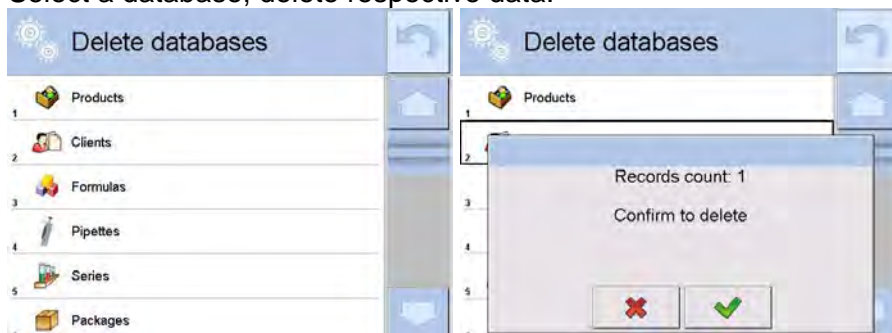

- Confirm, data is deleted, the following message is displayed:



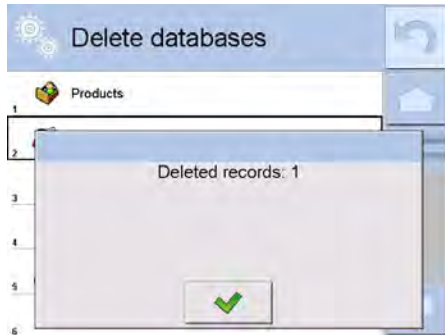

- Confirm, a previous window is displayed; you may continue weighing or proceed to other operations.

### 30.21.3. Delete Weighings and Reports

Function allowing to delete weighings and reports of a given database.

#### Procedure:

- Activate <Delete weighing records and reports> parameter, a window with a numeric keyboard is displayed.
- Enter a date specifying which data is to be removed.
- Date is given in the following form: year-month-day.

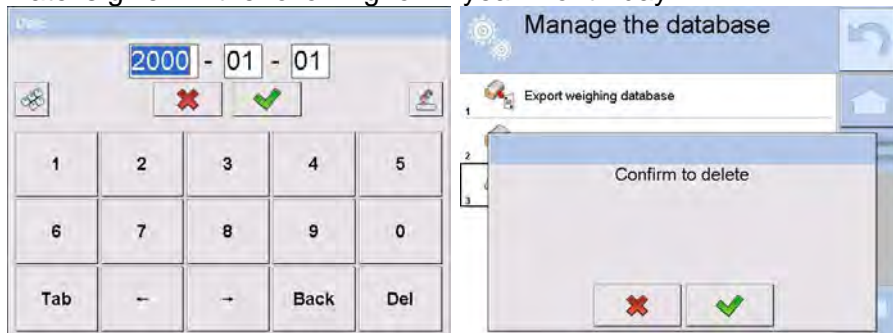

- Confirm the date, all weighings and reports older than those specified by the date are removed.
- Quantity of deleted weighings and reports is displayed.



## 31. COMMUNICATION

Communication menu is located in <Parameters> menu. To access communication menu press 'Setup' key or <Setup> quick access button. Communication between the balance and the peripheral devices is established via the following ports:



-  COM 1 (RS232),
-  COM 2 (RS232),
-  Ethernet,
-  Wi-Fi,
-  TCP.

The ports are to be configured in <  Communication> parameter.

To enter <  Communication> parameter, press  key, next select <  Communication> entry.

### 31.1. RS232 Ports Settings

#### Procedure:

1. Select communication port <  COM1> or <  COM2>.
2. Set respective parameters.
  - Baud rate: 4800, 9600, 19200, 38400, 57600, 115200 bit/s
  - Data bits: 5, 6, 7, 8
  - Stop bits: None, 1, 1.5, 2
  - Parity: None, Odd, Even, Marker, Space

### 31.2. ETHERNET Port Settings

#### Procedure:

1. Select communication port <  Ethernet>.
2. Set respective parameters
  - DHCP: Yes – No
  - IP Address: 192.168.0.2
  - Subnet mask: 255.255.255.0
  - Default gate: 192.168.0.1

**Caution!** The above presented values serve informative purposes only. Set the transmission parameters in accordance with your local network.

3. Press  button, the message <Restart balance to implement changes> is displayed.
4. Return to weighing procedure and restart the weighing device.

### 31.3. Wi-Fi Settings

Balance equipped with Wi-Fi module displays respective pictogram:

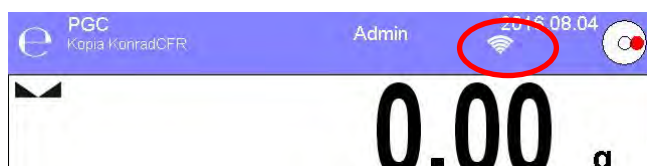

#### Procedure:

1. Select <  Wi-Fi> communication interface.
2. Set respective parameters:
  - DHCP: Yes – No
  - IP Address: 10.10.9.155
  - Subnet mask: 255.255.255.0
  - Default gate: 10.10.8.244

**Caution!** The above presented values serve informative purposes only. Set the transmission parameters in accordance with your local network.

3. Press  button, the message <Restart balance to implement changes> is displayed.
4. Return to weighing procedure and restart the weighing device.

You may use <Available networks> parameter to view the list of networks detected by the module:



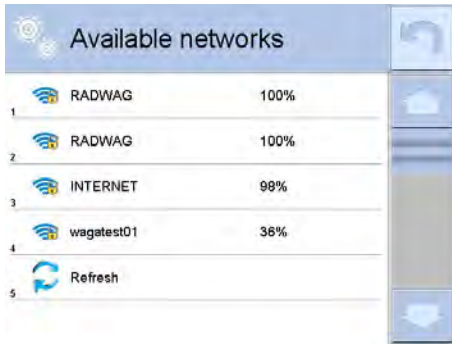

Pictogram with a padlock means that the password is required. Press <Refresh> pictogram to search for available networks.

Press <Network status> field to check selected network parameters.

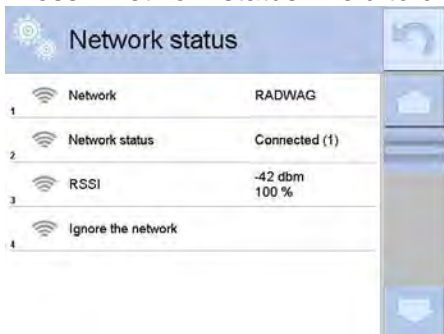

The selected network and connection parameters are saved to balance memory. The program connects to the network in accordance with the memory-saved parameters each time the balance is switched on. To change this, select <Forget network> option. Given network gets disconnected.

### 31.4. TCP Settings

TCP (*Transmission Control Protocol*) is a stream protocol, operating in customer-server mode, enabling communication between two computers. You can establish connection on specified server port.

#### Procedure:

1. Enter < Communication > parameter.
2. Select < TCP / Port >; a <Port> window with on-screen keyboard is opened.
3. Insert required port number and press button to confirm.

## 32. PERIPHERALS

<Peripherals> menu is located in <Parameters> menu. To access <Peripherals> menu press Setup key or < Setup > quick access button. Peripherals menu provides list of devices that can cooperate with the balance.

### 32.1. Computer

Active 'balance' – 'computer' connection is signalled by pictogram (top bar of the home screen). < Computer > submenu enables connection configuration.

#### Procedure:

1. Press key and next press < Peripherals/ Computer >.
2. Set balance-computer cooperation parameters:
  - Computer port

Available options: none, COM 1, COM 2, TCP.

- Address  
Give address of balance connected to a computer.
- Continuous transmission  
Available options: NO, YES (printout format is conditioned by set weighing printout template – see parameter below).
- Interval  
Parameter enabling you to set frequency of printouts for continuous transmission.  
Frequency of printouts is set in seconds, wherein the accuracy is 0.1s.  
Time values range between 0.1 and 1000 s. Interval setting is valid for continuous transmission activated using balance and computer.
- Weighing printout template  
Parameter enables printout customization to be carried out in a window with printout template (for detailed information about creating printouts refer to section 30.19 of this user manual).
- E2R System  
E2R is a supervision and control system designed to monitor all weighing processes carried out on a balance, with E2R system activated some databases can be operated using computer exclusively (access to specified functions and options using weighing instrument is not possible).

**Caution!**  *E2R System* can only be activated by balance manufacturer or by authorized personnel. Turn the continuous transmission off in order to provide correct cooperation with E2R system.

## 32.2. Printer

<Printer> submenu allows you to:

- set port for establishing communication with a printer,
- define printer's code page (by default: 1250),
- define control codes for PCL printer or EPSON receipt printer.  
**Caution: Codes must be entered in a hexadecimal form!**
- define printout templates.

To ensure correct cooperation of the balance with the printer (correct printout of diacritical signs of a given language), respective baud rate, obligatory for a given printer, must be chosen (see the printer settings). Additionally code page of a sent printout must be accordant with a code page of a printer.

There are two methods for obtaining code page accordance:

- by setting the right code page in printer settings (read the printer manual) – respective to printout code page set in a balance; or
- by sending control code, from a balance to the printer, which automatically sets the right code page (respective to code page set in a balance) in advance before execution of the data printout – it is possible only for printers equipped with such option.

Exemplary balance settings for correct cooperation (printout of Polish signs) with EPSON thermal printer connected to RS232 port:

### 1. EPSON TM-U220x dot matrix printer

*Communication parameters for port to which the printer is connected:*

- baud rate                   9600 bit/s
- data bits                    8
- stop bits                    1
- parity                        none

*Printer parameters set for PERIPHERALS group:*

- port                         COM 1 or COM 2 (the one to which the printer is connected)
- code page                 **852**
- control codes             **1B7412**

### 2. EPSON TM-T20 thermal printer

*Communication parameters for port to which the printer is connected:*

- baud rate 38400 bit/s
- data bits 8
- stop bits 1
- parity none

*Printer parameters set for PERIPHERALS group:*

- port COM 1 or COM 2 (the one to which the printer is connected)
- code page **1250**
- prefix **1B742D**

*Printer parameters set for PERIPHERALS group:*

- port COM 1 or COM 2 (the one to which the printer is connected)
- code page **852**
- control codes **1B7412**

If there are any unexpected signs on the printout in the place of the last digit (for verified balances), then <CONTROL CODES> parameter must incorporate, apart from the code page, code of the UK signs chart: **1B5203**. In such case the <CONTROL CODES> parameter is set as follows: control codes – **1B74121B5203**

A printout template describes how to print information from databases. The template can be modified. In order to check format of printout template, print data related to e.g. product parameters. To do it go to <Products/Edit product> submenu and press printer pictogram.

Default values for particular templates:

Product printout template	{50}
	{51}
Operator printout template	{75}
	{76}
Customer printout template	{85}
	{86}
Warehouse printout template	{130}
	{131}
Package printout template	{80}
	{81}
	{82}

Ambient conditions printout template

----- Ambient Conditions-----

Date and time	{275}
Temperature of sensor 1:	{value} °C
Temperature of sensor 1:	{value} °C
THBS temperature:	{value} °C
THBS humidity:	{value} %

-----

Formulation printout template

----- Formulation -----

Formulation name:	{165}
Ingredients quantity:	{167}
Target mass:	{168} g
Formulation ingredients:	{169}



-----

### 32.3. Barcode Scanner

The balance enables cooperation with a barcode scanner. The barcode scanner is used to facilitate quick search for database records:

- Products,
- Operators,
- Customers,
- Packages,
- Warehouses,
- Formulations,
- Pipettes
- Series in a differential weighings
- Universal variables,

To configure barcode scanner enter:



„ /  **Peripherals** /  **Barcode scanner**”.

#### **Caution!**

Enter  <Communication> submenu and set baud rate for a barcode scanner (by default 9600b/s). For detailed description of 'balance' - 'barcode scanner' communication read APPENDIX E of this user manual.

#### 32.3.1. Barcode Scanner Port





##### **Procedure:**

1. Enter < **Peripherals**> parameter.
2. Go to „ **Barcode scanner** /  **Port**” parameter.
3. Select respective option.

Ports for 'balance' – 'scanner' communication:

- RS 232 (COM1),
- RS 232 (COM2),
- USB

#### 32.3.2. Prefix/Suffix







You can edit <  **Prefix**> and <  **Suffix**> to synchronize balance program with barcode scanner.

##### **Caution:**

In RADWAG-adopted standard, the prefix is 01 sign (byte) hexadecimal format, the suffix is 0D sign (byte) hexadecimal format.

For detailed description of 'balance' - 'barcode scanner' communication read **APPENDIX E** of this user manual.

##### **Procedure:**











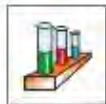

1. Enter < Barcode scanner> submenu,
2. Select <  **Prefix**> parameter and enter hexadecimal value using the on-screen keyboard. Press  button to confirm.
3. Select <  **Suffix**> parameter and enter hexadecimal value using the on-screen keyboard. Press  button to confirm.

### 32.3.3. Field Selection







Parameter allowing you to specify, for which field the search is to be carried out in particular databases.

#### Procedure:

1. Enter  **Peripherals** submenu,
2. Select „  **Barcode scanner** /  **Field selection**”. List of fields is displayed:

	Product		Series
	Operator		Universal variable 1
	Customer		Universal variable 2
	Packaging		Universal variable 3
	Warehouse		Universal variable 4
	Formulation		Universal variable 5
	Pipette		

3. Select one item from the list. The following parameters may be edited:

	<b>Filtering</b>	Parameter allowing you to declare search criteria (see table below)
	<b>Offset</b>	Parameter allowing you to set the first significant code's character, characters preceding the first significant character are skipped during comparison search.
	<b>Code length</b>	Parameter allowing you to set the number of code's characters to be taken into account during search procedure.
	<b>Start marker</b>	Parameter allowing you to declare the starting point of scanned code, taken into account during the search.
	<b>End marker</b>	Parameter allowing you to declare the ending point of scanned code, taken into account during the search.
	<b>Ignore marker</b>	Parameter allowing you to determine whether start and end markers are to be referred to or skipped during comparison of scanned code with the code saved to the balance.

#### Filtering criteria conditioned by field type:



Field selection	Filtering
Product	None, Name, Code, EAN code

Operator	None, Name, Code,
Customer	None, Name, Code,
Packaging	None, Name, Code,
Warehouse	None, Name, Code,
Formulation	None, Name, Code,
Pipette	None, Name, Code,
Series	None, Name, Code,
Universal Variables	None, Active

### 32.3.4. Test

 **Test** parameter allows you to verify if operation of a barcode scanner connected to a balance is correct.

#### Procedure:

1. Enter  Barcode scanner> submenu,
2. Select  Test> parameter; <Test> edit box is displayed, it features ASCII and HEX fields.
3. The code is scanned and entered to the ASCII field and HEX field, next the test result is displayed in the bottom part.

#### When:

- **<Prefix>** and **<Suffix>** declared in balance settings comply with <Prefix> and <Suffix> of the scanned code, the test result is **<Positive>**,
- **<Prefix>** and **<Suffix>** declared in balance settings do not comply with <Prefix> and <Suffix> of the scanned code, the test result is **<Negative>**.

## 32.4. Transponder Card Reader

You can log in to the balance by means of:

- password entered using an on-screen keyboard,
- registered transponder card scanner.

#### Caution!

For correct 'balance' - 'transponder card reader' cooperation set appropriate baud rate value in  Communication> submenu (by default: 9600b/s).



### Transponder card reader port

Communication between the weighing device and the transponder card reader can be established via the following ports:

- RS 232 (COM1)
- RS 232 (COM2)

In order to enable operator to log in via a transponder card reader, first it is necessary to assign a number of an already registered card to the selected operator (database of operators).

#### Procedure:

1. Connect a transponder card reader to a given port (RS 232 COM1 or RS 232 COM2), select communication port for 'balance' – 'transponder card reader' communication.
2. Go to a  Communication> submenu and set baud rate compatible with baud rate of the transponder card reader (by default: 9600b/s).
3. Enter operators database, edit given operator's record, and go to  Card no.> parameter.
4. <Card no.> edit box with an on-screen keyboard is displayed.

5. Approximate the card to the transponder card reader. The program automatically displays number of detected card in the <Card no.> box.
6. Press  button to confirm and return to the weighing.





### 32.5. Additional Display

Communication between the weighing device and the additional display can be established via the following ports:

- RS 232 (COM1)
- RS 232 (COM2)
- TCP

Type of data displayed on an additional display is declared in <Project> variable.

#### Procedure – designing a variable:

1. Enter < Peripherals> submenu.
2. Select < Additional display/ Project> parameter, a <Project> edit box with an on-screen keyboard is displayed.
3. Use the on-screen keyboard to insert desired value of a project, or press < > button and select respective value from the list.
4. Press  button to confirm.

**Caution!** The balance cooperates with RADWAG WD5/3Y additional display. In order to ensure correct cooperation between the balance and the additional display, set {140} variable for < Project> parameter, next set 38400 bits/s baud rate for a port to which the additional display is connected.

### 32.6. Ambient Conditions Module

Ambient conditions module (THB) can be connected to the balance via COM 1 or COM 2 port. In order to provide correct cooperation enter module's address and baud rate for the port (port settings) to which the ambient conditions module is connected (the address and baud rate are to be found on an ambient conditions data plate).

### 32.7. Automatic Feeder

*(function disabled for standard balance models)*

Communication between the weighing device and the automatic feeder can be established via the following ports:

- RS 232 (COM1)
- RS 232 (COM2)
- Com internal.

To ensure correct cooperation with the feeder, set its address (the address and baud rate are to be found on an automatic feeder data plate).

## 33. INPUTS / OUTPUTS

Inputs are used to control balance operation. 4Y is equipped with inputs. Each input can be assigned with the following functions or buttons:

- |                            |              |
|----------------------------|--------------|
| • Checkweighing thresholds | • Right door |
| • Target value             | • Parameters |
| • Profile                  | • Statistics |







- Adjustment
- Zero
- Tare
- Set tare
- Disable tare
- Restore tare
- Packaging
- Print
- Header printout
- Footer printout
- Universal variable 1 ÷ 5
- Accept
- Abort
- Operator
- Left door
- Add to statistics
- Product
- Warehouse
- Customer
- Parts counting: Set part mass
- Parts counting: Determine part mass
- Percent weighing: Set reference mass
- Percent weighing: set 100%
- Solid density
- Liquids density
- Air density
- Automatic Weight Crane Control
- Task
- Reference weight
- 

Upon change of the logic state of the input system, e.g. from [0] to [1], a function that is assigned to the system is carried out. For instance:

- automatic balance adjustment,
- display of set checkweighing threshold values,
- restoring tare value.

**Procedure:**





1. Press  key, next press:  <Inputs/Outputs> button.
2. Enter  <Inputs/Outputs> submenu and select  <Inputs> parameter.
3. Edit a selected input; list of available functions is displayed.
4. Select a given function and return to weighing.

Outputs are used to SIGNAL weighing state. The logic state of the output system switches, e.g. from [0] to [1], when condition assigned to the output is met.



Each of the 4 outputs can be assigned with the following functions:

None	-----
Stable	Each stable measurement switches the logic state.
MIN stable.	Stable measurement below [MIN] threshold switches the logic state.
MIN unstable	Unstable measurement below [MIN] threshold switches the logic state.
OK stable	Stable measurement within [MIN] [MAX] thresholds switches the logic state.
OK unstable	Unstable measurement within [MIN] [MAX] thresholds switches the logic state.
MAX stable	Stable measurement above [MAX] threshold switches the logic state.
MAX unstable	Unstable measurement above [MAX] threshold switches the logic state.
Cycle completion confirmation	End of procedure.

## Procedure:



1. Press  key, next press:  button.
2. Enter    parameter.
3. Edit a selected output; list of available functions is displayed.
4. Select given function from the list, next return to weighing and save changes.

## 34. MISCELLANEOUS PARAMETERS

This menu contains parameters facilitating balance operation. To enter <Misc.> submenu, press  key, next press  Misc.> button.

### 34.1. Interface Language

#### Procedure:



1. Enter  Misc.> submenu.
2. Select  Language> parameter and set language.

Available languages: Polish, English, German, French, Spanish, Korean, Turkish, Chinese, Italian, Czech, Romanian, Hungarian, Russian.

### 34.2. Date and Time

You can set date, time and their formats.





There are two ways to edit date and time settings:

- Press **<Date and time>** entry (home screen's top bar).
- Go to  /  Misc./  Date and time> parameter.

#### Procedure:

1. Enter date and time settings, an on-screen keyboard is displayed.
2. Set date and time: year, month, day, hour, minute.
3. Press  button to confirm.

Additional functions of  /  Misc./  Date and time> submenu:

Pictogram	Name	Value	Description
	Time zone	(UTC+01:00) Sarajevo, Skopje, Warsaw, Zagreb	Parameter value: name of time zone/country. Particular name contains information regarding summer/winter time change. The information comes from Microsoft website.
	Automatically adjust clock for daylight saving	Yes	Function enables or disables automatic clock adjustment. Upon parameter change restart the balance.
	Date and time	2016.04.04 08:00:00	Enter this parameter to set internal clock and date.
	Date format	yyyy.MM.dd *	Enter this parameter to select date format. Available values: d.M.yy, d/M/yy, d.M.yyyy, dd.MM.yy, dd/MM/yy, dd-MM-yy, dd.MMM.yyyy, dd/MM/yyyy, dd-MMM-yy, dd.MMM.yyyy, M/d/yy, M/d/yyyy, MM/dd/yy, MM/dd/yyyy, yy-M-dd, yy/MM/dd, yy-MM-dd, yyyy-M-dd, yyyy.MM.dd, yyyy-MM-dd.

	Time format	HH:mm:ss **	Enter this parameter to select time format. Available values: H.mm.ss, H:mm:ss, H-mm-ss, HH.mm.ss, HH:mm:ss, HH-mm-ss, H.mm.ss tt, H:mm:ss tt, H-mm-ss tt, HH.mm.ss tt, HH:mm:ss tt, HH-mm-ss tt, h.mm.ss tt, h:mm:ss tt, h-mm-ss tt, hh.mm.ss tt, hh:mm:ss tt, hh-mm-ss tt
---	-------------	-------------	--

\*) - For date format: y – year, M – month, d – day

\*\*\*) - For time format: H – hour, m – minute, s – second

<  Date and time> parameter enables preview of declared date and time formats.

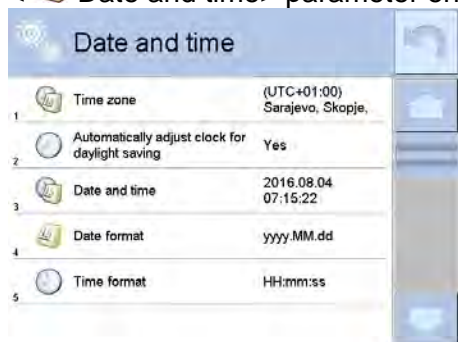



**Caution!**

<  Date and time> parameter can be accessed only by an operator with appropriate permissions. Permissions level can be modified by administrator in <Permissions> menu.

### 34.3. „Beep” Sound

**Procedure:**



1. Enter <  Misc.> submenu.
2. Select <  Beep> parameter.
3. Set appropriate value:

None	Beep sound disabled for keys/buttons and proximity sensors.
Keys/Buttons	Beep sound enabled for keys/buttons.
Sensors	Beep sound enabled for proximity sensors.
All	Beep sound enabled for keys/buttons and proximity sensors.

### 34.4. Volume

You can change volume of the loudspeaker mounted in the weighing indicator.



**Procedure:**

1. Press  key, next go to <  Misc./Volume> submenu. An on-screen keyboard is displayed.
2. Enter volume in percent: 100% - maximum volume, 0% - minimum volume (loudspeaker off).

### 34.5. Sleep Mode

You can turn on display sleep mode.

**Procedure:**



1. Press  key, next go to <  Misc./Display sleep mode> submenu.
2. Select one of the following options: [None; 1; 2; 3; 5; 10; 15]. Digits stand for minutes.
3. The software returns to the previous menu.

**Caution!** Display turns to sleep mode only when the balance is not operated (the indication on the screen remains the same). Upon mass change, or pressing any key on the panel, the balance returns to weighing.

### 34.6. Display Brightness

Display brightness influences duration of battery-powered balance operation. The brighter the screen, the shorter operation time. To make the balance work longer, reduce screen brightness.



#### Procedure:

1. Press  key, next go to  Misc./Display brightness> submenu.
2. Enter desired value: [0% - 100%]. Display brightness changes automatically, the previous menu is displayed.

### 34.7. Touch Panel Calibration

Display calibration is required if the touch panel does not react correctly during operation.

#### Procedure:

1. Enter  Misc.> submenu.
2. Select  Touch panel calibration> parameter, an edit box is displayed.
3. Use finger or a thin, soft stylus to press and hold a display area with a cross. After pressing the fifth cross in order, accept the changes by pressing  key.

**Caution!** The process can be aborted by pressing Esc key on an external keyboard connected to the balance indicator.

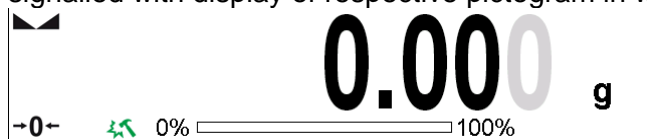

### 34.8. Vibrations Detection

The program detects incorrect loading of the weighing pan with the sample. Incorrectness with regard to loading can lead to increased indication errors. Activation of 'Vibrations detection' function is signalled with display of respective pictogram in weighing result window.



If incorrectly carried out loading is detected, the pictogram turns to red . The measurement result may be affected by a greater error.

#### Procedure:



1. Enter  <Misc.> submenu.
2. Select  Vibrations detection> parameter.
3. Select one of available options:
  - Yes – function on
  - No – function off

### 34.9. Level Control

The balance is equipped with Automatic Level Control mechanism. You can define its operation for non-verified devices.

In case of verified instruments, the settings are hidden and the balance operates in accordance with factory settings, i.e. <Active with lock>. Weighing process is possible only if balance is properly levelled.

**Procedure:**

1. Enter < Misc.> submenu.
2. Select < Level control> parameter, an edit box is displayed.
3. Select one of available options:
  - None – level indicator not displayed, the balance does not control level status,
  - Active – level indicator displayed, level status is signalled by colour (green→ OK, red→ levelling required),
  - Active with lock – level indicator displayed, level status is signalled by colour (green→ OK, red→ levelling required). For red level indicator 'no Level' alert is displayed - weighing function is blocked.

**Caution!** For detailed information on levelling read section 10.3 of this user manual.

**34.10. Proximity Sensors Sensitivity**

Parameter allowing you to change sensitivity of the proximity sensors, the values range between 0 - 9.  
By default it is 5 - 7.



**Procedure:**

1. Enter < Misc.> submenu.
2. Select <Proximity sensors sensitivity> parameter, an edit box is displayed.
3. Select one of available options.

**34.11. Proximity Sensors Timeout**

Parameter for setting timeout of proximity sensors expressed in [ms].  
Default value: <0>.  
When you use the option of motion recognition, set <Proximity sensors timeout> parameter to <500ms> value.

**Procedure:**

1. Enter < Misc.> submenu.
2. Select <Proximity sensors timeout> parameter, an on-screen keyboard is displayed.
3. Enter <500> value.
4. Confirm. Menu is displayed.

**34.12. Autotest**



<AUTOTEST> function has been designed to help you assess balance operation and to diagnose the cause of weighing errors exceeding the maximum permissible values.

AUTOTEST facilitates regular optimisation of balance settings which is necessary in order to maintain the best possible repeatability and weighing time at the workstation. The function allows you to monitor the parameters at optional moment and save records from carried out tests.

- There are two modules:
- AUTOTEST FILTER;
  - AUTOTEST GLP.

Prior each test the balance controls level status, temperature and humidity.



### AUTOTEST FILTER

Procedure consisting in loading and unloading of the internal weight for all possible 'filter' and 'value release' settings, the test requires 10 repetitions. It controls 2 parameters: 'Repeatability' and 'Stabilization time'.

The test takes approximately 1 hour. Upon completion, information regarding results is obtained. Optimum settings for particular ambient conditions are provided.

Autotest Filter enables:

- to obtain the highest measurement repeatability and the shortest measurement time with acceptable value of repeatability; test results are stored in balance memory until it is turned off,
- test results printout,
- direct and fast selection of optimal parameters.

Upon completed autotest, a summary with results is displayed.

Information regarding filters settings is provided automatically via display of respective pictograms: settings providing the fastest measurement (the shortest measurement time).



settings providing the most accurate measurement (the lowest possible value of deviation for 10 measurements).

settings providing optimal measurement (the lowest value of time and deviation product).

current settings for filters.

Measurement results:

- \*Filter type.
- \*<Value release> parameter value.
- \*Repeatability of indications expressed as standard deviation.
- \*Average time of measurement stabilization.

Example of Autotest Filter results:

Autotest Filter		
3	Very fast Reliable	0.0010 g 3.650 s
4	Fast Fast	0.0005 g 1.536 s
5	Fast Fast and reliable	0.0005 g 2.038 s
6	Fast Reliable	0.0004 g 3.181 s
7	Normal Fast	0.0005 g 2.393 s
8	Normal Fast and reliable	0.0011 g 2.881 s

Autotest Filter		
4	Fast Fast	0.0005 g 1.536 s
5	Fast Fast and reliable	0.0005 g 2.038 s
6	Fast Reliable	0.0004 g 3.181 s
7	Normal Fast	0.0005 g 2.393 s
8	Normal Fast and reliable	0.0011 g 2.881 s
9	Normal Reliable	0.0005 g 4.073 s

You can quickly modify 'filter' and 'value release' settings. To do that, select results for particular settings that are to be saved. Press <Activate>.



### Report example:

----- Autotest Filter: Report -----

Balance type           XA 4Y  
 Balance S/N           442566  
 Operator               Hubert  
 Software ver.         NL1.6.5 S  
 Date                   2015.05.07  
 Time                   09:34:48

-----  
 Reading unit           0.0001/0.0001 g  
 Internal weight mass   148.9390 g  
 Temperature: Start    25.26 °C  
 Temperature: Stop     25.66 °C  
 -----

Filter                   Very fast  
 Value release          Fast  
 Repeatability          0.0042 g  
 Stabilization time     4.505 s

.  
 .  
 .

Filter                   Very slow  
 Value release          Reliable  
 Repeatability          0.0207 g  
 Stabilization time     5.015 s

Signature

-----

### Procedure:

1. Activate 'Autotest Filter' function, the process starts automatically. Progress bar is displayed.
2. Wait for process completion, a summary is displayed, current filter settings are provided. The report can be printed.

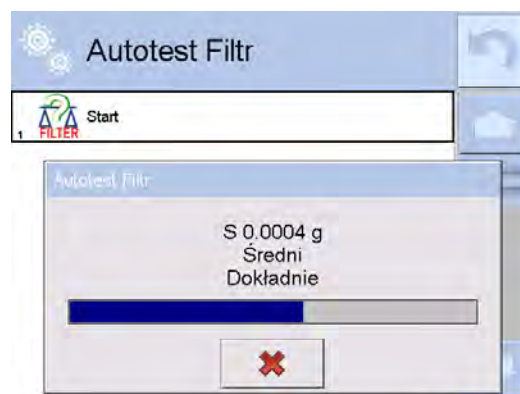



You can abort the process at any moment. To do that press <X> button.



### AUTOTEST GLP

Autotest GLP is a test of repeatability of internal weight loading and determination of indication error, which error is referred to balance maximum capacity.

#### Procedure:

1. deposit internal weight twice, next deposit internal weight ten times,
2. adjust the balance,
3. calculate and record the value of standard deviation,
4. In balance with automatically opened doors, door opening and closing test is carried out.

Autotest GLP function enables:

- Report display and printout,
- Record of a report containing basic balance data, ambient conditions values and test results.
- 

Test results:

- \*Deviation for maximum capacity.
- \*Value of repeatability expressed as standard deviation.
- \*Door test result (positive / negative).

#### Report example:

```
.....
----- Autotest GLP: Report -----
Balance type           XA 4Y
Balance S/N           400010
Operator              Admin
Software version      L0.0.21 S
Date                  2012.01.16
Time                  09:17:16
-----
Measurements quantity  10
Reading unit          0.0001 g
Internal weight mass   140.094 g
Filter                Average
Value release         Fast and precise
-----
Deviation for Max.    -0.0118 g
Repeatability         0.00088 g
Signature
.....
```

#### Procedure:

1. Press entry with test name, a message box is displayed.
2. Do one of the following:
  - Start subsequent AUTOTEST GLP process,
  - Preview results of completed autotests, and export all saved test results as file with \*.csv extension,
  - Delete all saved test results.

You can abort the process at any moment by pressing <X> button.

Results of carried out autotests are displayed in a table (each line features date and time of autotest procedure and its result).

To preview particular autotest data, press a respective table line.

In order to print a result of a single autotest, enter its details (see above) and generate a printout by pressing <Print> key located on the top of the display.

Autotest results can be exported by pressing <Export> entry in the window with all saved reports. Data is sent to a USB flash drive, connected to balance USB port, as a file with \*.csv extension.

### 34.13. Start-Up Logo

*(option enabled only for authorized operators)*

The parameter enables you to change logo that is displayed on balance start-up.

### 34.14. Export of System Events

*(option enabled only for authorized operators)*

The parameter enables you to generate a special type of a file that is automatically saved to a USB flash drive, plugged to USB port. The file helps RADWAG service to diagnose cause of problems occurring during balance operation.

#### Procedure:

1. Plug a USB flash drive to mass comparator's USB port.
2. Enter < Misc.> submenu.
3. Select <Export system events> parameter.
4. The software generates a file and automatically saves it on the USB flash drive.
5. The generated file has to be sent to RADWAG.

## 35. UPDATE

Update function enables update of:

- Help files available from the operator level.
- Application.
- Metrological parameters: main board (administrator exclusively).

Update takes place automatically by loading data from a USB flash drive connected to balance USB port.

#### Procedure:

1. Prepare a USB flash drive with update file. Required file extension: \*.lab2.
2. Connect the USB flash drive to balance USB port.
3. Select <Application> entry.
4. The display previews content of the USB flash drive, search for the update file and press its name.
5. Updating proceeds automatically.

Update of help files and the main board file is analogous; required files extensions are: \*.hlp - help, \*.mbu – main board.

## 36. ABOUT (system info)

'About' menu provides information on balance and balance program. Most of parameters in this menu are for the information purpose only.

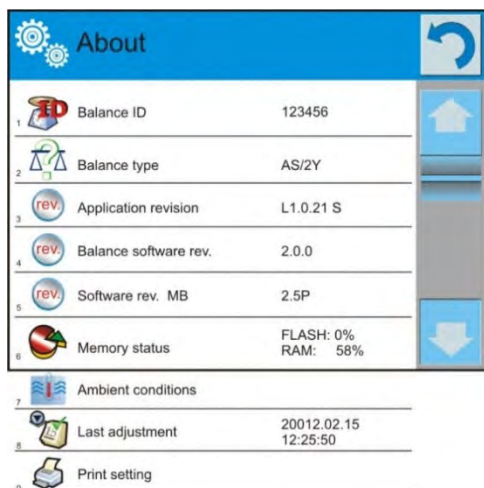

<Ambient conditions> parameter enables preview of present ambient conditions: temperature, humidity, pressure (if the balance features ambient conditions sensors).

<Print settings> parameter enables you to send all parameters to printer port.

### 37. VIDEOS

Videos menu enables display of instruction videos (\*.wmv) presenting how to operate the balance. Administrator can add/delete videos. Remaining operators may only watch the videos stored in the balance memory.

**To add a video follow the below procedure:**

1. Save the video on a USB flash drive.
2. Plug the drive to the USB port.
3. Enter <Videos> menu.
4. Press <+> button.
5. Select respective file.
6. The video is saved to the balance memory.



**To play the video follow the below procedure:**



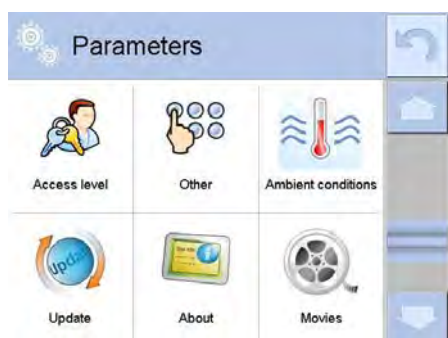



1. Save the video to the balance memory (see instruction above).
2. Enter <Videos> menu.
3. Press the name of a video to be played.

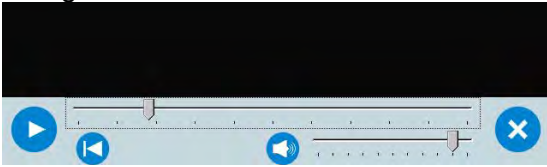

4. The video starts automatically.

Navigation buttons:



 	Play/ Pause
	Stop
	Increase/decrease the volume (volume power adjusted, for settings go to <Misc.> menu).
 	Sound on/off.
	Restart.

## 38. COMMUNICATION PROTOCOL

### General Information

- A. A character based communication protocol (balance-indicator) is designed for establishing communication between a RADWAG balance and a peripheral device via RS-232C interface.
- B. The protocol consists of commands sent from a peripheral device to the balance and responses from the balance.
- C. Responses are sent from the balance each time a command is received.
- D. Commands, forming the communication protocol, enable obtaining data on balance status and facilitate influencing balance operation, e.g.: acquiring measurement results from the balance, zeroing, etc.

### 38.1. List of Commands

Command	Command overview
<b>Z</b>	Zero balance
<b>T</b>	Tare balance
<b>OT</b>	Give tare value
<b>UT</b>	Set tare
<b>S</b>	Send stable measurement result in basic measuring unit
<b>SI</b>	Immediately send measurement result in basic measuring unit
<b>SIA</b>	Immediately send measurement results from all weighing platforms in basic measuring units
<b>SU</b>	Send stable measurement result in current measuring unit
<b>SUI</b>	Immediately send measurement result in current measuring unit
<b>C1</b>	Switch on continuous transmission in basic measuring unit
<b>C0</b>	Switch off continuous transmission in basic measuring unit
<b>CU1</b>	Switch on continuous transmission in current measuring unit
<b>CU0</b>	Switch off continuous transmission in current measuring unit
<b>DH</b>	Set min checkweighing threshold
<b>UH</b>	Set max checkweighing threshold
<b>ODH</b>	Give value of min checkweighing threshold
<b>OUH</b>	Give value of max checkweighing threshold
<b>SM</b>	Set mass value of a single item
<b>TV</b>	Set target mass value
<b>RM</b>	Set reference mass value
<b>NB</b>	Give balance serial number
<b>PROFILES</b>	Set balance profile
<b>PRG</b>	Give profile name
<b>LOGIN</b>	User logging
<b>LOGOUT</b>	User logout
<b>SS</b>	Value release
<b>IC</b>	Internal adjustment performance

<b>IC1</b>	Disable automatic internal adjustment of the balance
<b>IC0</b>	Enable automatic internal adjustment of the balance
<b>K1</b>	Lock balance keypad
<b>K0</b>	Unlock balance keypad
<b>BP</b>	Activate sound signal
<b>OMI</b>	Give available working modes
<b>OMS</b>	Set working mode
<b>OMG</b>	Give current working mode
<b>PC</b>	Send all implemented commands
<b>BN</b>	Give balance type
<b>FS</b>	Give max capacity
<b>RV</b>	Give program version
<b>A</b>	Set AUTOZERO function
<b>EV</b>	Set ambient conditions state
<b>EVG</b>	Give set ambient conditions
<b>FIS</b>	Set filter
<b>FIG</b>	Give set filter
<b>ARS</b>	Set value release
<b>ARG</b>	Give set value release
<b>LDS</b>	Set last digit
<b>UI</b>	Give accessible units
<b>US</b>	Set unit
<b>UG</b>	Give current unit
<b>NT</b>	Cooperation with PUE 7.1, PUE 10 indicators

**Caution:**

Each command must end with CR LF characters.

**38.2. Response Format**

On receipt of a command, the indicator responds as follows:

XX_A CR LF	command understood and in progress
XX_D CR LF	command carried out (appears only after the XX_A command)
XX_I CR LF	command understood but not accessible at this moment
XX _ ^ CR LF	command understood but max threshold is exceeded
XX _ v CR LF	command understood but min threshold is exceeded

XX _ OK CR LF	command carried out
ES_CR LF	command not recognised
XX _ E CR LF	time limit exceeded while waiting for stable measurement result (time limit is a characteristic balance parameter)

**XX** - stands for a name of a sent command  
 \_ - space

## COMMANDS OVERVIEW

### Zero Balance

Format: **Z CR LF**

Response options:

- Z\_A CR LF - command understood and in progress
- Z\_D CR LF - command carried out
- Z\_A CR LF - command understood and in progress
- Z\_^ CR LF - command understood but zeroing range is exceeded
- Z\_A CR LF - command understood and in progress
- Z\_E CR LF - time limit exceeded while waiting for stable measurement result
- Z\_I CR LF - command understood but not accessible at this moment

### Tare Balance

Format: **T CR LF**

Response options:

- T\_A CR LF - command understood and in progress
- T\_D CR LF - command carried out
- T\_A CR LF - command understood and in progress
- T\_v CR LF - command understood but taring range is exceeded
- T\_A CR LF - command understood and in progress
- T\_E CR LF - time limit exceeded while waiting for stable measurement result
- T\_I CR LF - command understood but not accessible at this moment

### Give Tare Value

Format: **OT CR LF**

Response: **OT\_TARE CR LF** - command carried out

Response format:

1	2	3	4-12	13	14	15	16	17	18	19
O	T	space	tare	space	unit			space	CR	LF

**Tare** - 9 characters, right justification

**Unit** - 3 characters, left justification

**Caution:**

*Tare value is always given in an adjustment unit.*

### Set tare

Format: **UT\_TARE CR LF**, where **TARE** - tare value

Response options:



- UT\_OK CR LF - command carried out
- UT\_I CR LF - command understood but not accessible at this moment
- ES CR LF - command not recognised (tare format incorrect)

**Caution:**

Use dot in tare format as decimal point.

**Send stable measurement result in basic measuring unit**

Format: **S CR LF**

Response options:

- S\_A CR LF - command understood and in progress
- S\_E CR LF - time limit exceeded while waiting for stable measurement result
- S\_I CR LF - command understood but not accessible at this moment
- MASS FRAME - response: mass value in basic measuring unit

Response format:

1	2-3	4	5	6	7-15	16	17	18	19	20	21
S	space	stability marker	space	character	mass	space	unit			CR	LF

**Example:**

- S CR LF** - command sent from a computer
- S \_ A CR LF** - command understood and in progress
- S \_ \_ \_ \_ - \_ \_ \_ \_ \_ 8 . 5 \_ g \_ \_ CR LF** - command carried out, response: mass value in basic measuring unit

where: \_ - space

**Immediately Send Measurement Result in Basic Measuring Unit**

Format: **SI CR LF**

Response options:

- SI\_I CR LF - command understood but not accessible at this moment
- MASS FRAME - command carried out, immediate response: mass value in basic measuring unit

Response format:

1	2	3	4	5	6	7-15	16	17	18	19	20	21
S	I	space	stability marker	space	character	mass	space	unit			CR	LF

**Example:**

- S I CR LF** - command sent from a computer
- S I \_ ? \_ \_ \_ \_ \_ 1 8 . 5 \_ k g \_ CR LF** - command carried out, immediate response: mass value in basic measuring unit

where: \_ - space

### Send Stable Measurement Result in Current Measuring Unit

Format: **SU CR LF**

Response options:

SU\_A CR LF - command understood and in progress

SU\_E CR LF - time limit exceeded while waiting for stable measurement result

SU\_I CR LF - command understood but not accessible at this moment

MASS FRAME - response: mass value in basic measuring unit

Response format:

1	2	3	4	5	6	7-15	16	17	18	19	20	21
S	U	space	stability marker	space	character	mass	space	unit			CR	LF

**Example:**

**S U CR LF** - command sent from a computer

**S U \_ A CR LF** - command understood and in progress

**S U \_ \_ \_ - \_ \_ 1 7 2 . 1 3 5 \_ N \_ \_ CR LF** - command carried out, response: mass value in current measuring unit.

where: \_ - space

### Immediately Send Measurement Result in Current Measuring Unit

Format: **SUI CR LF**

Response options:

SUI\_I CR LF - command understood but not accessible at this moment

MASS FRAME - command carried out, immediate response: mass value in basic measuring unit

Response format:

1	2	3	4	5	6	7-15	16	17	18	19	20	21
S	U	I	stability marker	space	character	mass	space	unit			CR	LF

**Example:**

**S U I CR LF** - command sent from a computer

**S U I ? \_ - \_ \_ \_ 5 8 . 2 3 7 \_ k g \_ CR LF** - command carried out, response: mass value in basic measuring unit

where: \_ - space

### Switch on Continuous Transmission in Basic Measuring Unit

Format: **C1 CR LF**

Response options:

C1\_I CR LF - command understood but not accessible at this moment

C1\_A CR LF - command understood and in progress

MASS FRAME - response: mass value in basic measuring unit

Response format:

1	2	3	4	5	6	7-15	16	17	18	19	20	21
S	I	space	stability marker	space	character	mass	space	unit			CR	LF

### Switch off Continuous Transmission in Basic Measuring Unit

Format: **C0 CR LF**

Response options:

C0\_I CR LF - command understood but not accessible at this moment

C0\_A CR LF - command understood and carried out

### Switch on Continuous Transmission in Current Measuring Unit

Format: **CU1 CR LF**

Response options:

CU1\_I CR LF - command understood but not accessible at this moment

CU1\_A CR LF - command understood and in progress

MASS FRAME - response: mass value in current measuring unit

Response format:

1	2	3	4	5	6	7-15	16	17	18	19	20	21
S	U	I	stability marker	space	character	mass	space	unit			CR	LF

### Switch off Continuous Transmission in Current Measuring Unit

Format: **CU0 CR LF**

Response options:

CU0\_I CR LF - command understood but not accessible at this moment

CU0\_A CR LF - command understood and carried out

### Set Min Checkweighing Threshold

Format: **DH\_XXXXX CR LF**, where: \_ - space, **XXXXX** - mass format

Response options:

DH\_OK CR LF - command carried out

ES CR LF - command not recognised (mass format incorrect)

### Set Max Checkweighing Threshold

Format: **UH\_XXXXX CR LF**, where: \_ - space, **XXXXX** - mass format

Response options:

UH\_OK CR LF - command carried out

ES CR LF - command not recognised (mass format incorrect)

### Give value of min checkweighing threshold

Format: **ODH CR LF**

Response: **DH\_MASS CR LF** - command carried out

Response format:

1	2	3	4-12	13	14	15	16	17	18	19
D	H	space	mass	space	unit			space	CR	LF

**Mass** - 9 characters, right justification

**Unit** - 3 characters, left justification

### Give Value of Max Checkweighing Threshold

Format: **OUH CR LF**

Response: **UH\_MASS CR LF** - command carried out

Response format:

1	2	3	4-12	13	14	15	16	17	18	19
U	H	space	mass	space	unit		space	CR	LF	

**Mass** - 9 characters, right justification

**Unit** - 3 characters, left justification

### Set Mass Value of a Single Item (for PARTS COUNTING mode exclusively)

Format: **SM\_XXXXX CR LF**, where: \_ - space, **XXXXX** - mass format

Response options:

SM\_OK CR LF - command carried out

SM\_I CR LF - command understood but not accessible at this moment (e.g. other than PARTS COUNTING mode operated)

ES CR LF - command not recognised (mass format incorrect)

### Set Target Mass Value (e.g. for DOSING mode)

Format: **TV\_XXXXX CR LF**, where: \_ - space, **XXXXX** - mass format

Response options:

TV\_OK CR LF - command carried out

TV\_I CR LF - command understood but not accessible at this moment (e.g. WEIGHING mode operated)

ES CR LF - command not recognised (mass format incorrect)

### Set Reference Mass Value (e.g. for PERCENT WEIGHING mode)

Format: **RM\_XXXXX CR LF**, where: \_ - space, **XXXXX** - mass format

Response options:

RM\_OK CR LF - command carried out

RM\_I CR LF - command understood but not accessible at this moment (e.g. other than PERCENT WEIGHING mode operated)

ES CR LF - command not recognised (mass format incorrect)

### Value Release

Format: **SS CR LF**

Response options:

SS\_OK CR LF - command understood and in progress

Command's function is similar to function of PRINT key located on the balance panel.

### Internal Adjustment

Format: **IC CR LF**

Response options:

IC\_A CR LF - command understood and in progress

IC\_D CR LF - adjustment completed

IC\_A CR LF - command understood and in progress

IC\_E CR LF - time limit exceeded while waiting for a stable measurement result

IC\_I CR LF - command understood but not accessible at this moment

### Disable Automatic Internal Adjustment of the Balance

Format: **IC1 CR LF**

Response options:

IC1\_I CR LF - command understood but not accessible at this moment

IC1\_E CR LF - operation disabled, e.g. for verified balance

IC1\_OK CR LF - command carried out

Operation is disabled for verified balances.

For non-verified balances the command disables internal adjustment until it is enabled via IC0 command or until the balance is turned off. The command does not modify settings specifying adjustment start.

### Enable Automatic Internal Adjustment of the Balance

Format: **IC0 CR LF**

Response options:

IC0\_I CR LF - command understood but not accessible at this moment

IC0\_OK CR LF - command carried out

Operation is disabled for verified balances.

### Give Balance Serial Number

Format: **NB CR LF**

Response options:

NB\_A\_ "x" CR LF - command understood, response: serial number

NB\_I CR LF - command understood but not accessible at this moment

**x** - balance serial number (in between inverted commas)

Example:

Command: NB CR LF - return serial number

Response: NB\_A\_ "1234567" - balance serial number: "1234567"

### Lock Balance Keypad

Format: **K1 CR LF**

Response options:

K1\_I CR LF - command understood but not accessible at this moment

K1\_OK CR LF - command carried out

Command locks the balance keypad (proximity sensors, touch panel) until the moment of turning the balance off or until sending K0 command.

### Unlock Balance Keypad

Format: **K0 CR LF**

Response options:

K0\_I CR LF - command understood but not accessible at this moment

K0\_OK CR LF - command carried out

### Give Available Working Modes

Command overview:

Command returns accessible working modes.

Format: **OMI <CR><LF>**

Response options:

OMI <CR><LF>

n\_ "Mode name" <CR><LF>

: - command carried out, response: accessible working modes

n\_ "Mode name" <CR><LF>

OK <CR><LF>

OMI\_I <CR><LF> - command understood but not accessible at this moment

**Mode name** - parameter, working mode name, inserted in between inverted commas. The name takes form given on a particular balance display, it is provided in a currently selected language.

**n** - parameter, decimal value determining working mode number.

- n →
- 1 – Weighing
  - 2 – Parts Counting
  - 3 – Percent Weighing
  - 4 – Dosing
  - 5 – Formulations
  - 6 – Animal Weighing
  - 8 – Solids Density
  - 9 – Liquids Density
  - 10 – Peak Hold
  - 12 – Checkweighing
  - 13 – Statistics

**Caution:**

Working modes numbering is identical for each kind of balance or scale. The numbers are assigned to working modes names.

Some balances give only the number as a response.

**Example 1:**

Command: OMI <CR><LF> - give available working modes  
 Response: OMI <CR><LF>  
 2\_” Parts counting” <CR><LF> - response: accessible working modes  
 4\_” Dosing” <CR><LF> mode number + name  
 12\_” Checkweighing” <CR><LF>  
 OK <CR><LF> - command carried out

**Example 2:**

Command: OMI <CR><LF> - give available working modes  
 Response: OMI <CR><LF>  
 2 <CR><LF> - response: accessible working modes  
 4 <CR><LF>  
 12 <CR><LF>  
 OK <CR><LF> - command carried out

**Set Working Mode**

Command overview:

Command sets particular working mode.

Format: **OMS\_n <CR><LF>**

Response options:

OMS\_OK <CR><LF> - command carried out  
 OMS\_E <CR><LF> - error in-course of command execution, no parameter or incorrect format  
 OMS\_I <CR><LF> - command understood but not accessible at this moment

n - parameter, decimal value determining working mode number. To see detailed description go to OMI command.

Example:

Command: OMS\_13<CR><LF> - set Statistics mode  
 Response: OMS\_OK<CR><LF> - Statistics mode set

**Give Current Working Mode**

Command overview:

Command returns current working mode for a given balance.

Format: **OMG <CR><LF>**

Response options:

OMG\_n\_OK <CR><LF> - command carried out, response: current working mode

OMG\_I <CR><LF> - command understood but not accessible at this moment  
n - parameter, decimal value determining working mode number. To see detailed description go to OMI command.

Example:

Command: OMG<CR><LF> - return current working mode

Response: OMG\_13\_OK<CR><LF> - Statistics mode operated

### Give Accessible Units

Command overview:

Command returns units available for a particular balance and for a current working mode.

Format: UI <CR><LF>

Response options:

UI\_”x<sub>1</sub>,x<sub>2</sub>, ... x<sub>n</sub>”\_OK<CR><LF> - command carried out, response: accessible units

UI\_I <CR><LF> - command understood but not accessible at this moment

x - unit symbols, separated by means of commas.

x → g, mg, ct, lb, oz, ozt, dwt, tlh, tls, tlt, tlc, mom, gr, ti, N, baht, tola, u1, u2

Example:

Command: UI <CR><LF> - return available units

Response: UI\_”g, mg, ct”\_OK<CR><LF> - response: available units

### Set Current Unit

Command overview:

Command sets current unit for a particular device.

Format: US\_x <CR><LF>

Response options:

US\_x\_OK <CR><LF> - command carried out, response: currently set unit

US\_E <CR><LF> - error in-course of command execution, no parameter or incorrect format

US\_I <CR><LF> - command understood but not accessible at this moment

x - parameter, units symbols: g, mg, ct, lb, oz, ozt, dwt, tlh, tls, tlt, tlc, mom, gr, ti, N, baht, tola, msg, u1, u2, next.

**Caution:**



If x=next, the command swaps to adjacent unit available on the list (it simulates either 'unit' button pressing or pressing of unit field displayed in mass window).

Example:

Command: US\_mg<CR><LF> - set „mg” unit

Response: US\_mg\_OK<CR><LF> - „mg” set as a current unit

### Give Current Unit

Command overview:

Command returns current unit.

Format: UG <CR><LF>

Response options:

UG\_x\_OK<CR><LF> - command carried out, response: currently set unit

UG\_I <CR><LF> - command understood but not accessible at this moment

x - parameter, units symbols



Example:

Command: UG<CR><LF> - return current unit  
Response: UG\_ct\_OK<CR><LF> - currently set unit is „ct”

### Activate Sound Signal

Command overview:

Command activates BEEP sound signal for a specified amount of time.

Format: **BP\_TIME** <CR><LF>

Response options:

BP\_OK <CR><LF> - command carried out, BEEP activated

BP\_E” <CR><LF> - no parameter or incorrect format

BP\_I <CR><LF> - command understood but not accessible at this moment

**TIME** - parameter, decimal value specifying how long shall the sound last, parameter given in [ms].

Recommended range <50 ÷ 5000>.

If value greater than the permissible high limit is given, then BEEP sound is operated for the maximum permissible amount of time.

Example:

Command: BP\_350<CR><LF> BP\_350<CR><LF> - activate BEEP for 350 ms

Response: BP\_OK<CR><LF> - BEEP activated

#### Caution:

BEEP sound activated via BP command is inhibited if in-course of its activation the sound gets activated by means of other device: keypad, touch panel, proximity sensors.

### Send All Implemented Commands

Format: **PC CR LF**

Command: **PC CR LF** - send all implemented commands

Response: **PC\_A\_”Z,T,S,SI...”** - command carried out, all implemented commands have been sent.

### Give Balance Type

Format: **BN** <CR><LF>

Response options:

BN\_A\_”x” <CR><LF> - command understood, response: balance type

BN\_I <CR><LF> - command understood but not accessible at this moment

**x** - balance series (inserted in between inverted commas), with general balance type in front.

Example:

Command: BN <CR><LF> - give balance type

Response: BN\_A\_”AS” - balance type - ”XA 4Y”

### Give Max Capacity

Format: **FS** <CR><LF>

Response options:

FS\_A\_”x” <CR><LF> - command understood, response: Max capacity

FS\_I <CR><LF> - command understood but not accessible at this moment

**x** - Max capacity value (in between inverted commas).

Example:

Command: FS <CR><LF> - return Max capacity

- Max capacity: ”220 g”.

Response: FS\_A\_”220.0000”

## Give Program Version

Format: **RV <CR><LF>**

Response options:

RV\_A "x" <CR><LF> - command understood, response: program version

RV\_I <CR><LF> - command understood but not accessible at this moment

**x** - program version (in between inverted commas).

Example:

Command: RV <CR><LF> - return program version

Response: RV\_A " 1.1.1" - program version - "1.1.1"

## Set AUTOZERO Function

Format: **A\_n <CR><LF>**

Response options:

A\_OK <CR><LF> - command carried out

A\_E <CR><LF> - error in-course of command execution, no parameter or incorrect format

A\_I <CR><LF> - command understood but not accessible at this moment

**n** - parameter, decimal value determining autozero settings:

n → 0 – autozero off

1 – autozero on

### Caution:

Command changes settings for a current working mode.

Example:

Command: A\_1<CR><LF> - turn autozero function on

Response: A\_OK<CR><LF> – autozero on

AUTOZERO function operates until it is turned off by A0 command.

## Set Ambient Conditions State

Format: **EV\_n <CR><LF>**

Response options:

EV\_OK <CR><LF> - command carried out

EV\_E <CR><LF> - error in-course of command execution, no parameter or incorrect format

EV\_I <CR><LF> - command understood but not accessible at this moment

**n** - parameter, decimal value determining ambient conditions state.

n → 0 – unstable ambient conditions

1 – stable ambient conditions

### Caution:

Command changes settings for a current working mode.

Example:

Command: EV\_1<CR><LF> - set value 'stable' for ambient conditions option

Response: EV\_OK<CR><LF> - value 'stable' set for ambient conditions option

<AMBIENT CONDITIONS> parameter is set to value <STABLE> until command EV 0 swaps it to value <UNSTABLE>.

## Give Set Ambient Conditions

Command overview:

Information on currently set ambient conditions state is returned.

Format: **EVG <CR><LF>**

Response options:

**EVG\_x\_OK<CR><LF>** - command carried out, response: currently set ambient conditions state

**EVG\_I <CR><LF>** - command understood but not accessible at this moment

**x** - parameter, currently set ambient conditions state symbol

Example:

Command:           EVG<CR><LF>                   - send set ambient conditions

Response:           EVG\_0\_OK<CR><LF>               - currently set ambient conditions state symbol

### Set Filter

Format: **FIS\_n <CR><LF>**

Response options:

**FIS\_OK <CR><LF>**           - command carried out

**FIS\_E <CR><LF>**           - error in-course of command execution, no parameter or incorrect format

**FIS\_I <CR><LF>**           - command understood but not accessible at this moment

**n** - parameter, decimal value determining filter number.

n → 1 – very fast  
       2 – fast  
       3 – average  
       4 – slow  
       5 – very slow

#### Caution:

The numbering is assigned to a particular filter name and it is identical for all balance types. If for a particular balance type, filter settings are assigned to a working mode, the command changes the current mode's settings.

Example:

Command:           FIS\_3<CR><LF>               - set average filter

Response:           FIS\_OK<CR><LF>             - average filter set

### Give Set Filter

Command overview:

Information on currently set filter is returned.

Format: **FIG <CR><LF>**

Response options:

**FIG\_x\_OK<CR><LF>**           - command carried out, response: currently set filter

**FIG\_I <CR><LF>**           - command understood but not accessible at this moment

**x** - parameter, currently set filter symbol

Example:

Command:                                   FIG<CR><LF>               - give current filter

Response:                                  FIG\_2\_OK<CR><LF>       - average filter set

### Set Value Release

Format: **ARS\_n <CR><LF>**

Response options:

**ARS\_OK <CR><LF>**           - command carried out

**ARS\_E <CR><LF>**           - error in-course of command execution, no parameter or incorrect format

**ARS\_I <CR><LF>**           - command understood but not accessible at this moment

**n** - parameter, decimal value determining value release options.

n → 1 – fast  
       2 – fast + reliable

3 – reliable

**Caution:**

The numbering is assigned to a particular value release option and it is identical for all balance types. If for a particular balance type, value release settings are assigned to a working mode, the command changes the current mode's settings.

Example:

Command:           ARS\_2<CR><LF>           - set value release parameter to fast+reliable option  
Response:           ARS\_OK<CR><LF>           - fast+reliable option set

**Give Set Value Release**

Command overview:

Information on currently set value release option.

Format: **ARG <CR><LF>**

Response options:

**ARG\_x\_OK<CR><LF>**           - command carried out, set value release option is sent

**ARG\_I <CR><LF>**           - command understood but not accessible at this moment

**x** - parameter, decimal value determining value release options

Example:

Command:    ARG<CR><LF>           - send currently set value release option  
Response:    ARG\_2\_OK<CR><LF>       - currently set value release option: fast+reliable

**Set Last Digit**

Format: **LDS\_n <CR><LF>**

Response options:

LDS\_OK <CR><LF>           - command carried out

LDS\_E <CR><LF>           - error in-course of command execution, no parameter or incorrect format

LDS\_I <CR><LF>           - command understood but not accessible at this moment

**n** - parameter, decimal value determining last digit settings.

n → 1 – always  
      2 – never  
      3 – when stable

**Caution:**

The numbering is assigned to a particular last digit option and it is identical for all balance types. If for a particular balance type, value release settings are assigned to a working mode, the command changes the current mode's settings.

Example:

Command:           LDS\_1<CR><LF>           - set last digit option to value <Always>  
Response:           LDS\_OK<CR><LF>       - <Always> value set

**User Logging**

Format: **LOGIN\_Name, Password CR LF**

where: \_ - space (enter name and password in a form provided by the balance – *lower-case letters and upper-case letters*).

Response options:

LOGIN OK CR LF           - command understood, new operator logged in

LOGIN ERROR CR LF       - command understood, an error in name or password occurred, log in failed

ES CR LF               - command not recognized (format error)

**User Logout**

Format: **LOGOUT CR LF**

Response options:

LOGOUT OK CR LF - command understood, operator is logged out

ES CR LF - command not recognized (format error)

### Give Profile Name

Format: **PRG CR LF**

Response options:

PRG\_A\_”x” CR LF - command understood, response: profile name

PRG\_I CR LF - command understood but not accessible at this moment

**x** - profile name (in between inverted commas).

Example:

Command: **PRG CR LF** - give profile name

Response: **PRG\_A\_”Fast”** – profile name --”Fast”

### Set Balance Profile

Format: **PROFILE\_Name CR LF**

where: **\_** - space (enter name in a form provided by the balance – lower-case letters, upper-case letters and spaces, e.g. Fast; Fast dosing, User, Precision).

Response options:

PROFILE OK CR LF - command understood, new PROFILE set

LOGIN ERROR CR LF - command understood, an error in PROFILE name, log in failed

ES CR LF - command not recognized (format error)

### Give Accessible Units

Command overview:

Command returns units available for a particular balance and for a current working mode.

Format: **UI <CR><LF>**

Response options:

**UI\_”x<sub>1</sub>,x<sub>2</sub>, ... x<sub>n</sub>”\_OK<CR><LF>** - command carried out, response: accessible units

**UI\_I <CR><LF>** - command understood but not accessible at this moment

**x** - unit symbols, separated by means of commas

**x** → g, mg, ct, lb, oz, ozt, dwt, tlh, tls, tlt, tlc, mom, gr, ti, N, baht, tola, u1, u2

Example:

Command: **UI <CR><LF>** - return available units

Response: **UI\_”g, mg, ct”\_OK<CR><LF>** - response: available units

### Set Current Unit

Command overview:

Command sets current unit for a particular device.

Format: **US\_x <CR><LF>**

Response options:

**US\_x\_OK <CR><LF>** - command carried out, response: currently set unit

**US\_E <CR><LF>** - error in-course of command execution, no parameter or incorrect format

**US\_I <CR><LF>** - command understood but not accessible at this moment

**x** - parameter, units symbols: g, mg, ct, lb, oz, ozt, dwt, tlh, tls, tlt, tlc, mom, gr, ti, N, baht, tola, msg, u1, u2, next

**Caution:**

If x=next, the command swaps to adjacent unit available on the list (it simulates either 'unit' button pressing or pressing of unit field displayed in mass window).

Example:

Command: US\_mg<CR><LF> - set „mg” unit  
 Response: US\_mg\_OK<CR><LF> - „mg” set as a current unit

**Give Current Unit**

Command overview:

Command returns current unit.

Format: **UG <CR><LF>**

Response options:

**UG\_x\_OK<CR><LF>** - command carried out, response: currently set unit

**UG\_I <CR><LF>** - command understood but not accessible at this moment

**x** - parameter, units symbols

Example:

Command: UG<CR><LF> - return current unit  
 Response: UG\_ct\_OK<CR><LF> - currently set unit is „ct”

**Cooperation with PUE 7.1, PUE 10 Indicators**

Format: **NT CR LF**

Response options:

ES CR LF - command not recognised (mass format incorrect)

MASS FRAME - response: mass value in basic measuring unit

Response format:

1	2	3	4	5	6	7	8	9-18	19	20-22	23	24-32	33	34-36	37	38	39	40
N	T	space	stability marker	zero marker	range marker	last digit marker	space	mass	space	mass unit	space	tare	space	tare unit	space	hidden digits quantity	CR	LF

**NT** - command

**Stability marker** - [space] if stable, [?] if unstable

**Zero marker** - [space] for any value but zero, [Z] for zero value

**Range marker** - mark of range within which mass value is comprised: [space] I-range balance, [2] II-range balance, [3] III-range balance

**Last digit marker** - [zero] no digit, [1] one digit, [2] two digits, [3] three digits, [4] four digits, [5] five digits

**Mass** - 10 characters for net mass given in adjustment unit (with dot and a floating “-“ sign, no last digit markers), right justification

**Mass unit** - 3 characters, left justification

**Tare** - 9 characters with dot - right justification (when floating tare gets turned off automatically then zero value is sent)

**Tare unit** - 3 characters, left justification

**Hidden digits quantity** - Number specifying quantity of hidden digits: [space] when no digits are hidden, [1] when 1 digit is hidden

**Example:**

**NT CR LF** - command sent from a computer

**N T \_ ? \_ \_ 0 \_ \_ \_ \_ - 5 . 1 1 3 \_ g \_ \_ \_ \_ \_ 0 . 0 0 0 \_ g \_ \_ \_ 0 CR LF**

- command carried out, response: mass value and remaining data

where: \_ - space

### 38.3. Manual Printout / Automatic Printout

It is possible to generate printouts either manually or automatically.

- Manual printout: wait for a stable indication and press  button.
- Automatic printout is generated automatically in accordance with parameters set for automatic printout (read section 14.7).

The content of a printout depends on settings of <Standard printout> parameter - <Weighing printout template> (read section 14.7).

#### Mass printout format:

1	2	3	4 -12	13	14	15	16	17	18
stability marker	space	character	mass	space	unit			CR	LF

Stability marker [space] if stable  
 [?] if unstable  
 [!] if air buoyancy compensation function is on  
 [^] if high limit is out of range  
 [v] if low limit is out of range

Character [space] for positive values  
 [-] for negative values

Mass 9 characters with decimal point, right justification

Unit 3 characters, left justification

**Example:**

**\_ \_ \_ \_ \_ 1 8 3 2 . 0 \_ g \_ \_ CR LF** - a printout generated, with reference to <Weighing printout template> settings, from a balance upon pressing  key:

N (measurements quantity)	<b>NO</b>	Universal variable 1 ... 5	<b>NO</b>
Date	<b>NO</b>	Net	<b>NO</b>
Time	<b>NO</b>	Tare	<b>NO</b>
Level status	<b>NO</b>	Gross	<b>NO</b>
Customer	<b>NO</b>	Current result	<b>NO</b>
Warehouse	<b>NO</b>	Supplementary unit	<b>NO</b>
Product	<b>NO</b>	Mass	<b>YES</b>
Packaging	<b>NO</b>	Non-standard printout	<b>NO</b>



### 39. PERIPHERAL DEVICES

The 4Y series balance can cooperate with the following peripheral devices:

- computer,
- KAFKA, EPSON receipt printer,
- PCL printer,
- additional display,
- barcode scanner,
- peripheral device operating in ASCII communication protocol.

### 40. ERROR MESSAGES



Max weighing threshold exceeded  
Unload the weighing pan



Min weighing threshold exceeded  
Install weighing pan



Zeroing out of range  
Press tarring button or restart the balance



Display capacity out of range  
Unload the weighing pan



Tarring out of range  
Press zeroing button or restart the balance



Start mass out of range  
Install weighing pan



Zeroing/tarring time out of range  
Weighing indication unstable

-no level-      Balance not levelled

-Err 100-      Weighing module restart

In process            An ongoing process in the course of which the indication may be unstable (automatic tablet feeder – the process of feeding tablet, or mass comparator – the process of change of load)

#### 41. ADDITIONAL EQUIPMENT

Type	Name
P0136	RS232 cable for KAFKA printer
P0151	RS232 cable for EPSON printer
KAFKA	Thermal printer
EPSON	Dot printer
	PCL Printer
WD- xx	Additional display housed in a plastic casing
CK-01	Transponder card reader
LS2208	Barcode scanner
AP2-1	Current loop input
SAL	Anti-vibration table for XA series balances
	PC keyboard

#### PC software:

- „LABEL EDITOR”
- „PW-WIN”
- „RAD-KEY”

#### 42. ANNEX A - Printout Variables

##### 42.1. List of Variables

**Caution!**

*Each defined variable must be inserted in between curly bracket: {x}, where x – variable number.*

List of variables defining non-standard printout templates and data displayed within the workspace:

Symbol	Description
{0}	Standard printout in an adjustment unit
{1}	Standard printout in a current unit
{2}	Date
{3}	Time
{4}	Date and time
{5}	Working mode
{6}	Net weight in a current unit
{7}	Net weight in an adjustment unit
{8}	Gross weight in an adjustment unit
{9}	Tare in an adjustment unit

{10}	Current unit
{11}	Adjustment unit
{12}	Min threshold
{13}	Max threshold
{15}	Statistics: Number
{16}	Statistics: Sum
{17}	Statistics: Average
{18}	Statistics: Minimum
{19}	Statistics: Maximum
{20}	Statistics: SDV
{21}	Statistics: D
{22}	Statistics: RDV
{26}	Result control
{27}	Value
{28}	Level status
{30}	Gross value
{31}	Weighing platform no.
{32}	Serial number
{33}	Reading unit
{34}	Range
{35}	Parts counting: Reference sample mass
{36}	Percent weighing: Reference mass
{38}	Universal variable: Name
{39}	Universal variable: Value
{43}	Net weight in a supplementary unit
{44}	Supplementary unit
{45}	Target value
{46}	Tolerance
{47}	Difference
{48}	Balance type
{50}	Product: Name
{51}	Product: Code
{52}	Product: EAN code

{53}	Product: Mass
{54}	Product: Tare
{55}	Product: Price
{56}	Product: Minimum
{57}	Product: Maximum
{58} <sup>2)</sup>	Product: PGC mode
{59}	Product: Shelf-life time in days
{60}	Product: VAT
{61}	Product: Date
{62}	Product: Expiry date
{63}	Product: Density
{64}	Product: Ingredients
{65}	Product: Description
{66}	Product: Tolerance
{75}	Operator: Name
{76}	Operator: Code
{77}	Operator: Permissions
{80}	Packaging: Name
{81}	Packaging: Code
{82}	Packaging: Mass
{85}	Customer: Name
{86}	Customer: Code
{87}	Customer: TIN
{88}	Customer: Address
{89}	Customer: Postal code
{90}	Customer: City
{91}	Customer: Discount
{100} <sup>2)</sup>	PGC Report: Batch number
{101} <sup>2)</sup>	PGC Report: Start date
{102} <sup>2)</sup>	PGC Report: End date
{103} <sup>2)</sup>	PGC Report: Result
{104} <sup>2)</sup>	PGC Report: Batch quantity
{105} <sup>2)</sup>	PGC Report: Measurements quantity
{106} <sup>2)</sup>	PGC Report: Value of T1 error

{107} <sup>2)</sup>	PGC Report: Value of 2T1 error
{108} <sup>2)</sup>	PGC Report: T1 errors quantity
{109} <sup>2)</sup>	PGC Report: Permissible T1 errors quantity
{110} <sup>2)</sup>	PGC Report: 2T1 errors quantity
{111} <sup>2)</sup>	PGC Report: Sum
{112} <sup>2)</sup>	PGC Report: Min
{113} <sup>2)</sup>	PGC Report: Max
{114} <sup>2)</sup>	PGC Report: Average
{115} <sup>2)</sup>	PGC Report: Average limit
{116} <sup>2)</sup>	PGC Report: Standard deviation
{117} <sup>2)</sup>	PGC Report: Measurements
{118} <sup>2)</sup>	PGC Report: Unit
{119} <sup>2)</sup>	PGC Report: Report no.
{120} <sup>2)</sup>	Average Tare Report: Date
{121} <sup>2)</sup>	Average Tare Report: Result
{122} <sup>2)</sup>	Average Tare Report: Standard deviation
{123} <sup>2)</sup>	Average Tare Report: 0.25T1
{124} <sup>2)</sup>	Average Tare Report: Measurements quantity
{125} <sup>2)</sup>	Average Tare Report: Measurements
{126} <sup>2)</sup>	Average Tare Report: Report no.
{130}	Warehouse: Name
{131}	Warehouse: Code
{132}	Warehouse: Description
{140}	Additional display: WD
{142}	Additional display: WWG
{143}	Hex
{144}	Hex UTF-8
{146}	Gross weight value in current unit
{147}	Tare in current unit
{150}	Epson printer: Paper crop
{151}	PCL printer: Form feed
{155}	Cooperation with RADWAG CONNECT

{165}	Formulation: Name
{166}	Formulation: Code
{167}	Formulation: Ingredients quantity
{168}	Formulation: Sum
{169}	Formulation: Ingredient
{170}	Formulation: Ingredient number
{175}	Formulation report: Start date
{176}	Formulation report: End date
{177}	Formulation report: Sum
{178}	Formulation report: Target value
{179}	Formulation report: Difference
{180}	Formulation report: Measurements quantity
{181}	Formulation report: Status
{182}	Formulation report: Measurements
{188}	IngredientTarget mass
{189}	IngredientDifference
{190} <sup>2)</sup>	Comparator: Report no.
{191} <sup>2)</sup>	Comparator: Start date
{192} <sup>2)</sup>	Comparator: End date
{193} <sup>2)</sup>	Comparator: Order number
{194} <sup>2)</sup>	Comparator: Test weight number
{195} <sup>2)</sup>	Comparator: Difference
{196} <sup>2)</sup>	Comparator: List of measurements
{197} <sup>2)</sup>	Comparator: Mean difference
{198} <sup>2)</sup>	Comparator: Standard deviation
{199} <sup>2)</sup>	Comparator: Cycles quantity
{200} <sup>2)</sup>	Comparator: Method
{201} <sup>2)</sup>	Comparator: Min temperature
{202} <sup>2)</sup>	Comparator: Max temperature
{203} <sup>2)</sup>	Comparator: Min humidity
{204} <sup>2)</sup>	Comparator: Max humidity
{205} <sup>2)</sup>	Comparator: Min pressure
{206} <sup>2)</sup>	Comparator: Max pressure
{207} <sup>2)</sup>	Comparator: Task
{208} <sup>2)</sup>	Comparator: Selected task

{209} <sup>2)</sup>	Comparator: Measurements
{210}	Adjustment history: Adjustment type
{211}	Adjustment history: Nominal mass
{212}	Adjustment history: Current mass
{213}	Adjustment history: Difference
{214}	Adjustment history: Temperature
{215}	Adjustment history: Level status
{216}	Adjustment history: Weighing platform no.
{219}	Adjustment history: Date and time of recently performed adjustment
{220} <sup>2)</sup>	Mass control: Start date
{221} <sup>2)</sup>	Mass control: End date
{222} <sup>2)</sup>	Mass control: Batch no.
{223} <sup>2)</sup>	Mass control: Average
{224} <sup>2)</sup>	Mass control: Standard deviation
{225} <sup>2)</sup>	Mass control: Reference sample quantity
{226} <sup>2)</sup>	Mass control: Measurements
{227} <sup>2)</sup>	Mass control: Report no.
{228} <sup>2)</sup>	Mass control: Number of T2M error
{229} <sup>2)</sup>	Mass control: Number of T1M error
{230} <sup>2)</sup>	Mass control: Number of T1P error
{231} <sup>2)</sup>	Mass control: Number of T2P error
{232} <sup>2)</sup>	Mass control: T2- threshold
{233} <sup>2)</sup>	Mass control: T1- threshold
{234} <sup>2)</sup>	Mass control: T1+ threshold
{235} <sup>2)</sup>	Mass control: T2+ threshold
{236} <sup>2)</sup>	Mass control: T2- threshold value
{237} <sup>2)</sup>	Mass control: T1- threshold value
{238} <sup>2)</sup>	Mass control: T1+ threshold value
{239} <sup>2)</sup>	Mass control: T2+ threshold value
{240} <sup>2)</sup>	Mass control: Average in percent (DX)
{241} <sup>2)</sup>	Mass control: Standard deviation in percent
{250}	Density: Start date
{251}	Density: End date
{252}	Density: Procedure
{253}	Density: Standard liquid



{254}	Density of standard liquid
{255}	Density: Temperature of standard liquid
{256}	Density: Sinkers volume
{257}	Density: Density determined
{258}	Density: Unit
{259}	Density: Sample no.
{260}	Density: Weighing 1
{261}	Density: Weighing 2
{263}	Density: Volume
{266}	Density: Mass of steel standard
{267}	Density: Mass of aluminium standard
{268}	Density: Density of steel standard
{269}	Density: Density of aluminium standard
{275}	Ambient conditions report: Date and time
{276}	Ambient conditions report: THB Temperature
{277}	Ambient conditions report: THB humidity
{278}	Ambient conditions report: Temperature 1
{279}	Ambient conditions report: Temperature 2
{280}	Ambient conditions report: THB pressure
{281}	Ambient conditions report: Air density
{282}	Ambient conditions report: Humidity
{283}	Ambient conditions report: Pressure
{285} <sup>2)</sup>	Mass comparator: Reference weights: Name
{286} <sup>2)</sup>	Mass comparator: Reference weights: Code
{287} <sup>2)</sup>	Mass comparator: Reference weights: Class
{288} <sup>2)</sup>	Mass comparator: Reference weights: Serial number
{289} <sup>2)</sup>	Mass comparator: Reference weights: Mass
{290} <sup>2)</sup>	Mass comparator: Reference weights: Set no.
{295}	Animal weighing: Threshold
{296}	Animal weighing: Averaging time
{300} <sup>2)</sup>	Tasks: Name
{301} <sup>2)</sup>	Tasks: Code
{302} <sup>2)</sup>	Tasks: Class
{303} <sup>2)</sup>	Tasks: Mass

{304} <sup>2)</sup>	Tasks: Order number
{305} <sup>2)</sup>	Tasks: Test weight number
{310}	Pipettes: Name
{311}	Pipettes: Code
{312}	Pipettes: Model
{313}	Pipettes Tips
{314}	Pipettes: Nominal volume
{315}	Pipettes: Minimum volume
{316}	Pipettes: Channels quantity
{317}	Pipettes: Type
{318}	Pipettes: Volume type
{319}	Pipettes: Tested volumes
{325}	Pipette calibration report: Serial no.
{326}	Pipette calibration report: Start date
{327}	Pipette calibration report: End date
{328}	Pipette calibration report: Measurements quantity
{329}	Pipette calibration report: Cooperation in accordance with ISO 8655
{330}	Pipette calibration report: Status
{331}	Pipette calibration report: Temperature
{332}	Pipette calibration report: Humidity
{333}	Pipette calibration report: Pressure
{334}	Pipette calibration report: Water temperature
{335}	Pipette calibration report: Z coefficient
{336}	Pipette calibration report: Statistics
{337}	Pipette calibration report: Measurements and statistics
{338}	Pipette calibration report: Channel no.
{340}	Pipette calibration report: Average volume
{341}	Pipette calibration report: Systematic error
{342}	Pipette calibration report: Random error
{343}	Pipette calibration report: Tested volume
{344}	Pipette calibration report: Systematic error [%]
{345}	Pipette calibration report: Random error [%]
{350}	Lot: Name

{351}	Lot: Code
{352}	Lot: Samples
{353}	Lot: Samples quantity
{355}	Sample: Name
{356}	Sample: Status
{357}	Sample: Tare
{358}	Sample: Temperature
{359}	Sample: Humidity
{360}	Sample: Pressure
{361}	Sample no.
{365}	Weighing B: Interval
{366}	Weighing B: Difference
{367}	Weighing B: Difference %
{368}	Weighing B: Residue %
{369}	Weighing B: Number
{375}	Differential weighing: Method
{380} <sup>2)</sup>	Drying program: Name
{381} <sup>2)</sup>	Drying program: Code
{385} <sup>2)</sup>	Drying mode
{386} <sup>2)</sup>	Drying mode parameters
{387} <sup>2)</sup>	Finish mode
{388} <sup>2)</sup>	Finish mode parameters
{389} <sup>2)</sup>	Drying report: Unit
{390} <sup>2)</sup>	Drying report: Printout interval
{395} <sup>2)</sup>	Moisture analyzer: Set temperature
{396} <sup>2)</sup>	Moisture analyzer: Current temperature
{397} <sup>2)</sup>	Moisture analyzer: Drying time
{398} <sup>2)</sup>	Moisture analyzer: Status
{399} <sup>2)</sup>	Moisture analyzer: Drying time and result
{400} <sup>2)</sup>	Moisture analyzer: Humidity content

{401} <sup>2)</sup>	Moisture analyzer: Dry content
{402} <sup>2)</sup>	Moisture analyzer: Humid/Dry ratio
{403} <sup>2)</sup>	Moisture analyzer: Heating source test – Power [%]
{405}	SQC: Batch number
{406}	SQC: Start date
{407}	SQC: End date
{408}	SQC: Batch quantity
{410}	SQC : Average
{411}	SQC : Standard deviation
{412}	SQC : Min
{413}	SQC : Max
{414}	SQC : Difference
{415}	SQC : Measurements
{416}	SQC : Mean [%]
{417}	SQC : Standard deviation [%]
{418}	SQC : T2- errors quantity
{419}	SQC : T1- errors quantity
{420}	SQC : T1+ errors quantity
{421}	SQC : T2+ errors quantity
{422}	SQC : T2- threshold
{423}	SQC : T1- threshold
{424}	SQC : T1+ threshold
{425}	SQC : T2+ threshold
{426}	SQC : T2- threshold value
{427}	SQC : T1- threshold value
{428}	SQC : T1+ threshold value
{429}	SQC : T2+ threshold value
{440}	Minimum sample weight: Name
{441}	Minimum sample weight: Reference tare
{442}	Minimum sample weight
{443}	Minimum sample weight: Status

**Caution! 2)** Variables are not operated by **Standard** software version.

## 42.2. Variables Formatting

You can format numeric variables, text variables and dates which are to be printed or displayed in the grey workspace.

### Formatting types:

- variables with left justification,
- variables with right justification,
- determining quantity of characters for printing / displaying,
- determining quantity of decimal places for numerical variables,
- converting the format of date and hour,
- converting numerical variables into EAN13 code
- converting numerical variables and date into EAN128 code

### Special formatting characters:





















Character	Description	Example
,	Sign separating variable from format item	<b>{7,10}</b> - Net weight value of fixed length (10 characters), given in an adjustment unit, right justification.
-	Either minus sign or left justification.	<b>{7,-10}</b> - Net weight value of fixed length (10 characters), given in an adjustment unit, left justification.
:	Either sign proceeding format item or time separator (i.e. hours, minutes and seconds).	<b>{7:0.000}</b> - Net weight value given in an adjustment unit, always with three decimal places; <b>{3:hh:mm:ss}</b> – Current time in format: hour : minute : second.
.	The first dot is recognized as separator of integer digit from decimal fraction digit. All but first dots are ignored.	<b>{55:0.00}</b> - Product's unit price always with two decimal places; <b>{17:0.0000}</b> – Measurements average, always with four decimal places;
<b>F</b>	Either sign formatting digits to a string of “-ddd.ddd...” format (where: d - single digit, minus - for negative value only) or determination of decimal places quantity.	<b>{7:F2}</b> - Net weight value given in an adjustment unit, always with two decimal places. <b>{7,9:F2}</b> - Net weight value of fixed length (9 characters), given in an adjustment unit, always with two decimal places, right justification.
<b>V</b>	Formatting mass and quantities being derivatives of mass in EAN13 code.	<b>{7:V6.3}</b> - Net mass in a form of EAN13 code (6-character code) with three decimal places.
<b>T</b>	Formatting mass and quantities being derivatives of mass in EAN128 code.	<b>{7:T6.3}</b> - Net mass in a form of EAN128 code with three decimal places.
/	Date separator separating days, months and years.	<b>{2:yy/MM/dd}</b> - Current date in format: year - month - day, where <b>yy</b> stand for two less meaningful characters of a year;
\	Sign “escape” deleting a formatting function from the following sign, so that it is recognized as text	<b>{2:yy\MMVdd}</b> – Current date in format: year / month / day. <b>{2:yy:MM:dd}</b> - Current date in format: year : month : day. Should „\” be used as a literal, insert \.





























### Formatted variables application:

CODE	DESCRIPTION
{7:V6.3}	Net weight value given in a form of EAN 13 code (6-character code)
{7:V7.3}	Net weight value given in a form of EAN 13 code (7-character

	code)
{27:V6.3}	Net amount due in a form of EAN 13 code (6-character code)
{27:V7.3}	Net amount due in a form of EAN 13 code (7-character code)
{7:T6.3}	Net weight value in EAN 128 code
{8:T6.3}	Gross weight value in EAN 128 code
{55:T6.2}	Product price in EAN 128 code
{2:yyMMdd}	Date in EAN 128 code
{61:yyMMdd}	Product date in EAN 128 code
{62:yyMMdd}	Product expiry date in EAN 128 code

### 43. ANNEX B – Programmable Buttons List

Pictogram	Name	Pictogram	Name
	Profiles		Open/close right door
	Adjustment		Open/close door
	Zero		Parameters
	Tare		Products
	Set tare		Warehouses
	Disable tare		Customers
	Enable tare		Help
	Packaging		Parts counting: Set part mass
	Print		Parts counting: Determine part mass
	Print header		Parts counting: Reference sample quantity - 5 pcs.
	Print footer		Parts counting: Reference sample quantity - 10 pcs.

	Units		Parts counting: Reference sample quantity - 20 pcs.
	Universal variable 1		Parts counting: Reference sample quantity - 50 pcs.
	Universal variable 2		Parts counting: Reference sample quantity - 100 pcs.
	Universal variable 3		Parts counting: Assign reference sample mass
	Universal variable 4		Pipettes
	Universal variable 5		Differential weighing: Series
	Checkweighing thresholds		Differential weighing: Sample
	Statistics		Differential weighing: Tare
	Add to statistics		Differential weighing: Weighing A
	Target value		Differential weighing: Weighing B
	Percent weighing: Give reference sample mass		Differential weighing: Weighing T + A
	Percent weighing: Set 100%		Differential weighing: Delete value
	Density: Solids Density		Differential weighing: Copy tare
	Density: Liquids density		Differential weighing: Add sample
	Density: Air density		Moisture analyzer: Drying program
	Animal weighing		Moisture analyzer: Drying process graph
	Formulations		Moisture analyzer: Sample description



	Formulation with multiplier		PGC: Ongoing control information
	Formulation with target mass		PGC: Control graph
	Formulation using out-of-database ingredients		Running working mode
	Formulation: Skip ingredient		Operators
	Confirm		Open/close left door
	Abort		

#### 44. ANNEX D - ZEBRA Printer Setting

Baud rate                    **9600 b/sec**  
Parity control               **none**  
Bits                            **8 bit**  
Stop bits                     **1 bit**

Information regarding RS 232, printed on a printout  
Serial port: **96, N, 8, 1**

Procedure for printing information printout and resetting printer parameters is to be found in ZEBRA printer manual.

#### 45. ANNEX E - Barcode Scanner Settings

1. For communication with barcode scanners, RADWAG balances use RS232 interfaces and simplex transmission (one-way direction), without handshaking. For this purpose, use of second line of the cable is sufficient. Used scanners should be equipped with RS232 interface, both hardware and software handshaking must be disabled.
2. Transmission parameters can be set for both weighing devices and scanners. For both devices the following parameters must comply: baud rate, data bits quantity, parity control, stop bits quantity: e.g. 9600,8,N,1 – baud rate 9600 bit/s, data 8-bits, no parity control, 1 stop bit.
3. Barcode scanners can send additional information apart from the expected barcode; e.g. symbology (type of barcode). Due to the fact that RADWAG devices and software do not use such information, it is advisable to disable it.
4. Some RADWAG systems can omit unnecessary information by using parameters that mark the beginning and the length of the code required to analysis.
5. A special protocol is required in order the code be received by RADWAG equipment. It is required to program an appropriate *prefix* and *suffix*. In RADWAG-adopted standard, the prefix is 01 sign (byte) hexadecimal format, the suffix is 0D sign (byte) hexadecimal format.
6. Most barcode scanners allow to enable/disable different symbologies (barcode types).

7. Programming of scanners is performed by reading special barcodes.

Barcode with required prefix and suffix in hexadecimal format	Barcode without required – fixes in ASCII format	Code type
01 30 30 32 31 30 31 32 36 0D	00210126	EAN-8
01 30 31 32 33 34 35 36 37 38 39 0D	0123456789	CODE 2 OF 5
01 43 4F 44 45 20 33 39 20 54 45 53 54 0D	CODE 39 Test	CODE 39
01 31 31 30 31 32 33 34 35 36 37 38 39 31 0D	1101234567891	EAN-13
01 43 6F 64 65 20 31 32 38 20 54 65 73 74 0D	CODE 128 Test	CODE 128

#### 46. ANNEX F – Menu Structure

##### User Adjustment

Description	Value
Internal adjustment	Function
External adjustment	Function
User adjustment	Function
Adjustment test	Function
Automatic adjustment time	1 - 12
Report printout	No / Yes
GLP Project. . →→	

Name	Setting
» Adjustment	No / Yes
» Working mode	No / Yes
» Date	No / Yes
» Time	No / Yes
» Operator	No / Yes
» Balance type	No / Yes
» Balance S/N	No / Yes
» Level status	No / Yes
» Nominal mass	No / Yes
» Difference	No / Yes
» Temperature	No / Yes
» Current mass	No / Yes
» Empty line	No / Yes
» Dashes	No / Yes
» Signature	No / Yes

	» Non-standard printout	No / Yes
Adjustment history	Display of a report on completed external adjustments	

## Databases

- Products
- Weighings
- Customers
- Formulations
- Formulations reports
- Density reports
- Controls
- Average tares
- Pipettes
- Pipette calibration reports
- Series
- Ambient conditions
- Packaging
- Warehouses
- Printouts
- Universal variables
- Clear older data
- Export weighing records database to a file

## Communication

Description	Value
COM 1	-
» Baud rate	9600
» Data bits	8
» Stop bits	1
» Parity	None
COM 2	-
» Baud rate	9600
» Data bits	8
» Stop bits	1
» Parity	None
Ethernet	-
» DHCP	No
» IP address	192.168.0.2
» Subnet mask	255.255.255.0
» Default gateway	192.168.0.1
TCP	-

Port	4001
------	------

## Peripherals

Description	Value
Computer	-
» Port	COM 1
» Address	1
» Continuous transmission	No / Yes
» Printout template	Settings
» E2R System	Settings
Printer	
» Port	COM 2
» Code page	1250
» Printouts	Settings
Barcode scanner	
» Port	None / COM 1/ COM 2
» Offset	0
» Code length	0
Transponder card scanner	
Port	None / COM 1/ COM 2
Additional display	
Port	None / COM 1-2 / TCP
Project	Settings
Ambient conditions module	
Port	None / COM 1-2 / Com internal
Address	3

## Inputs / Outputs

Description	Value
Inputs	
» Input 1	Option
» Input 2	Option
» Input 3	Option
» Input 4	Option
Outputs	

» Output 1	Option
» Output 2	Option
» Output 3	Option
» Output 4	Option

## Permissions

Description	Value
Anonymous operator	
» Guest	Option
» Operator	Option
» Advanced operator	Option
» Administrator	Option
Date and time	
» Guest	Option
» Operator	Option
» Advanced operator	Option
» Administrator	Option
Printouts	
» Guest	Option
» Operator	Option
» Advanced operator	Option
» Administrator	Option
Databases	
Products	Options: - Guest - Operator - Advanced operator - Administrator
Customers	
Formulations	
Packaging	
Warehouses	
Printouts	
Clear older data	

## Misc.

Description	Value
Language	Option
Date and time	Setting

Beep	Option
Touch panel calibration	Function
Level control	Option
Autotest	Option

*User manual number:  
IMMU-01-27-01-19-EN*



**RADWAG BALANCES AND SCALES**  
ADVANCED WEIGHING TECHNOLOGIES

